



SPORTi
FRANCE

**SPORTS
EQUIPMENT**
Catalogue



2026
2027

Our new products 2026

SportBeeper A new brand!

Ensure the sequential and sound management of exercises or tests with ease!

To discover on page 91



In this catalogue, we offer you new products: ball bags, children's pickleball rackets, LCD volleyball tablets... **and a new sport: pétanque!**

Discover all these items throughout the pages of the catalogue, or go straight to the essentials with our new products brochure.

NEW PRODUCTS



P.36
Foldable rebound board



P.132
Kid pickleball racket



P.42
Elite foldable aluminium mini goal



P.9
Foldable pétanque bag



P.57
Paint marking wheelbarrow



P.68
LCD volleyball tablet

**Find all our
latest products**
in our online brochure



CONTENT

SPORTS BAGS, STORAGE AND TRANSPORT

P3

Players bags	4
Equipment and Jerseys / Short bag	5
Little bags and coach	6
Rackets bags, slalom poles and javelin bags	7
Bags and nets for balls	8
Transport and storage	9

MULTISPORTS

P13

Training bibs	14
Scarf and flag belt	16
Training kits	17
Cones	18
Hoops	20
Markers	21
Floor making	22
Speed ladders and training slats	24
Slalom poles and bags for poles	25
Poles and bases	26
Precision arches, training kits and clips	27
Hurdles	28
Tchoukballs and inflatable dummies	30
Muscle-strengthening	31
Dummy and bases	32
Football targets	35
Rebound boards	36
Ball tennis sets and inflatable football goals	37
Mini goal, and football Flexi-Goal®	38
Handball target and reducer	44
Handball mini goals and baby-hand	45
Mini goals and Flexi-Goal® handball	46
Basketball goals	48
Petanque	50
Rugby and reinforcement	51
Cups, medals and podium	52

TRACING AND GROUND ACCESSORIES

P53

Corner poles and flags	54
Shoe brush and demarcation	55
Grass implants and tracing	56
Paint and marking spray	58

COACH, REFEREE AND PLAYER

P59

Resin, cleansing cream and cleaner	60
Bottles and cooler	61
Bottles carrier and bottles	62
Rigid briefcase and coach bag	64
Spiral notebooks and pro coaching boards	65
Coaching tablets	66
Taktifol	67
LCD coaching tablets	68
Tactic boards	70
Compressors, pumps and inflating accessories	72
Armbands	74
Measuring instruments and megaphone	76
Whistles	77
Fox 40 whistles and referee watch	78
Refereeing	80

STOPWATCHES AND DIGITAL DISPLAYS

P83

Stopwatches sets and cases	84
Student watches and chronometers	86

Teaching chronometers	88
Professional stopwatches and printers	90
SportBeeper	93
Multifunction display and LED panels	94

FIRST AID

P95

Cool box and first-aid bag	96
First-aid kit and bag CLUB	98
First-aid kit and bag PRO	99
Treatment kits	100
Cold or hot treatment	101
Gels and massage creams	102
Dressings, bandages and protections	104
Straps	105
Accessories and stretcher	106
Disinfection and measuring devices	107
Stretcher and treatment tables	108

FITNESS AND COMBAT

P109

Mats and mat holder	110
Yoga	112
Gymball, fitness roll, balls and special balls	113
Balance, proprioception and trampoline	114
Steppers	115
Muscle-strengthening	116
Skipping ropes	122
Hemp ropes	123
Boxing	124
Judo and Karate	125
Rhythmic gymnastics	126

SWIMMING

P127

Swind textile, caps and goggles	128
Accessories and training equipment	129

RACKET SPORTS

P131

Pickleball	132
Table tennis	136
Badminton	138
Badminton set, beachminton and speedbadminton	140
Tennis	141
Trolley for balls and mini-tennis kit	144

ATHLETICS

P145

Throwing introduction	146
Throwing and magnesita	147
Running: starting-blocks, hurdles and relays	148
Muscle-strengthening and speed ladders	149
Measuring devices, elastic jump cord and podium	151

BALLS

P151

Football, futsal, beach soccer	152
Basketball	154
Handball	155
Rugby and American football	156
Volleyball and water polo	157
Foam balls	158
"Elephant skin" balls	159
Educational balls	160
Giant balls and space hopper	162

SCHOOL

P163

Orienteering	164
Must-have for teacher	167
Hockey and street hockey	168
Juggling	170
Throwing games	172
Rackets games	174
Space hoopers and giant balls	175
Floor marking	176
Agility and precision kits	177
Playground and balance game	178
Road safety	180

NETS AND ACCESSORIES

P181

FOOTBALL	182
BASKETBALL	190
HANDBALL	194
VOLLEYBALL	197
TENNIS	200
BADMINTON	202
RUGBY	204
STADIUM EQUIPMENT	205

LEGENDS



News on 2026 catalogue



Made in France product



Within the limit of available stocks



Biodegradable product



UV-resistant product



Product not eligible for carriage free from €370 in Metropolitan France only. Delivery fees will be charged for these references.



Video available on our website.

CAPACITY 25 L

LENGTH 19 cm

Product characteristics

NEW IN 2026 THE ECO-BLOCK

The product contain recycled materials

RECYCLED

The product is recyclable (all or part)

RECYCLABLE

OUR COMMITMENTS

Aware of today's societal challenges and true to our values, we seek to give greater meaning to our commercial approach. That is why we integrate **a concrete commitment to the United Nations Sustainable Development Goals into each of our actions**. We focus our efforts on the goals that are directly linked to the challenges of our business.

WASTE VALORISATION

We work to reduce our waste production despite the growth of our business activity.

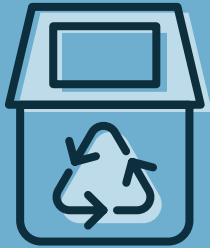

78% of our waste are recycled

-20% cardboard waste generated in 1 year

OUR EMPLOYEES



82% of our employees are on permanent contracts

11% of our workforce are apprentices. Training young people in the region is a strong value.

CUSTOMER SATISFACTION

Since 2024, we have been proud to be ISO 9001 certified, a globally recognised quality management standard.

This certification reflects our desire to improve our performance, meet our customers' expectations and demonstrates our commitment to quality.



RECYCLABILITY OF PRODUCTS



40% References are recyclable at over 95%

24% of our products contain recycled materials

**NEW IN 2026
THE ECO-BLOCK**

Find this information on each product page.



SUSTAINABLE ECONOMY



We are committed to build relationships of trust with both our customers and our suppliers. Mindful of our commitments in the region, we prioritise working with local service providers.



26% of our products are made in France



Sports bags, storage and transport

Players bags	4
Little bags and coach	5
Rackets bags, slalom poles and javelin bags	6
Equipment and jerseys/shorts bag	7
Bags and nets for balls	8
Transport and storage	9



P.8



P.9

PLAYERS BAGS

TROLLEY TEAM BAG



CUSTOMISABLE PRODUCT*
FROM 300 PIECES (ON QUOTATION)



+ 2 sides pockets

2 SIZES

Ct : 59 Litres		Ct : 77 Litres	
H.	30 cm	H.	32 cm
w.	32 cm	w.	34 cm
L.	61 cm	L.	71 cm

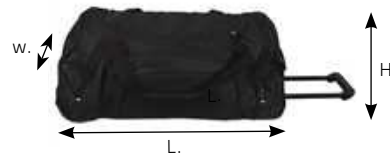

+ Ergonomic carry handle

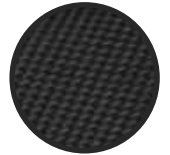

100% polyester 600 deniers reinforced



Integrated casters

100 % polyester bag reinforced 600 deniers for a greater resistance, large main compartment with a large U-shape opening with double zip, 2 side pockets and one pocket on the front face with a zip. With its casters and its retractable handle, this trolley becomes an excellent bag for player but also to transport equipment. A bag designed for clubs with an excellent value for money.

Reference: 078113	Size: 61cm / 59 Litres	Black	Dimensions: L. 61cm x H. 30cm x w. 32cm
Reference: 078114	Size: 71cm / 77 Litres	Black	Dimensions: L. 71cm x H. 32cm x w. 34cm

SPORTS BAG TEAM



CUSTOMISABLE PRODUCT*
FROM 300 PIECES (ON QUOTATION)



+ 2 sides pockets

+ Zippered pocket on the front face



Large strap to transport it and padded for greater comfort

+ Ergonomic carry handle

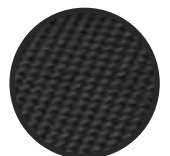

100% polyester 600 deniers reinforced

3 sizes

Ct : 42 Litres		Ct : 58 Litres		Ct : 76 Litres	
H.	28 cm	H.	30 cm	H.	32 cm
w.	30 cm	w.	32 cm	w.	34 cm
L.	50 cm	L.	60 cm	L.	70 cm

100 % polyester bag reinforced 600 deniers, large main compartment with a large opening in U form with double zips, 2 lateral pockets and one pocket on the front face with a zip. Adjustable and removable padded strap. A bag designed for clubs with an excellent value for money.

Reference: 078110	Size: 50cm / 42 Litres	Dimensions: L. 50cm x H. 28cm x w. 30cm
Reference: 078111	Size: 60cm / 58 Litres	Dimensions: L. 60cm x H. 30cm x w. 32cm
Reference: 078112	Size: 70cm / 76 Litres	Dimensions: L. 70cm x H. 32cm x w. 34cm

See more petanque products on page 50

BACKPACK



Openwork side pocket +



Bimaterial +

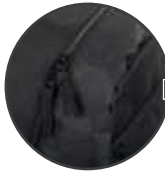

Padded straps and back +



CAPACITY	THICKNESS	WIDTH	HEIGHT
25 L	15 cm	30 cm	44 cm

Backpack with large main compartment, 2 side mesh pockets and a large front zippered pocket for small accessories. Padded back and carrying straps for greater comfort. Material: polyester. Colour: black with reflective stripes on front.

Reference: 078002

Unit

GYMBAG



CAPACITY	LENGTH	WIDTH
13 L	44 cm	34 cm

Polyester bag 210 deniers with cords and corners reinforced in PU. It can be used in different ways: backpack, shoe bag, toilet bag, etc. 5 colours available (Black, Red, Royal, Green and Navy).

Reference: 078096

Unit

MULTIFUNCTIONS BAG



2026 NEW New design



LENGTH	WIDTH	HEIGHT
35 cm	15 cm	17 cm

100% polyester multifunctions bag. It can serve as a shoes bag or as toiletry bag. Accessibility to the content greatly facilitated by its opening with double zip and hook and loop fastener. Colour: Black.

Reference: 078089

Unit

BAG FOR 3 PETANQUE BALLS



2026 NEW



LENGTH	WIDTH	HEIGHT
24 cm	9 cm	8 cm

Semi-rigid, highly sustainable petanque bag made of 600D polyester, designed to hold and protect your 3 balls. Features a flap with a double zip closure and a carry handle. Colour: Black. Delivered without ball.

Reference: 078003

Unit

PETANQUE SHOULDER BAG



2026 NEW



LENGTH	WIDTH	HEIGHT
16 cm	25 cm	30 cm

Shoulder bag featuring a large zippered compartment and a zippered pocket at the front. The lower part, with a height of 9cm, is equipped with padding that can hold and protect your 3 petanque balls and jacks. Material: 600D Polyester. Colour: Black. Delivered without ball.

Reference: 078004

Unit



RACKET BAGS AND STORAGE BAGS

BAG FOR TABLE TENNIS PADDLES

SSPORTI

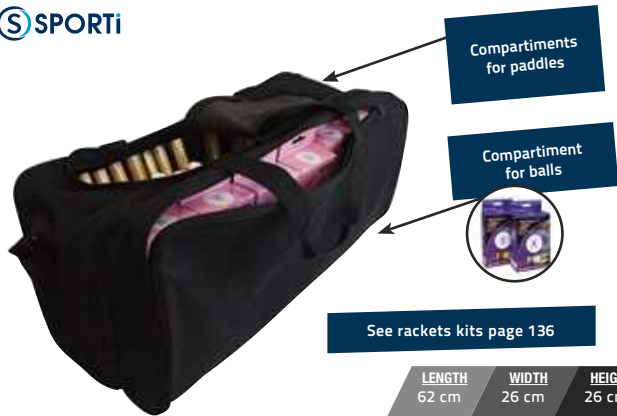

Compartments for paddles

Compartment for balls

See rackets kits page 136

LENGTH	WIDTH	HEIGHT
62 cm	26 cm	26 cm

Nylon canvas bag reinforced 600 deniers. It is composed of a large main compartment with an opening in U to easily store up to 40 table tennis paddles. Front pocket with a zip for ball storage and or other material (ex: 14 boxes of 6 balls). Adjustable handles and transport reinforced shoulder strap. Colour: black. Delivered without paddle and without ball/shuttlecock.

Reference: 014043

Unit

BAG FOR BADMINTON OR TENNIS PADDLES

SSPORTI



Compartment for rackets

Compartment for shuttlecocks / balls

See rackets kits page 139 and 143

LENGTH	WIDTH	HEIGHT
80 cm	48 cm	33 cm

Nylon canvas bag reinforced 600 deniers. It is composed of a large main compartment with an opening in U to easily store until 40 badminton rackets or 20 tennis rackets. Side pocket with opening in U to store the tubes for shuttlecocks (up to 10 tubes) or tubes for tennis balls (up to 6 tubes). Handles and adjustable transport and reinforced shoulder strap. Colour: black. Delivered without racket and without ball.

Reference: 011084

Unit

NET BAG

SSPORTI



See nets starting on page 181 to 205

Reinforcement strap

LENGTH	WIDTH	HEIGHT
80 cm	48 cm	33 cm

Nylon canvas bag reinforced 600 deniers. It is composed of a large main compartment with a U-shape opening to easily store your nets. Side pocket with U-shape opening. Handles and adjustable and reinforced transport shoulder strap. Colour: black. Delivered without net.

Reference: 011084

Unit

MULTISPORTS BAG

Sea



Especially suitable for transport of hoops, cones and poles

LENGTH	WIDTH	HEIGHT
105 cm	70 cm	35 cm

Multisport bag in nylon 600 deniers. Large capacity, it can easily store any kind of material: hoops, poles, mini-hurdles, balls etc. Colour: Black.

Reference: 078102

Unit

JAVELIN BAG

SSPORTI



DIAMETER	LENGTH
16.5 cm	276 cm

Bag to transport the javelins. For 15 javelins.

Reference: 078115

Unit

BAG FOR SLALOM POLES / POLES

SSPORTI



LENGTH	WIDTH	HEIGHT
185 cm	25 cm	25 cm

Reinforced nylon bag. Zip fastening. Thanks to its handles, this bag allows to easily transport up to 50 slalom poles.

Reference: 078063

Unit

EQUIPMENT BAG



+ 2 separate inside compartments aerated thanks to their mesh



+ Reinforced bottom thanks to its 3 reinforcement bars and its thicker structure



+ Telescopic and retractable handle

+ 2 carry handles

+ 2 large front pockets



+ PVC cover level with wheels

CUSTOMISABLE PRODUCT*
FROM 10 PIECES (ON QUOTATION)

CAPACITY	LENGTH	WIDTH	RECYCLED
			RECYCLABLE
102 L	77 cm	38 cm	HEIGHT
			35 cm

*1 customised logo. Our marked articles will be neither taken back nor exchanged.

100% polyester 1680D high quality and reinforced lining. Colour: Black.

Reference: 078049

Unit

JERSEY / SHORTS BAG



Plastic label holder

+ Adjustable shoulder strap



Can contain a set of 16 shirts and shorts

LENGTH	WIDTH	HEIGHT
45 cm	35cm	22 cm

100% Polyester 600 deniers reinforced with PVC. Holds 14 jerseys and 14 shorts. With plastic pocket with label on the front, inside mesh pocket and carrying handle. Large U-shaped opening for easy storage. Black colour.

Reference: 078001

Unit

Sports bags, storage and transport
Multisports
Tracing and ground accessories
Coach, referee and player
First-aid
Fitness, bodybuilding and gym
Swimming
Combat sports
Racket sports
Athletics
Balls
School
Nets and accessories

BAGS AND NETS FOR BALLS

CARRYING BALLS NET



Easy fastening with another colour cord



Braided net in polypropylene of 4mm diameter, simple mesh of 100 mm. Delivered without ball.

Reference: 078034	2/3 balls	WHITE
Reference: 078035	5/6 balls	BLUE
Reference: 078029	10/12 balls	YELLOW
Reference: 078030	15/20 balls	RED

BALLS BAG



Cap. 6-7 balls
H. 75 cm
w. 40 cm

Cap. 12-15 balls
H. 90 cm
w. 50 cm

Bag for balls in nylon canvas 600 deniers. It has a shoulder strap, a cord stopper and lateral ventilation net. Colour: Black. Delivered without ball.

Reference: 078026	Capacity 6-7 balls
Reference: 078028	Capacity 12-15 balls

EQUIPMENT BAG IN OPEN WEAVE FABRIC



Capacity
10 basketballs S7 or 13 football S5



LENGTH 100 cm
WIDTH 50 cm
HEIGHT 50 cm

For the transport of any kind of material (about 10 basketballs T7, mini goals, cones). Bag in open weave fabric with carry handles (model without shoulder strap). Mix of polypropylene and polyester. Blue colour. Delivered without ball.

Reference: 078037 Unit

BALL CARRYING BAG IN OPEN WEAVE FABRIC



Capacity
14 basketballs S7 or 18 footballs S5

WIDTH 90 cm
HEIGHT 110 cm

Ball carrying black bag in open weave fabric. Black colour. Delivered without ball.

Reference: 078101 Unit

RUGBY BALLS BAG



Easy closure by hook and loop + clip



Capacity
6 balls of size 5

WIDTH 32 cm
HEIGHT 115 cm

Bag for rugby balls in nylon canvas 600 deniers. It can contain 6 balls size 5. Easy opening due to its hook and loop fastener and clip. It has a shoulder strap to make transport easier. Colour: black. Delivered without ball.

Reference: 078024 Unit

BALL BAG (1 BALL)



2026 NEW



DIAMETER 26 cm
HEIGHT 26 cm

Ball bag suitable for all types of balls, featuring a polyester fabric base with a 26 cm diameter and a polyester mesh section 26 cm high. Equipped with a small carabiner on the bottom of the bag and a large side carabiner on a strap, it can easily be attached to a backpack, for example, to make transport easier. An inside zippered fabric pocket measuring 22 x 13 cm allows you to store keys, documents, or other small accessories. Colour: Black.

Reference: 078020 Unit

BAG FOR BALLS



Bag for balls in nylon canvas 600 deniers. It has a shoulder strap with an S zip for an easy use. Delivered without ball.

Reference: 078022A	75 x 29cm 3 balls
Reference: 078022B	115 x 29cm 5 balls

BALL BAG FOR MATCHES



CAPACITY 6 balls
LENGTH 73 cm
HEIGHT 50 cm

Carry bag in nylon 600 deniers. It has a shoulder strap and carry handles for your matches. Colour: Black. Delivered without ball.

Reference: 078109 Unit

• TROLLEY



Secured closing system of the door during transportation



4 bibs hanging system



Storage of long lengths (milestones/slalom stakes).



Door on the front side



Large wheels to roll even on greasy terrain



WEIGHT	LENGTH	WIDTH	HEIGHT
22 kg	61.5 cm	60 cm	113 cm



Whether for transporting balls or equipment, this trolley will be the ideal partner for your training. Very easy to handle and very practical with its front door and oversized wheels, you will have no trouble rolling it, even on grassy ground. Delivered disassembled.

Reference: 068009

Unit

• METALLIC BALL TROLLEY



WEIGHT	LENGTH	WIDTH	HEIGHT
36 kg	122 cm	61 cm	92 cm



This metal ball trolley allows to store up to 30 balls and any kind of material. Easy to handle with its multidirectional wheels. For greater safety, closing via padlock (not supplied). Delivered flat packed.

Reference: 068011

Unit

BALLS RACK



LENGTH	WIDTH	HEIGHT
105 cm	20 cm	135 cm



Balls storage rack equipped with 4 adjustable wheels to facilitate the movement. It allows to store at least 16 balls.

Reference: 069003

Unit

FOLDABLE TROLLEY FOR BALLS



Delivered with storage bag



103.5 cm

57 cm

CAPACITY	LENGTH	WIDTH	HEIGHT
20 balls	65 cm	65 cm	50 cm



Foldable trolley for balls to facilitate the tidying, on swivel castors. Adapted to any floor type.

Reference: 078036

Unit



• 1 DOOR HIGH STORAGE CABINET



+ Delivered assembled



Anti-theft cabinet in galvanized steel equipped with a door designed to be closed with a padlock (not supplied) and 4 wheels with a diameter of 100mm (2 fixed + 2 pivoting). Mesh 5x5 cm. Internal dimensions: L.66 x D.74 x H.164cm. Max load weight: 400kg. / Side opening 72cm. Sold without shelf (sold separately). Delivered assembled.

Reference: 068018
Reference: 068019

A The cabinet
B Single shelf

STORAGE SUITCASE (85L / 110L / 200L)



+ Hinged lid



85L.



110L.



+ Transport casters

200L.

Place for padlock on the 3 models

This storage suitcase robust and light allows an optimal storage of your sports equipment. With its hinged lid, its front casters and its handle, it is very easy to carry and to close.

Reference: 069249 L. 75 cm. / w. 45.3 cm. / H. 39 cm. 85L.
Reference: 069250 L. 85.5 cm. / w. 48.5 cm. / H. 39.5 cm. 110L.
Reference: 069251 L. 84.8 cm. / w. 61 cm. / H. 51.5 cm. 200L.

STORAGE BOX WITH COVER (20L / 50L)



+ Stackable



Robust plastic storage box. Stackable, your storage boxes allow you an easy-to-use storage of your material. Supplied with a black cover.

Reference: 069237A L. 39 cm. / w. 25 cm. / H. 23 cm. 20L.
Reference: 069237B L. 56 cm. / w. 41 cm. / H. 29.5 cm. 50L.

STORAGE BOX WITHOUT COVER (30L / 50L)



+ Stackable



Robust plastic storage box. Stackable, your storage boxes allow you an easy-to-use storage of your material.

Reference: 069238A L. 44.1 cm. / w. 34.5 cm. / H. 23.5 cm. 30L.
Reference: 069238B L. 56 cm. / w. 41 cm. / H. 29.5 cm. 50L.

• 2 DOORS LOW STORAGE CABINET

A



B



+ Delivered assembled

+ Shelf compatible with 2 doors storage cabinet 068020 and 068022

External dimensions			
WEIGHT	LENGTH	DEPTH	HEIGHT
59 kg	120 cm	83 cm	125 cm

RECYCLED
RECYCLABLE

Anti-theft low cabinet in galvanized steel equipped with 2 doors designed to be closed with a padlock (not supplied) and 4 wheels with a diameter of 100mm (2 fixed + 2 pivoting). 5 x 5cm mesh. Inside dimensions: L.114 x D.74x H.104cm. Outside dimensions: L.120 x D.83 x H.125cm. Max load weight: 400kg / Side opening 120cm. Sold without shelf (sold separately). / Delivered assembled.

- Reference: 068022 **A** The cabinet
- Reference: 068021 **B** Single shelf

• 2 DOORS HIGH STORAGE CABINET

A



B



+ Delivered assembled

+ Shelf compatible with 2 doors storage cabinet 068020 and 068022

External dimensions			
WEIGHT	LENGTH	DEPTH	HEIGHT
69 kg	122 cm	80 cm	187 cm

RECYCLED
RECYCLABLE

Anti-theft cabinet in galvanized steel equipped with 2 doors designed to be closed with a padlock (not supplied) and 4 wheels with a diameter of 125mm (2 fixed + 2 pivoting). Mesh 5 x 5cm. Internal dimensions: L.114 x D.74 x H.164cm. Max load weight: 720kg. / Side opening 120cm. Sold without shelf (sold separately). Delivered assembled.

- Reference: 068020 **A** The cabinet
- Reference: 068021 **B** Single shelf

Sports bags, storage and transport
Multisports
Tracing and ground accessories
Coach, referee and player
First-aid
Fitness, bodybuilding and gym
Swimming
Combat sports
Racket sports
Athletics
Balls
School
Nets and accessories

WALL HOOP HOLDER

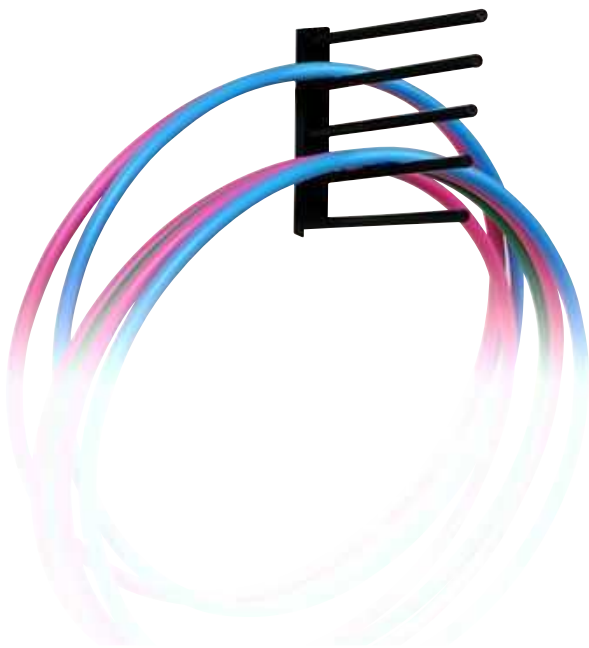

Lacquered metal support, can contain 5 diameters of different hoops. Capacity of 100 hoops.

Reference: 069001 Unit

ADJUSTABLE WALL MAT HOLDER

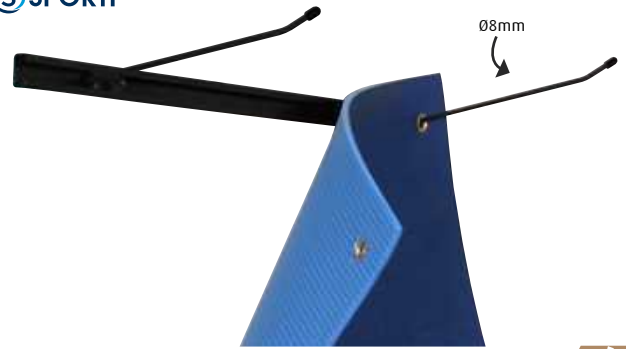

Wall mat holder, adjustable according to the space between the eyelets. Can contain up to 20 mats.

Reference: 043002 Unit

MOBILE MATS HOLDER



Mounted on 4 swivel castors, this support can contain about 40 mats (depending on their thickness). The width of the mat holder is adjustable to adapt it to the space between the eyelets (adjustment without tool). Supplied with a handle to move it. Floor space 69 x 61cm.

Reference: 043000 Unit

FOLDING MAT BAG



Can contain until 16 mats

LENGTH	WIDTH	HEIGHT
80 cm	48 cm	33 cm

Nylon canvas bag reinforced 600 deniers. It is composed of a large main compartment with a U-shape opening to easily store up to 16 folding mats (ref: 043015). Side pocket with U-shape opening. Handles and adjustable and reinforced transport shoulder strap. Colour: black. Delivered without mat.

Reference: 011084 Unit

Multisports

Training bibs	14
Scarf and flag belt	16
Training kits	17
Cones	18
Hoops	20
Markers	21
Floor marking	22
Speed ladders and training slats	24
Slalom poles and bags for poles	25
Poles and bases	26
Precision arches, training kits and clips	27
Hurdles	28
Tchoukballs and inflatable dummies	30
Muscle strengthening	31
Dummies and bases	32
Football targets	35
Rebound boards	36
Ball tennis sets, kit futnet and accessories	37
Mini goals and football Flexi-Goal®	38
Handball target and reducer	44
Handball mini goals	45
Mini-goals and Flexi-Goal® handball	46
Basketball goals and accessories	48
Petanque	50
Rugby and beach-volley	51
Cups, medals and podium	52

TO DISCOVER



P.34



P.36



P.39

REVERSIBLE TRAINING

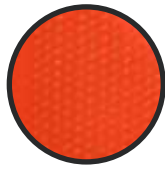

Openwork stitch
100% polyester



PURPLE
-
GREEN



ORANGE
-
YELLOW



RED
-
BLUE



BLACK
-
WHITE



CUSTOMISABLE PRODUCT*
FROM
300 PIECES
(on quotation)*

XXS Size	
H.	48 cm
w.	40 cm

XS Size	
H.	56 cm
w.	48 cm

M Size	
H.	66 cm
w.	55 cm

XL Size	
H.	76 cm
w.	60 cm

Reversible training bib with openwork stitches to increase breathability. 100 % polyester.

Reference: 063250

Unit

REVERSIBLE RUGBY TRAINING BIB



+ Lining braids

+ Double stitching with insertion of cord



CUSTOMISABLE PRODUCT*
FROM
300 PIECES
(on quotation)*

XS/S size	
H.	65 cm
w.	55 cm

M/L size	
H.	75 cm
w.	61 cm

XL/2XL size	
H.	82 cm
w.	64 cm



PVC TRAINING BIBS HOLDER



+ Good flexibility



+ Wide hook to easily hang bibs on a handrail: they do not lie on the floor.

Capacity
approximately 50 training bibs



Very strong and durable flexible PVC ring for bibs transportation and storage. The top hook makes it easy to hang the bibs on stadium handrails. Training bib compartment diameter: 14.5 cm

Reference: 069209

Unit

Reversible rugby training bib 100 % polyester interlock 180 gr, robust and stretch. Its composition (lining braids, double stitching with insertion of cord, reinforced braces and no seams on strategic places) makes it a perfect rugby bib. It is also appropriate for other sports.

Reference: 063310

Unit

TRAINING BIB



CUSTOMISABLE PRODUCT*
FROM 300 PIECES (on quotation)*

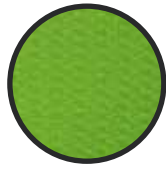

Openwork stitch
100% polyester
Weight 85/90g/m²



H.

w.

2026 NEW New size : 2XL/3XL



XXS Size	
H.	48 cm
w.	40 cm

XS size	
H.	56 cm
w.	48 cm

M size	
H.	66 cm
w.	55 cm

XL size	
H.	76 cm
w.	60 cm

2XL/3XL size	
H.	90 cm
w.	65 cm

Stretch fabric, soft touch, one of the best-valuable training bib of the market. 100% polyester. Available in 10 colours. Size 2XL/3XL available in Neon Yellow, Neon Orange, Red, Royal and Neon Green.

Reference: 063209

XXS to XL sizes - Unit

Reference: 063199

2XL/3XL size - only in Neon Yellow, Neon Orange, Red, Royal and Neon Green - Unit

SET OF REVERSIBLE NUMBERED TRAINING BIBS



Reversible

BLACK - WHITE

RED - BLUE



XS size	
H.	56 cm
w.	48 cm

M size	
H.	66 cm
w.	55 cm

XL size	
H.	76 cm
w.	60 cm

RECYCLABLE

Reversible training bib with openwork stitches to increase breathability. 100% polyester.

Reference: 063237 from 1 to 10 - set of 10 Black/White or Red/Blue

Reference: 063238 from 11 to 15 - set of 5 Black/White or Red/Blue

Reference: 063236 from 16 to 20 - set of 5 Black/White or Red/Blue

SET OF NUMBERED TRAINING BIBS



NEON GREEN



XS size	
H.	56 cm
w.	48 cm

M size	
H.	66 cm
w.	55 cm

XL size	
H.	76 cm
w.	60 cm

Stretchy and pleasant to the touch, 100% polyester. Sold in a pack of 10 numbered from 1 to 10 or in a pack of 5 numbered from 11 to 15 or from 16 to 20. Heart and back numbers. Available in 3 sizes (XS, M and XL) and 4 colours (Blue, Yellow, Red and Green).

Reference: 063120 from 1 to 10 - set of 10 yellow, red, green and Blue

Reference: 063122 from 11 to 15 - set of 5 yellow, red, green and Blue

Reference: 063123 from 16 to 20 - set of 5 yellow, red, green and Blue



Sports bags, storage and transport
Multisports
Tracing and ground accessories
Coach, referee and player
First-aid
Fitness, bodybuilding and gym
Swimming
Combat sports
Racket sports
Athletics
Balls
School
Nets and accessories

NYLON TRAINING BIB



Elastic strap

	XS size	S size	M size	L size
H.	49 cm	52 cm	56 cm	60 cm
w.	27 cm	29 cm	31 cm	35 cm

Light-nylon reinforced bib, with elastics and straps on each side. Available in 4 colours: blue, red, yellow and green.

Reference: 063116

Unit



PLAIN ARMBAND STRAP



See armands page 74-75

WIDTH	LENGTH
9 cm	35 cm

With elastic and large strap to increase comfort.

Reference: 063266	White
Reference: 063266	Neon Orange
Reference: 063266	Neon Yellow

SAFETY VEST



50-mm reflective strips. Loose-fit to wear the vest over the other clothes. L / XL size. 100% polyester.

Reference: 063453

Unit

FLAG BELT



STRAP	WAIST SIZE
41 cm	130 cm

Perfect for rugby initiation due to the 2 straps which enables to practice tackles. Adjustable belt with clips for better comfort. Available in 4 colours: Red, yellow, green and blue.

Reference: 063248

Unit

SCARF



Size
62 cm
62 cm
83 cm

Scarf: 80% polyester, 20% cotton, topstitched finish. Can also be used for multiple sports exercises.

4 available colours: blue, red, green and yellow.

Reference: 063219

Unit

KIT A «THE MUST-HAVES»

SPORTi

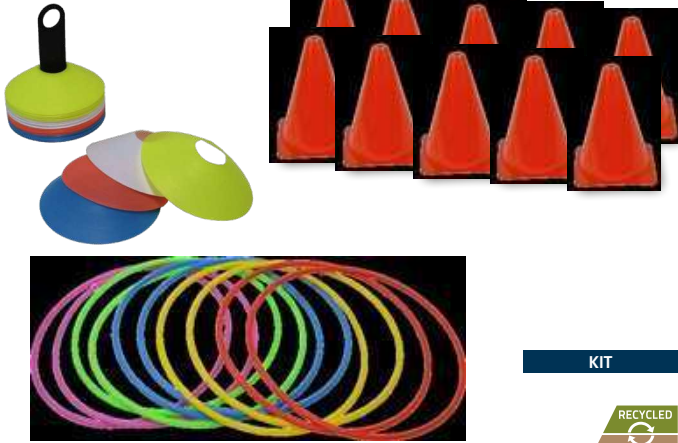

KIT



- 1 set of 40 markers cones
 - 1 set of 10 pcs of 65cm diameter round hoops
 - 1 set of 10 pcs of 23 cm high standard cones
- REFERENCE: 062999**

KIT F «LARGE MARKER CONES KIT»

SPORTi

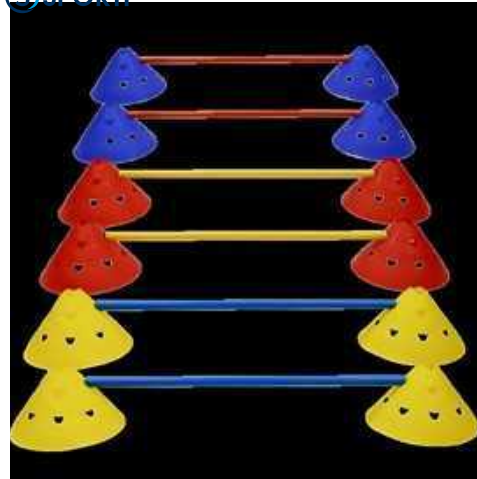

KIT



- 1 set of 12 big markers with notches multiple heights (5, 10 and 15 cm)
 - 6 poles (length 100 cm)
- REFERENCE: 062995**

KIT E «COMPLETE KIT»

SPORTi

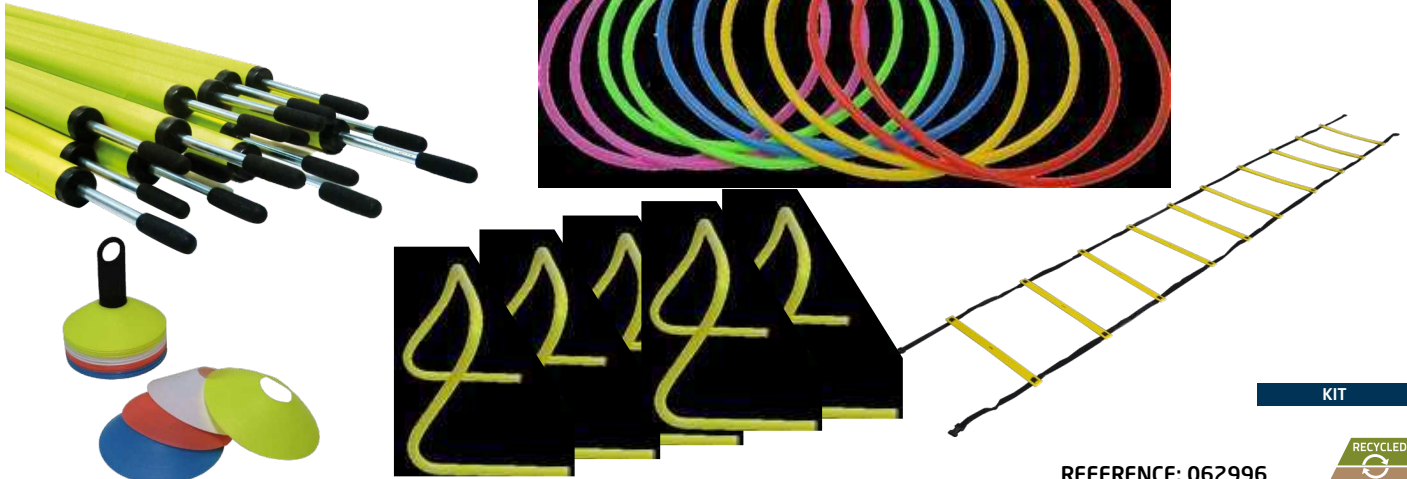

KIT



- 1 set of 40 markers cones
 - 1 set of 10 pcs of 65cm diameter round hoops
 - 1 set of 5 pcs of 30cm high speed hurdles
 - 1 set of 12 slalom poles with steel spike
- REFERENCE: 062996**

KIT D «SLALOM POLES»

SPORTi



+ Offered bag

KIT



- Set of 30 pcs of 160cm long slalom poles with steel spike, (15 red and 15 yellow)
 - 1 nylon bag (FREE)
- REFERENCE: 062997**

Sports bags, storage and transport
 Multisports
 Tracing and ground accessories
 Coach, referee and player
 First aid
 Fitness, bodybuilding and gym
 Swimming
 Combat sports
 Racket sports
 Athletics
 Balls
 School
 Nets and accessories

KIT H «MULTI-JUMPS 30-CM HIGH» PER UNIT



+ Matching colours

KIT



▪ 1 set of 2 30-cm high cones with 8 holes + 1 pole of 1 m. REF: 063324

KIT B «MULTI-JUMPS KIT 30-CM HIGH» PER 5

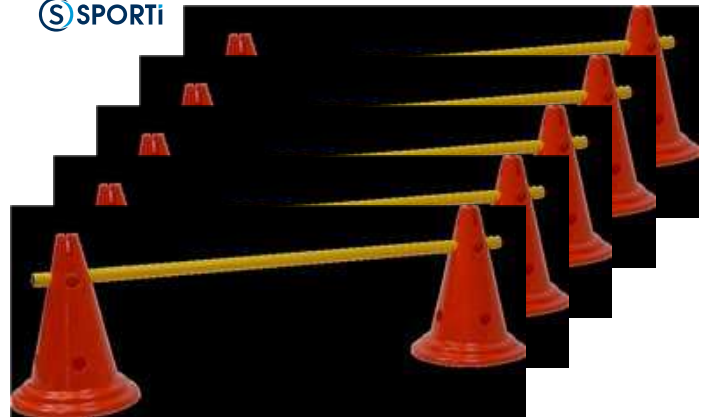

+ Matching colours

KIT



▪ 1 set of 10 30-cm high cones with 8 holes + 5 poles of 1 m. REF: 062998

KIT I «MULTI-JUMPS 50-CM HIGH» PER UNIT



+ Matching colours

KIT



▪ 1 set of 2 50-cm high cones with 12 holes + 1 pole of 1 m. REF: 063325

KIT C «MULTI-JUMPS KIT 50-CM HIGH» PER 5



+ Matching colours

KIT



▪ 1 set of 10 50-cm high cones with 12 holes + 5 poles of 1 m. REF: 063274

SPECIAL CONE WITH ONE STRIP



HEIGHT
24 cm

Square base of 14 cm stable and very visible, in polyethylene.

Reference: 063331

Unit

SET OF 10 NUMBERED SLEEVED-CONES



Set of 10 numbered cones with sleeves from 1 to 10. Suitable for the cones of 18, 20, 23 and 30 cm.

Reference: 099208

Set of 10

Sports bags, storage and transport
Multisports
Tracing and ground accessories
Coach, referee and player
First aid
Fitness, bodybuilding and gym
Swimming
Combat sports
Racket sports
Athletics
Balls
School
Nets and accessories



SIMPLE CONE



PVC standard cone with a square base for a greater stability. Available in 4 colours: Yellow / Red / Green / Blue.

Reference: 063332A 20 cm.
Reference: 063332B 30 cm.

EXTRA FLEXIBLE CONE



+ Unbreakable

HEIGHT 15 cm

Extra flexible cone with a round base, unbreakable, it folds up under the feet to avoid any risk of falling. Available in 6 different colours: Yellow / Red / Green / Orange / Purple / Blue.

Reference: 063013 15 cm.

MULTI-ACTIVITIES 30-CM HIGH / 8 HOLES



DIAMETER 25 cm
HEIGHT 30 cm

PVC cone with holes (8 holes) with 2-level special base for greater flexibility. Can receive all the poles with a standard diameter, notch for flat hoop. Available in 4 different colours: Yellow / Red / Green / Blue.

Reference: 063333 Unit

MULTI-ACTIVITIES 50-CM HIGH / 12 HOLES



DIAMETER 30 cm
HEIGHT 50 cm

PVC cone with holes (12 holes) with 2-level special base for greater flexibility. Can receive all the poles with a standard diameter, notch for flat hoop. Available in 4 different colours: Yellow / Red / Green / Blue.

Reference: 063334 Unit

STANDARD CONES



Polyethylene cone with square base. Available in 2 colours: Yellow / Red.

Reference: 063086 18 cm. Yellow / Red
Reference: 063086C 23 cm. Yellow / Red
Reference: 063086E 37 cm. Yellow / Red

FLEXIBLE RUBBER CONE



Polyethylene cone with wide round base, very stable. Available in 3 colours: Yellow / Red / Green.

Reference: 063330A 20 cm. 200 gr. Yellow / Red / Green
Reference: 063330B 35 cm. 700 gr. Yellow / Red / Green

HOOPS AND MARKERS

FLAT HOOP



Flat hoops allowing a greater stability to use on the floor. Available in 4 colours: red, green, yellow and blue.

Reference: 063027H	Unit	Ø40 cm.
Reference: 063027E	Unit	Ø50 cm.
Reference: 063027F	Unit	Ø60 cm.
Reference: 063027J	Unit	Ø70 cm.



FLAT-HOOP KIT

REFERENCE: 063309



- 10 flat hoops of 40 cm in diameter
- 10 flat hoops of 50 cm in diameter
- 10 flat hoops of 60 cm in diameter
- 1 hoop carrier

Reference: 063309 Kit
Reference: 063304 Hoop carrier only

ROUND HOOP

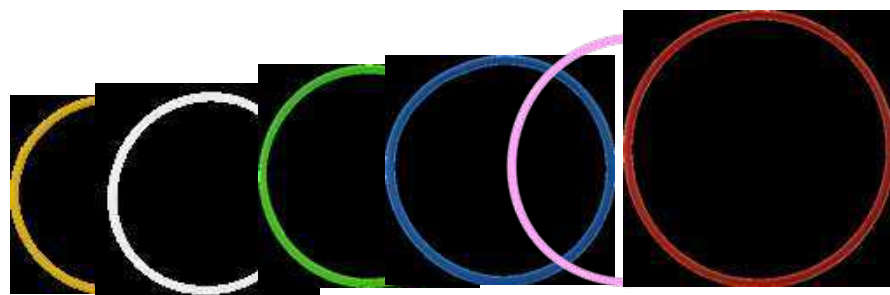

Available in 6 colours (white, red, green, yellow, pink and blue).

Reference: 063028	Unit	Ø50 cm.
Reference: 063028A	Unit	Ø65 cm.
Reference: 063028C	Unit	Ø75 cm.
Reference: 063028D	Unit	Ø85 cm.



SET OF 12 EXTRA-FLAT HOOPS

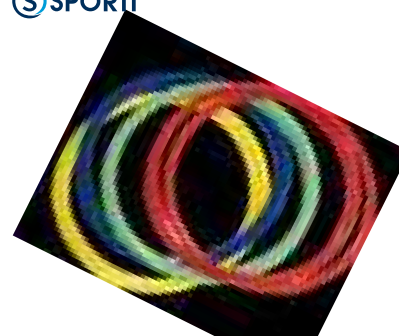

Extra flat and extra flexible hoops. They fold up as much as you want without losing their original shape. 3 hoops of each colour (blue, green, yellow and red).

Reference: 063026 Set of 12

LARGE MARKER CONES WITH NOTCHES

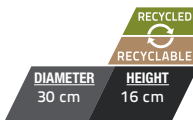

Delivered with a plastic support this set is composed of 12 markers cones of 3 different colours (red, yellow and blue). Markers cones with notches to fix mini hurdles with poles at different heights (5 - 10 - 15 cm).

Reference: 062994 Set of 12

LARGE MARKER CONES OF 15 CM HIGH



Markers cones with notches to fix mini hurdles with poles at a height of 15 cm. With a plastic support for the transport.

Reference: 063428 Set of 40

Sports bags, storage and transport
Multisports
Tracing and ground accessories
Coach, referee and player
First aid
Fitness, bodybuilding and gym
Swimming
Combat sports
Racket sports
Athletics
Balls
School
Nets and accessories

STANDARD MARKER CONES



SET OF 20



SET OF 40



SET OF 60

+ Marker cone holder for free for 20 markers bought by the unit



Standard marker (unit)

RECYCLABLE
DIAMETER 19 cm
HEIGHT 5.5 cm

Supplied with marker cone holder for the transport and the storage (composed of 4 colours white, blue, orange and yellow).

Reference: 063173	Set of 20
Reference: 063174	Set of 40
Reference: 063440	Set of 60
Reference: 063174U	Standard marker

EXTRA-FLEXIBLE MARKER CONES WITHOUT NOTCH



+ Extra flexible



RECYCLABLE
DIAMETER 19.5 cm
HEIGHT 3.5 cm

Extra-flexible marker cones, they fold up under the feet to avoid any risk of falling. Anti-UV treatment. Supplied with a holder for the transport.

Reference: 063429	Set of 20	White
Reference: 063340	Set of 20	Blue/White/Orange/Yellow
Reference: 063430	Set of 40	White
Reference: 063404	Set of 40	Blue/White/Orange/Yellow

EXTRA-FLEXIBLE MARKERS CONES WITH NOTCHES



+ Extra flexible



RECYCLABLE
DIAMETER 19.5 cm
HEIGHT 5 cm

Extra-flexible markers cones with notches allowing to fix poles at a height of 5cm to have mini hurdles. They fold up under the feet to avoid any risk of falling. Supplied with a support for the transport.

Reference: 063431	Set of 20	White
Reference: 063405	Set of 20	Yellow / Red
Reference: 063407	Set of 20	Yellow / Red / White / Blue
Reference: 063432	Set of 40	White
Reference: 063406	Set of 40	Yellow / Red
Reference: 063345	Set of 40	Yellow / Red / White / Blue

MARKING DISCS



+ It does not deflect the ball



RECYCLABLE
DIAMETER 15.5 cm

Set of 24 marking discs non-skid, perfectly adapted to indoor trainings or on synthetic floor. Robust metal support designed to easily remove or put the discs back.

Reference: 063303	Set (12 yellow and 12 orange)
Reference: 063480	Set (8 blue, 8 white and 8 red)

WHITE MARKING DISCS



RECYCLABLE
DIAMETER 20.5 cm

Set of 20 white marking discs, non-skid, perfectly adapted to indoor trainings or on synthetic floor. Real asset for training as it does not deflect the ball. Robust metal support designed to easily remove or put the discs back.

Reference: 063433	Set of 20
-------------------	-----------

SET OF 20 EXTRA SOFT MARKING RINGS



+ Extra flat



+ Delivered with a mesh carry bag

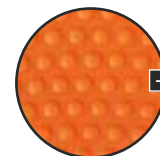

+ Non-skid bottom

RECYCLABLE
DIAMETER 19 cm

Set composed of 5 neon pink/ 5 turquoise/5 neon yellow/ 5 neon orange. Non-skid material, perfectly adapted to indoor trainings or on synthetic pitch. Its strengths are that they do not deflect the trajectory of the ball and that the hole in the middle allows to hold a ball in order to imagine any kind of game. Delivered in a mesh carry bag. 8 cm hole Ø.

Reference: 063119	Set of 20
-------------------	-----------

ADHESIVE FLOOR MARKING TAPE



+ Doesn't leave traces of glue

LENGTH 45 m WIDTH 5 cm

Adhesive tape for temporary floor marking. Good resistance to abrasion. Does not leave traces of glue on the floor after use. Easy installation due to its hand-breakable canvas structure.

Reference: 064505 Unit

LAND MARKING KIT



x15

The kit includes a reel, a 50 m elastic band and 15 stakes. It will be very useful for delimiting any type of playing area (tennis ball court, ball conserving area, etc.). Very easy to use, this 3cm wide «buttonhole» elastic is clearly visible and has woven holes to facilitate the use of the pegs. Its stretched length can reach 100 m.

Reference: 099045 Kit
Reference: 099044 Provided with 15 stakes

GROUND MARKERS WITH NUMBERS



+ Flexible and non-skid

DIAMETER 20.5 cm THICKNESS 3 mm

Ground markers with numbers from 1 to 10. Non-skid flexible rubber and robust with a grainy appearance on one side.

Reference: 062981 Set of 10

FLOOR MARKING TAPE



2.5 M 10 M 20 M

RECYCLABLE WIDTH 4 cm

Available in 3 lengths: 2.5 m, 10 m and 20 m. 4 different colours: Blue, Red, Green and Yellow.

Reference: 069109 2.5 m
Reference: 069057 10 m
Reference: 069058 20 m

SET OF FLOOR MARKING



KIT

Set of 20 red slats (ref: 069103) and 4 yellow corners (ref: 069101).

Reference: 069224 Set

KIT G: ROUND MARKERS KIT

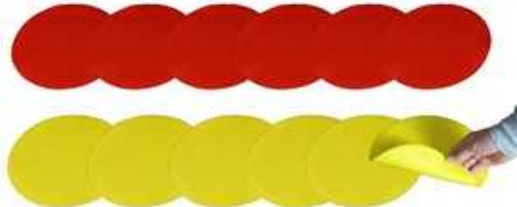

+ Flexible and non-skid

KIT DIAMETER 25 cm THICKNESS 3 mm

Kit composed of 12 round markers (6 red + 6 yellow).

Reference: 062992 Kit

SQUARE MARKER

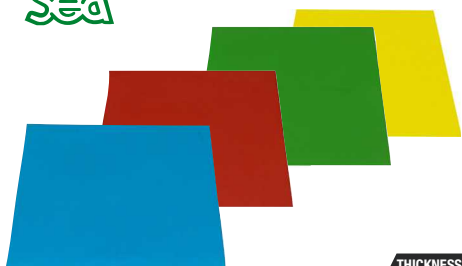

THICKNESS 3 mm

Non-skid soft-rubber marker with 1 structured side. Available in 4 colours: Blue, Red, Green and Yellow.

Reference: 069104 20 x 20 cm.

ROUND MARKER

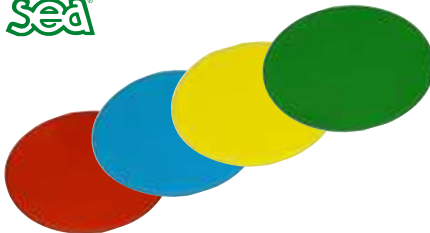

DIAMETER 25 cm THICKNESS 3 mm

Non-skid soft-rubber marker with 1 structured side. Available in 4 colours: Blue, Red, Green and Yellow.

Reference: 069100 Unit

CORNER MARKER



SIDES 27 cm WIDTH 7 cm THICKNESS 3 mm

Non-skid soft-rubber marker with 1 structured side. Available in 4 colours: Blue, Red, Green and Yellow.

Reference: 069101 Unit

FLOOR MARKING SLAT

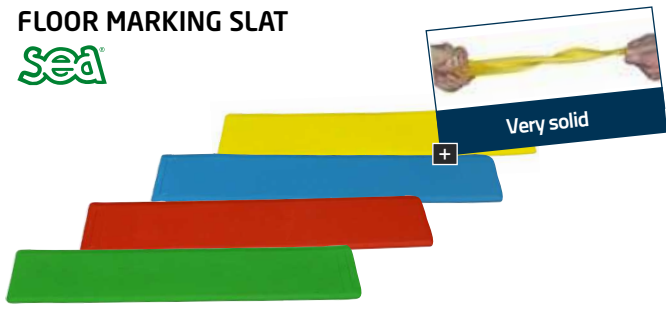

WIDTH	LENGTH	THICKNESS
7.5 mm	35 cm	3 mm

Non-skid soft-rubber marker with 1 structured side. Available in 4 colours: Blue, Red, Green and Yellow.

Reference: 069103 Unit

TRIANGLE MARKER



SIDE	THICKNESS
20 cm	3 mm

Non-skid soft-rubber marker with 1 structured side. Available in 4 colours: Blue, Red, Yellow and Green.

Reference: 069108 Unit

VINYL HAND MARKER



THICKNESS
3 mm

Non-skid soft-rubber marker with 1 structured side. Available in 4 colours: Blue, Red, Green and Yellow.

Reference: 069105 Pair

CASE FOR MOTOR



KIT

Large case containing 32 vinyl pieces in 4 different colours (4 pairs of feet, 4 pairs of hands, 4 triangles, 4 circles and 8 arrows). To understand the notions of balance, of shapes and colours.

Reference: 069215 Unit
Reference: 024070 Single case

VINYL SLAT



RECYCLABLE

Delivered in 4 matching colours.

Reference: 069051U Slat 40 cm L. x 4 cm w.
Reference: 069221 Set of 20 slat - 40 cm L. x 4 cm w.
Reference: 069222 Set of 40 slat - 40 cm L. x 4 cm w.

ARROW MARKER

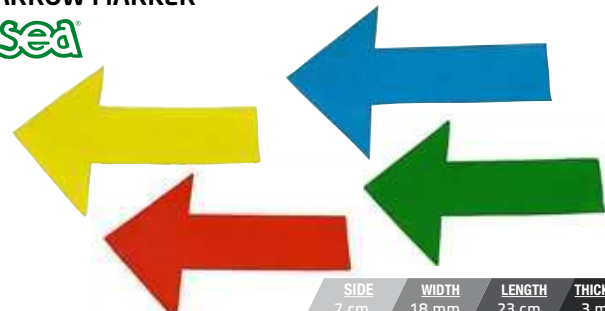

SIDE	WIDTH	LENGTH	THICKNESS
7 cm	18 mm	23 cm	3 mm

Non-skid soft-rubber marker with 1 structured side. Available in 4 colours: Blue, Red, Green and Yellow.

Reference: 069102 Unit

VINYL FOOT MARKER



LENGTH	THICKNESS
23 cm	3 mm

Non-skid soft-rubber marker with 1 structured side. Available in 4 colours: Blue, Red, Green and Yellow.

Reference: 069106 Pair

CASE FOR PSYCHOLOGICAL COURSE

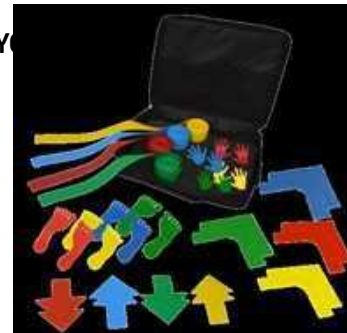

KIT

RECYCLABLE

Large case containing 36 vinyl pieces in 4 different colours (4 pairs of feet, 4 pairs of hands, 4 floor marking tapes, 8 corner markers and 8 arrows). Ideal in terms of placement or teaching resource for setting out play routes by mixing feet, hands, and various shapes and colours.

Reference: 069214 Unit
Reference: 024070 Single case

Sports bags, storage and transport
Multisports
Tracing and ground accessories
Coach, referee and player
First-aid
Fitness, bodybuilding and gym
Swimming
Combat sports
Racket sports
Athletics
Balls
School
Nets and accessories

SIMPLE SPEED LADDER 2 M

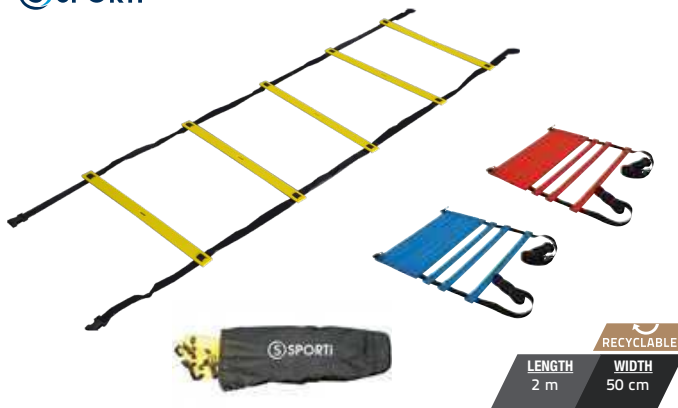

RECYCLABLE	
LENGTH	WIDTH
2 m	50 cm

Made with 2 nylon straps and 5 flat bars for safety reasons, it is the perfect tool to work the coordination. Supplied with a carrying bag.

- Reference: 063180A Unit - Yellow
- Reference: 063180A Unit - Blue
- Reference: 063180A Unit - Red

SIMPLE SPEED LADDER 4 M

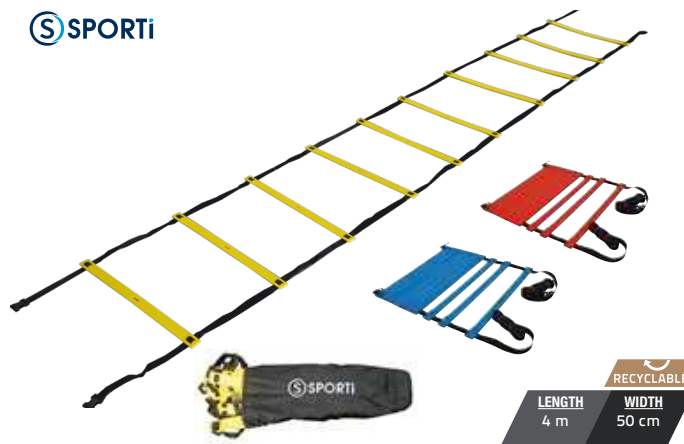

RECYCLABLE	
LENGTH	WIDTH
4 m	50 cm

Made with 2 nylon straps and 10 flat bars for safety reasons, it is the perfect tool to work the coordination. Supplied with a carrying bag.

- Reference: 063177A Unit - Yellow
- Reference: 063177A Unit - Blue
- Reference: 063177A Unit - Red

DOUBLE SPEED LADDER

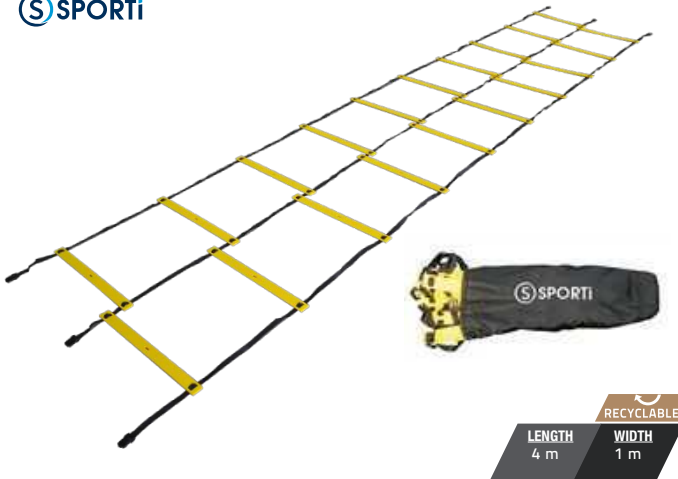

RECYCLABLE	
LENGTH	WIDTH
4 m	1 m

Same composition as the simple speed ladder, the double speed ladder allows to work in a different way in particular due to a longer distance between the bars. Supplied with a carrying bag.

- Reference: 063178 Unit

SET OF 12 OCTAGONAL HOOPS



RECYCLABLE	
OUTSIDE Ø	
49 cm	

Set of 12 octagonal hoops with 10 joint clips. Colour: Neon yellow. Supplied with a carry bag. Outside Ø 49 cm.

- Reference: 063456 Set

SPEED LADDER FOR CROSS POSITIONING

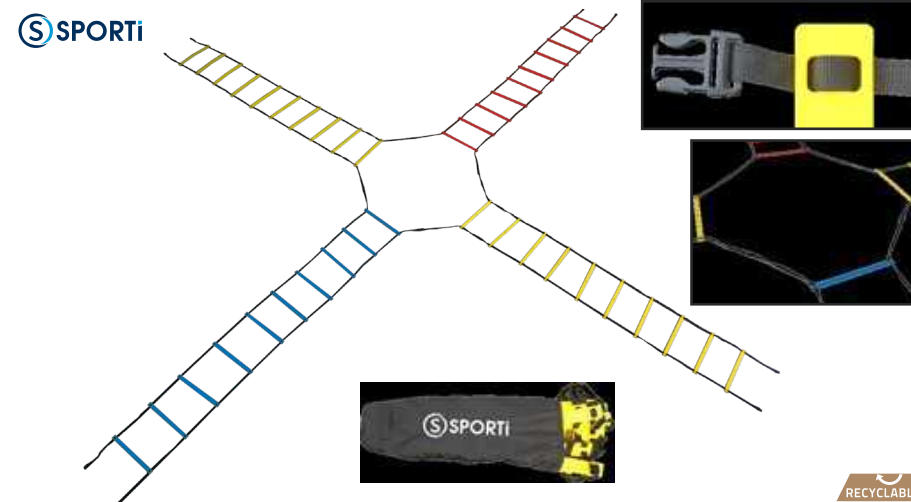

RECYCLABLE	
------------	--

Set of 4 simple speed ladders (2 Yellow, 1 Blue, 1 Red 063177A) allowing to form a «cross» (~ 10 x 10 m) in order to vary the motor activities. Supplied with a carrying bag. To assemble yourself.

- Reference: 063451 Unit

SET OF 10 TRAINING SLATS



RECYCLED	
RECYCLABLE	

LENGTH	WIDTH	HEIGHT
50 cm	4 cm	0.5 cm

Set of 10 slats in white PVC.

- Reference: 025008

SLALOM POLE WITH PLASTIC SPIKE 160 CM

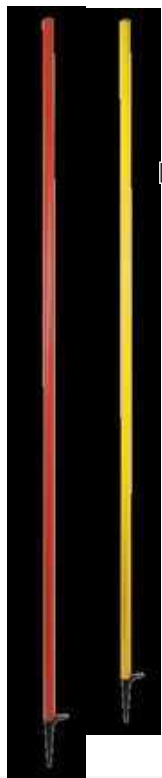

+ Diameter 25 mm



DIAMETER 25 mm HEIGHT 160 cm

Slalom pole with plastic spike. Available in yellow and red.

Reference: 063349 Unit

SLALOM POLE 25 MM



+ Diameter 25 mm



RECYCLED RECYCLABLE DIAMETER 25 mm HEIGHT 160 cm

PVC pole with steel spike. Available in yellow, blue, red and white.

Reference: 063130 Unit

SLALOM POLE 32 MM

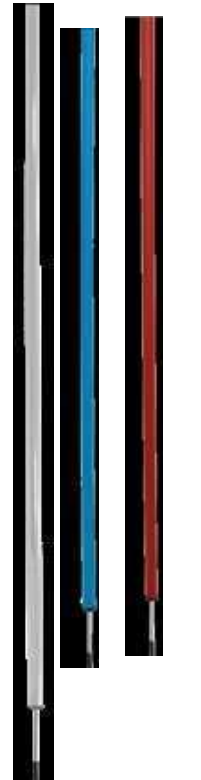

+ Diameter 32 mm



RECYCLED RECYCLABLE DIAMETER 32 mm HEIGHT 170 cm

PVC pole with steel spike. Available in yellow, blue, red and white.

Reference: 063129 Unit

SLALOM POLE 160 CM FOR SYNTHETIC PITCH

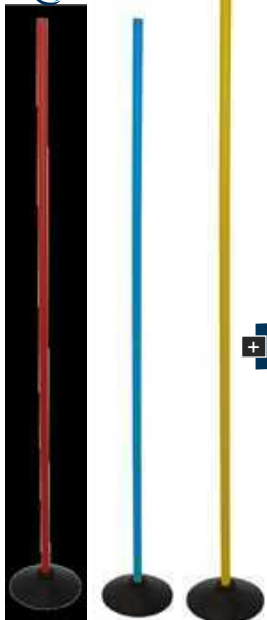

+ Suitable for indoors

DIAMETER 25 mm HEIGHT 160 cm

This slalom pole is composed of a solid rubber base of 22 cm + pole. Available in yellow, blue or red.

Reference: 063312 Unit - Yellow

Reference: 063313 Unit - Blue

Reference: 063314 Unit - Red

FLEXIBLE SLALOM POLE

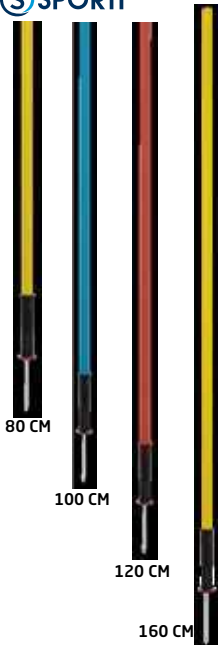

Single tip available individually



DIAMETER 25 mm

Flexible slalom pole to the base. Available in 3 colours (yellow, red and blue) and 4 sizes (80, 100, 120 and 160cm). Single tip to assemble yourself on the stake.

Reference: (Unit)

063319 80 cm

063319 100 cm

063319 120 cm

063319 160 cm

063427 Single tip

BAG FOR SLALOM POLES / POLES

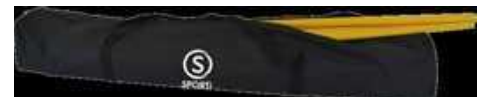

+ Up to 50 slalom poles / poles

LENGTH 185 cm WIDTH 25 cm HEIGHT 25 cm

Reinforced nylon bag. Zip fastening. Due to its handles, this bag allows to easily transport up to 50 slalom poles.

Reference: 078063 Unit

Multisports

Tracing and ground accessories

Coach, referee and player

First-aid

Fitness, bodybuilding and gym

Swimming

Combat sports

Racket sports

Athletics

Balls

School

Nets and accessories

POLES AND BASES

PLASTIC POLE WITH CAPS



WOODEN STICK

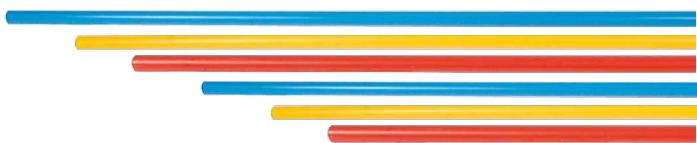

RECYCLABLE
DIAMETER
25 mm

Plastic pole with black caps at each end. Available in 3 different colours: Yellow / Red / Blue.

Reference: 063022H	L: 80 cm.
Reference: 063022M	L: 100 cm.
Reference: 063022J	L: 120 cm.
Reference: 063022C	L: 140 cm.
Reference: 063022K	L: 160 cm.
Reference: 063022D	L: 180 cm.

Turned and polished wooden stick. Used for indoor warm-up.

Reference: 033115A	L: 80 cm.	Unit
Reference: 033115B	L: 100 cm.	Unit
Reference: 033115C	L: 120 cm.	Unit
Reference: 033115E	L: 140 cm.	Unit

RIGID BASE IN PVC



RUBBER BASE



RUBBER BASE 3 HOLES



RECYCLED
RECYCLABLE
DIAMETER 22 cm WEIGHT 220 g HEIGHT 11 cm

RECYCLABLE
DIAMETER 22 cm WEIGHT 1.25 kg

RECYCLABLE
DIAMETER 23 cm WEIGHT 1.25 kg

PVC fillable rigid base. Yellow. For poles: 25 mm Ø.

Reference: 063396

Solid rubber base. For poles: 25 mm Ø.

Reference: 063172

3-holes rubber base to fix a max of 3 poles or to build V-shaped slalom obstacles or courses. Suitable for poles 25 mm diam.

Reference: 063346

FILLABLE BASE



MULTI FUNCTION BASE



FLEXIBLE BASE IN PVC

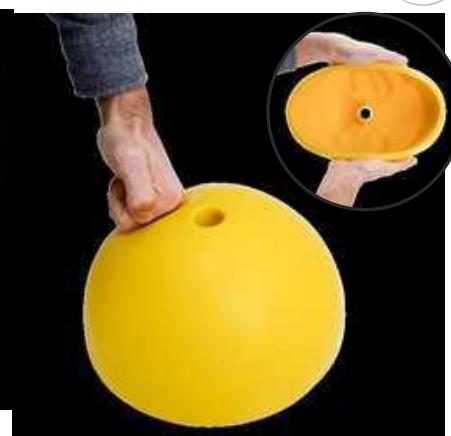
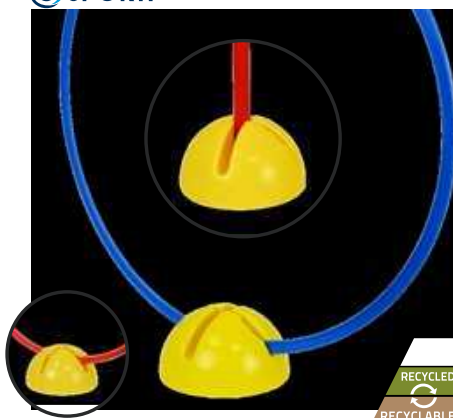

RECYCLABLE
DIAMETER 24 cm WEIGHT 360 g HEIGHT 12 cm

RECYCLED
RECYCLABLE
DIAMETER 20 cm WEIGHT 350 g HEIGHT 11 cm

DIAMETER 24 cm WEIGHT 850 g HEIGHT 12 cm

Fillable base with sand, it insures a perfect stability during the exercises. Yellow colour.

Reference: 063348 For tube 32 mm Ø

Multi-function base for 25 mm-diam poles, as well as flat or round hoops. Yellow.

Reference: 063170

Flexible base in PVC. For pole of 25 mm Ø.

Reference: 063075

PASSING ARC

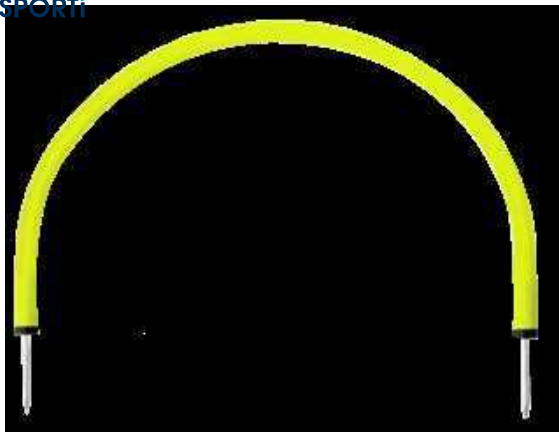

RECYCLABLE
LENGTH 50 cm
HEIGHT 40 cm

High-quality passing arc with steel spikes.

Reference: 063247 Unit

PASSING ARC FOR SYNTHETIC FLOOR AND INDOOR USE



Arch		Bases	
H.	40 cm	Ø	22 cm
L.	55 cm	W.	1.25 Kg

RECYCLABLE

PVC high-quality passing arch for synthetic grounds and sand. Composed of one arch and two solid rubber bases.

Reference: 063323 Kit
Reference: 063322 Precision arch (Unit)

TRAINING KIT WITH FILLABLE BASES

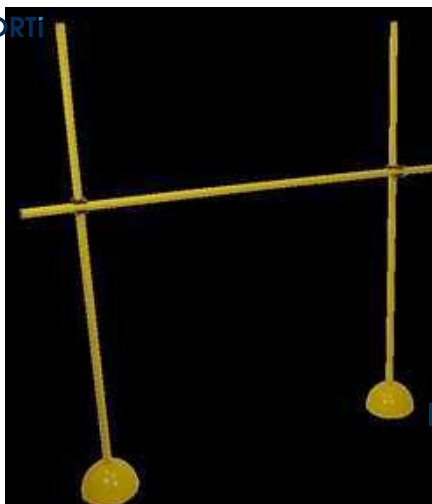

KIT

RECYCLED
RECYCLABLE

Contains 2 fillable bases, 3 poles of 1.60m length. 2 attachment clips allowing to unite the kit.

Reference: 062723 Unit

TRAINING KIT WEIGHTED

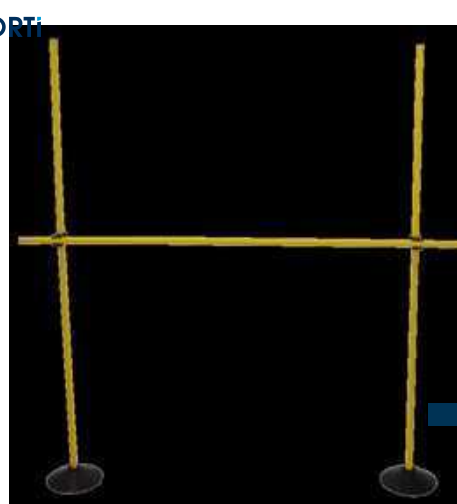

KIT

RECYCLED
RECYCLABLE

This kit contains: 2 black weighted flat bases, 3 poles of 1.60 m length. 2 attachment clips allowing to unite the kit.

Reference: 062722 Unit

CLIPS



RECYCLED
RECYCLABLE

Rotating multi-use clip allows to hold tubes and hoops between them (example: show jumping, used with the hoops to create targets, etc.).
A/ Set of 12 in 4 colours: Yellow / Red / Green / Blue.

Reference: 064424 Rotating multi-use clips A/ Set of 12
Reference: 063131 Black multi-use clips B/ Unit

FIXING STRIPS WITH HOOK AND LOOP FASTENER



It allows to fix a hoop on a handball or football goal in order to develop the precision.

Reference: 062719 Pair

HURDLES

FLEXIBLE HURDLE



+ If it is pressed underfoot it will automatically straighten up

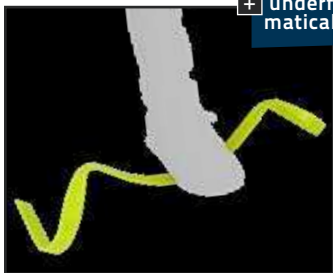

Flexible PVC hurdle to avoid any danger. It automatically gets its original position back if someone steps on.



Reference: 063184	Wid. 46 cm.	Hei. 15 cm.	Turquoise
Reference: 063185	Wid. 46 cm.	Hei. 23 cm.	Yellow
Reference: 063186	Wid. 46 cm.	Hei. 30 cm.	Orange

SPEED HURDLE

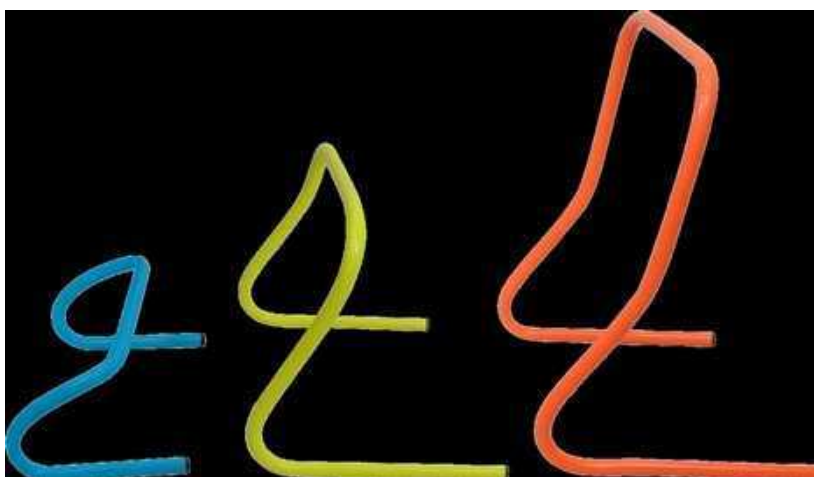

Hurdle in reinforced PVC. Practical and easy to transport and store.



Reference: 063183A	Wid. 47 cm.	Hei. 15 cm.	Turquoise
Reference: 063183B	Wid. 47 cm.	Hei. 30 cm.	Yellow
Reference: 063183C	Wid. 47 cm.	Hei. 45 cm.	Orange

BOUNCE-BACK HURDLE



+ They automatically straighten up

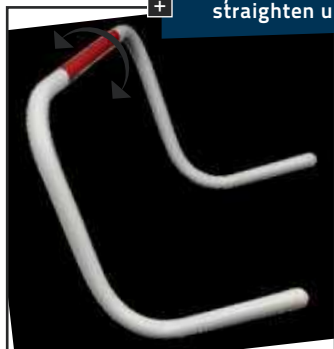

Very useful, these hurdles automatically straighten up.

Reference: 063302A	Wid. 70 cm	Hei. 21 cm.	White/Blue
Reference: 063302B	Wid. 70 cm	Hei. 26 cm.	White/Yellow
Reference: 063302C	Wid. 70 cm	Hei. 31 cm.	White/Blue
Reference: 063302D	Wid. 70 cm	Hei. 36 cm.	White/Red
Reference: 063302E	Wid. 70 cm	Hei. 50 cm.	White/Blue

Sports bags, storage and transport
Multisports
Tracing and ground accessories
Coach, referee and player
First aid
Fitness, bodybuilding and gym
Swimming
Combat sports
Racket sports
Athletics
Balls
School
Nets and accessories

HURDLES

SPEED HURDLE



Available in kit
6 hurdles / 3 heights

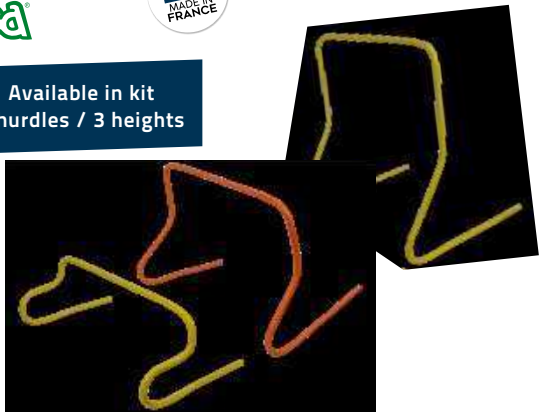

Speed hurdles in elastomeric material, very flexible, light and easily transportable.

- Reference: 025013B Ø: 16 mm - 60 cm L. - 20 cm H.
- Reference: 025013C Ø: 16 mm - 60 cm L. - 40 cm H.
- Reference: 025013D Ø: 16 mm - 60cm L. - 60 cm H.
- Reference: 025013A KIT: 2x20 cm + 2x40cm + 2x60cm

ADJUSTABLE INITIATION HURDLE



Hurdle in PVC tube with an adjustment system of the height. Width 100 cm.

- Reference: 063386 Little model - Red Adjustable from 35 to 60 cm
- Reference: 063393 Large model - Blue Adjustable from 60 to 105 cm

TRAINING HURDLE 4 HEIGHTS



Perfect to prepare diversified motor ability sessions, these training hurdles adjustable on 3 heights (15 cm, 23 cm and 29 cm) allow to offer different exercises according to age and the desired level of difficulty. Easily transportable and foldable. Designed for both indoor and outdoor use.

Reference: 025032

Unit

SPEED HURDLES KIT



KIT

This kit contains: 4 speed hurdles of 15 cm, 4 speed hurdles of 30 cm, 4 speed hurdles of 45 cm and one hurdles carrier.

Reference: 063308

Kit

Reference: 063304

Single hurdle carrier

TCHOUKBALLS

TCHOUKBALL

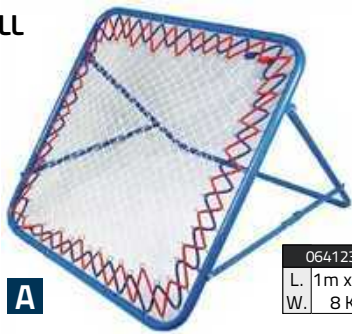

064123R
L. 1m x 1m
W. 8 Kg

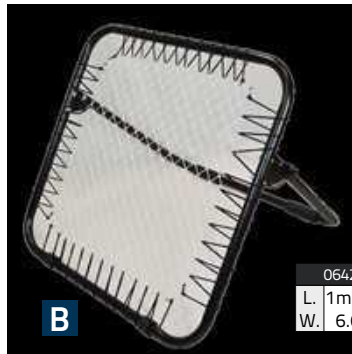

064226
L. 1m x 1m
W. 6.6 Kg



Inclination: 0 to 90°

A Frame of 32 mm in blue painted steel with a nylon net fixed by straps. Adapted to the practice from a very early age and learning at initial rebounds.
B Light frame of 40 mm in light steel, black colour. Adjustable inclination allowing to learn initial rebounds on all angles.

Reference: 064123R

Reference: 064123F

Reference: 064226

A

A Spare net

B



DOUBLE TCHOUKBALL

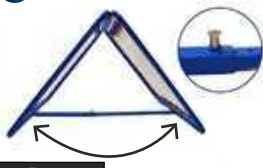

Frame
L. 1 m
W. 1 m

Adjustable from 50 to 70°

RECYCLABLE
WEIGHT
11.3 kg

Double Tchoukball with adjustable bar allowing to modify inclination (18 positions) and thus vary exercises (short game and long game). Perfect for technical and precision work, especially for goalkeepers and from a very early age. Blue steel frame of 32 mm with net fixed by 2 straps on removable hooks.

Reference: 064125

Unit

TCHOUKBALL 4 SIDES

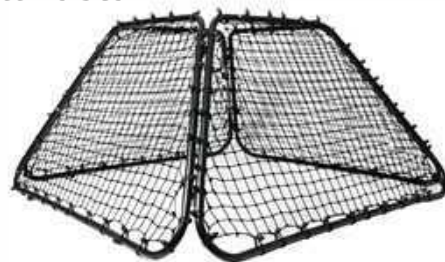
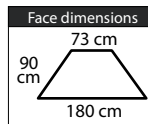

Tchoukball 4 sides allows to work some people at the same time. You can use it for team sports and individual sports... Perfect for technical work, physical, repeated and precision in particular for goalkeepers, from the youngest age. Easy to set up and to store. Black steel frame of 32 mm with polyethylene net and fixed by straps.

Reference: 064121

Unit

MINI TCHOUKBALL 76CM



Frame
L. 76 cm
W. 76 cm

RECYCLABLE
WEIGHT
7 kg

32mm section frame, blue painted steel with a nylon net fixed by elastic straps. Adapted to practice from an early age and first rebounds learning.

Reference: 064045

Unit

HAND TCHOUKBALL



Frame
L. 60 cm
W. 60 cm

WEIGHT
2 kg

Hand Tchoukball with rebound net to work reflexes especially during goalkeepers' training. Black steel frame of 25 mm with handles, dimensions 60 x 60 cm. Net fixed with strap on removable hooks.

Reference: 064124

Unit

TCHOUKBALL SET

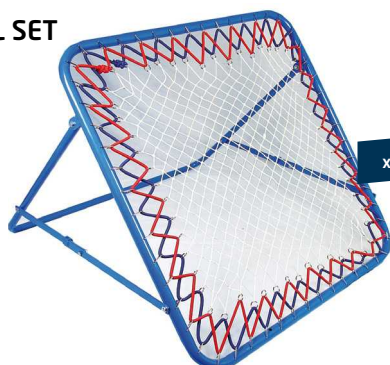

x2



x2



x6



x6

KIT

This set is composed of:
- 2 Tchoukballs / ref: 064123R -2 progressive handballs size 1 / ref: 067310
-12 training bibs M Size / ref: 063209 (2 different matching colours)

Reference: 064153

Kit



TRAINING HARNESS



+ Reinforced product

STRAP LENGTH 3.20 m

This training harness is perfect to work the muscle-strengthening. Widely used in sports that require accelerations and sprints of short distances. It has a foam handle very ergonomic for the person who exerts a force against the sportsman movement, a harness very comfortable held to the shoulder level to avoid any risk of injury.

Reference: 062735 Unit

EVASION TAG RUGBY BELT



RECYCLED RECYCLABLE

Set of 2 adjustable belts for players of all sizes connected by a strap. By anticipating your opponent's movements, this device will help you improve your agility and escaping skills.

Reference: 062777 Unit

POWER SPEED

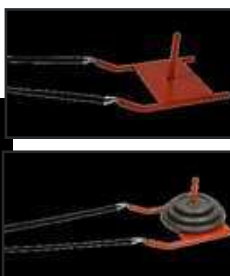

RECYCLABLE LENGTH 55 cm WIDTH 37 cm

Power Speed is recommended for resistance exercises in order to develop explosivity and running speed. It is also highly effective to improve the starting speed. Adapted for all sizes thanks to its adjustable belt, this tool is playful and user-friendly. Initial weight: 3.5 kg. Possibility to add some weights until 60 kg.

Reference: 060063 Unit
 Reference: 060063S The strap alone + harness
 Reference: 062758 Training weight 5 kg.
 Reference: 062759 Training weight 10 kg.
 Reference: 062760 Training weight 20 kg.

PARACHUTE



Training parachute in durable nylon with belt. It allows to work speed and power.

Reference: 060077 Unit

INFLATABLE MEDICINE BALL



Low rebound +

RECYCLABLE

Inflatable medicine ball. Great grip thanks to its rough rubber coating. It will allow you to perform carefully all your bodybuilding and training exercises.

Reference: 021021 1 kg. / Yellow 18 cm. Ø
 Reference: 021022 2 kg. / Green 19 cm. Ø
 Reference: 021023 3 kg. / Red 22.6 cm. Ø
 Reference: 021024 4 kg. / Blue 22.6 cm. Ø
 Reference: 021025 5 kg. / orange 23 cm. Ø

DUMMY 180CM



Metal structure

WITH PROTECTIVE

Delivered with protective connectors

AVAILABLE IN SET OF 3

RECYCLABLE
WIDTH 50 cm HEIGHT 180 cm



It is composed of a metal structure equipped of springs allowing it to fold without break and of a plastic breastplate. It can be fixed to the ground thanks to 4 metal points. It can be used on synthetic pitch thanks to its rubber base (not provided, ref 063454).

SINGLE DUMMY

- Reference: 063452 ● Single yellow dummy
- Reference: 063475 ● Single red dummy

KIT OF 3 DUMMIES

- Reference: 063471 ● Set of 3 yellow dummies
- Reference: 063483 ● Set of 3 red dummies

DUMMY + BASE

- Reference: 063455 ● Yellow dummy + base
- Reference: 063484 ● Red dummy + base

WEIGHTED RUBBER BASE FOR DUMMIES



Base
W. 12 Kg

RECYCLABLE
LENGTH 48 cm WIDTH 32 cm HEIGHT 11.5 cm

Weighted rubber base. It allows to hold dummies in place on smooth or synthetic surfaces. Compatible with many dummies models.

Reference: 063454

Single base

TWO-IN-ONE WEIGHTED BASE FOR GOALS AND DUMMIES

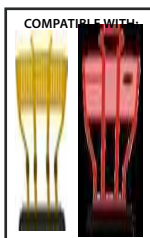

Base
W. 12 Kg
For tube
Ø max : 40mm

RECYCLABLE
LENGTH 50 cm WIDTH 32 cm HEIGHT 11.2 cm

Claws on one base side allowing to weight mini goals and thus avoid their toppling. It is made in such a way that claws are put on the bar which is behind mini goals. It is compatible with all mini goals with tube diameter until 40mm. One base is enough for a mini goal. It also allows to hold dummies in place on smooth or synthetic surfaces due to all holes which are on the top of the base. Colour: Black.

Reference: 063344

Unit

• DUMMY FOOTBALL PRO 180 CM

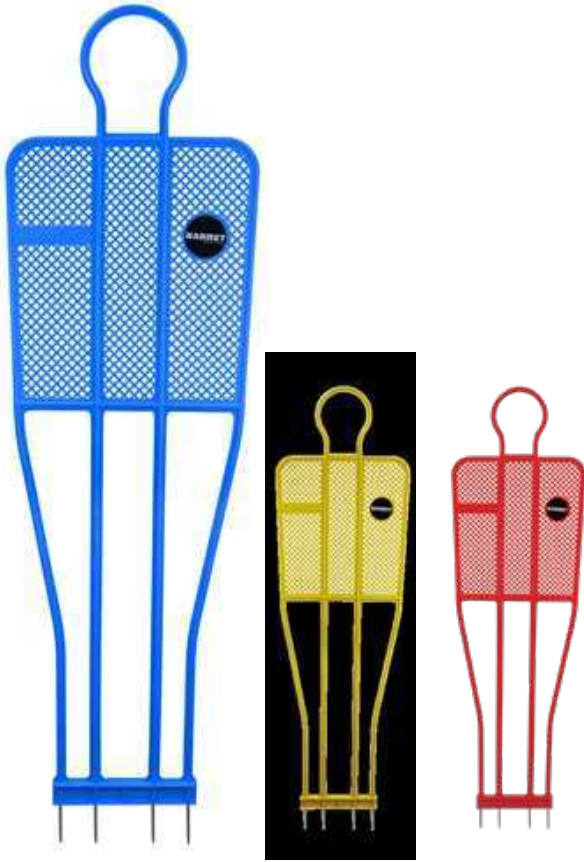

RECYCLABLE

BARRET patent (official supplier of a lot of professional clubs). Very flexible, it folds up but never breaks. 4 steel points for a greater stability. Available in red, yellow and blue.

Reference: 062717A 180 cm

FLEXIBLE DUMMY

SPORTI



Carrying bag for set of 3 dummies



Sold in sets of 3 + flexible slalom poles + carry bag



OR



Available in single flexible dummy

Flexible dummy delivered in its carrying bag. Sold as a kit with flexible slalom poles for grass ground or sand or with poles + bases for synthetic and hard grounds.

Reference: 063479 Set of 3 dummies + flexible slalom poles + carrying bag
Reference: 063478 Single flexible dummy

DUMMIES TROLLEY

SPORTI



RECYCLED RECYCLABLE

Dummies trolley, which can take the dummies ref 062717A, 063452 and 063475. Easy to assemble, very robust and manoeuvrable it will make your free kick sessions easier.

Reference: 062715 Unit

JUNIOR DUMMY 106 CM

SPORTI



WIDTH 33 cm

With its structure and its resistant and flexible plastic breastplate, this dummy will allow you to practice dribbling and free kicks with the youngest. With 2 steel spikes for planting in the ground (not compatible with bases 063454 and 063344)

Reference: 063481 Unit



Sports bags, storage and transport
Multisports
Tracing and ground accessories
Coach, referee and player
First-aid
Fitness, bodybuilding and gym
Swimming
Combat sports
Racket sports
Athletics
Balls
School
Nets and accessories

• INFLATABLE DUMMY



Automatically straightened up



FRONT

BACK

Full tank	Empty tank
W. 15 Kg	W. 2.15 Kg

HEIGHT 185 cm

PVC inflatable training dummy, flexible and robust with carry handles. Perfect to work game situations in handball, football without injure yourself.

Reference: 063435 Unit

INFLATABLE DUMMIES



2 dimensions: 180 and 205 cm

Automatically straightened up



Inflation valve



Hole for water ballast



This dummy will allow you to work on the «aerial game» of your goalkeepers in complete safety. Once the base is filled with water or sand and the top is inflated, this spike-resistant dummy will remain stable and secure.

Reference: 063476 180 cm

Reference: 063477 205 cm

HANDBALL/BASKETBALL INFLATABLE DUMMY



Rights itself automatically



WIDTH 60 cm HEIGHT 240 cm

PVC inflatable dummy, width of 60 cm and height of 240 cm (to the top of the hand). Ideal for setting up different training sessions in handball and basketball. Once the base is filled with water and the upper part is inflated, it offers excellent stability and safe use. Easy to move thanks to side handles, it automatically rights itself after impact.

Reference: 063499 Unit

RUGBY INFLATABLE DUMMY



Rights itself automatically

Height of 125 cm suitable for introducing children to tackling



WIDTH 35 cm HEIGHT 125 cm

Thanks to its height of 125 cm, this contact dummy is perfectly suited for initiating kids to rugby. It has been especially designed to tackling at waist level in a fun and educational way, in complete safety. Once the base is filled with water and the upper part is inflated, it offers excellent stability. Automatically rights itself after impact.

Reference: 063498 Unit

TARGET FOR FOOTBALL GOAL

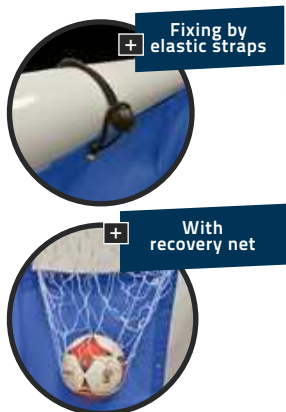

3 dimensions +

Goal 5 x 2m
L. 500 cm
H. 200 cm

Goal for 8
L. 600 cm
H. 210 cm

Goal for 11
L. 732 cm
H. 244 cm

8 or 11-a-side nylon football target goal for precision work. It has 5 numbered targets (dimensions: 1 x 0.6 m) with a net behind each target to make the ball recovery easier. Fixing by elastic straps.

Reference: 064122 Target for goal 5 x 2m - 22 straps provided
 Reference: 064110 Target for goal for 8 - 26 straps provided
 Reference: 064107 Target for goal for 11 - 30 straps provided

TARGET WITH WEIGHTED BASE



Available in 2 sizes +

Supplied with a carrying bag +

FOOTBALL for 8
FOOTBALL for 11



600 deniers polyester net. Ballast included to keep the net straight and taut. Quick fixing on the crossbar and posts due to its hook and loop fasteners.

Reference: 064022 For goal FOOTBALL for 8
 Reference: 064023 For goal FOOTBALL for 11

TARGET FOR FOOTBALL GOAL



3 hook and loop fasteners + Easy assembly and adjustment +



Adjustable height = fits on goal at 8 and 11

Target	Support
L. 60 cm	L. 74 cm
w. 60 cm	w. 74 cm

Delivered with 2 pegs

Supplied with a carrying bag

Made in coating polyester tarpaulin very resistant and easy to install due to its hook and loop system, this set of 4 adjustable targets (2 x 2) can be set up on football goals for 8 (6 x 2.1 m) or for 11 (7.32 x 2.44 m) due to adjustables straps. It can be your ideal partner for your penalty sessions. Colour: blue. Delivered with its carry bag. Can be installed on grass and on synthetic.

Reference: 064106 Pair = 4 targets

Sports bags, storage and transport
 Multisports
 Tracing and ground accessories
 Coach, referee and player
 First aid
 Fitness, bodybuilding and gym
 Swimming
 Combat sports
 Racket sports
 Athletics
 Balls
 School
 Nets and accessories

REBOUND BOARD

FOLDABLE REBOUND BOARD



WEIGHT	DEPTH	WIDTH	HEIGHT
11.8 kg	100 cm	40 cm	40 cm

Ideal for practising and perfecting technical skills. Makes ground passing drills easier and ensures excellent stability thanks to its side reinforcements. Folds easily and is easy to carry thanks to its handle. Can be used in two positions: flat or inclined for volley training.

Reference: 064126

Unit

• REBOUND BOARD « *L'Originale* »



« *L'Originale* » IN 4 KEY WORDS:

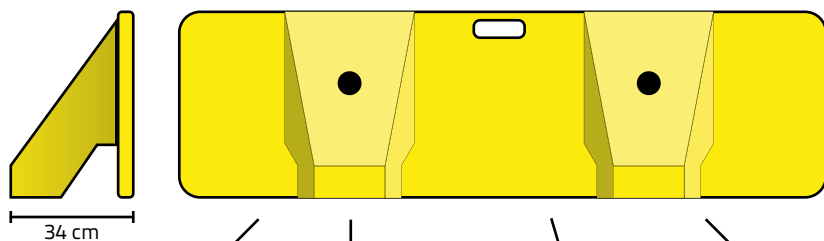

34 cm

HANDY AND STABLE
One-piece design and optimum distribution of the ballast weight

CONTACT SURFACE
Perfect flat, proven filling process

DURABLE
Quality of selected materials and French know-how

VERSATILE
Multiple possible positions



Already used by numerous European and French professional clubs and federations as well.



Easy transport



WEIGHT	LENGTH	WIDTH	HEIGHT
23 kg	180 cm	34 cm	50 cm

«L'Originale» The tried-and-tested soccer rebound board reproduces the natural qualities of a pass or a shot due to its weighted base, its balance and its durable components.

The rebound board offers unlimited possibilities for your passing & sequence exercises, kickbacks and shots. On your own or in a group, it can be used as a one-two lane, a shooting target, a relay or even as a mini-goal. Fun and easy, it is also appreciated by the youngest in the conception of circuits. Highly-resistant and ultra-durable materials, the components have been all selected for their reliability and high responsiveness.

Specific attention has been paid to the long-term flatness of the contact surface and the quality of the rebound. In addition, the distribution of the ballast weight gives excellent stability and perfect balance even under the most powerful shots.

Reference: 064118

Yellow

Reference: 064118

Red

BALL TENNIS / FUTNET / MINI-TENNIS KIT

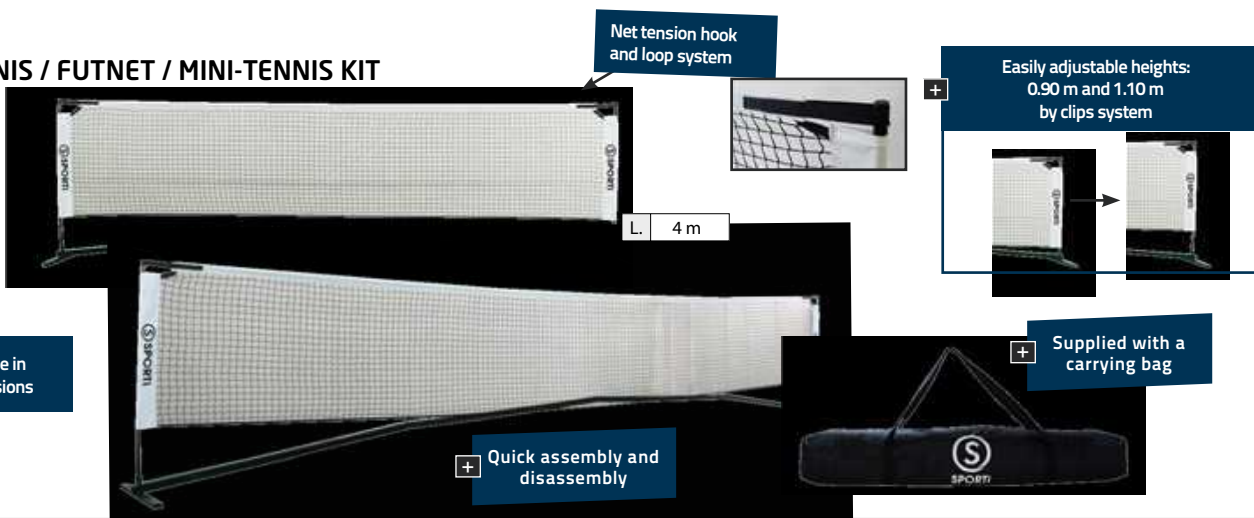

Available in 2 dimensions

L. 6 m

Set for both ball-tennis and mini-tennis. Steel rectangular structure very stable due to the wideness of its feet which avoid a lateral tip over as well as a back and forth tip over. Designed to use it on hard floor, grass and synthetic pitch. Very practical and easy to set up, this kit can be assembled and disassembled very quickly. Delivered with a net PE 2 mm, mesh 40 mm. Easy to carry due to its bag. Available in 2 lengths: 4 m and 6 m. 2 easily adjustable heights: 0.90 m and 1.10 m.

Reference: 099046	4 m	Reference: 099047	6 m
Reference: 099046F	4 m net	Reference: 099047F	6 m net
Reference: 0990475	Carrying bag alone (compatible 4 and 6 m.)		

KIT FUTNET 4 M / 6 M



KIT FUTNET 4 M - Ref: 099042	KIT FUTNET 6 M - Ref: 099043
-FUTNET net 4 m (099046)	-FUTNET net 6 m (099047)
-Land marking kit (099045)	-Land marking kit (099045)

Reference: 099045	Land marking kit (roll + 15 stakes)
Reference: 099044	Kit of 15 stakes



ATOUT KIT is suitable for any types of grounds: sand, grass, synthetic floors, bitumen, wooden floors, etc. It can be adapted both indoor and outdoor on lengths you need. Quick and easy to move thanks to its small size.

SET OF 4 LOOPS + PEGS



These loops allow to delimit a playground on a soft soil (lawn, sand, etc.). Delivered with 4 steel pegs.

Reference: 069229 Unit

ELASTOMERIC STRIP



Elastomeric strip very extensible. Available in 20 m, 30 m and 40 m and 2 colours (orange and blue). Sold without tape dispenser.

Reference: 069112	20 m
Reference: 069113	30 m
Reference: 069114	40 m

FIXING CONE IRON BASE



Allows to stabilise your different pitches and playgrounds both inside and outside (grass, sand, synthetic, wooden floor, etc.).

Reference: 069064	Unit
-------------------	------

Sports bags, storage and transport
 Multisports
 Tracing and ground accessories
 Coach, referee and player
 First-aid
 Fitness, bodybuilding and gym
 Swimming
 Combat sports
 Racket sports
 Athletics
 Balls
 School
 Nets and accessories

FOLDABLE FUTSAL FLEXI-GOAL®



Self-weighted structure +

Size : 3 x 2 m



Assembly in 2 minutes +



Delivered with a carrying bag +

RECYCLED
RECYCLABLE

WIDTH	HEIGHT
3 m	2 m

This self-weighted goal is specially designed for futsal. It can be mounted and dismantled in 2 minutes. Light and resistant steel structure. Easy to carry. Delivered with a carrying bag. Non-skid pads under goal base to protect indoor ground. White polyester net 2.4 mm knotless, 5 x 5 cm mesh. Dimensions: 3 x 2 m, 1 m depth.

Reference: 064442

Goal 3 x 2 x 1 m

Unit

BALLASTED BAG FOR GOAL



Polyester bag to ballast (maximum capacity of 20 kg.) allowing to secure goals and mini goals. Easy handling with a large handle.

Reference: 064044

Unit

Sports bags, storage and transport
Multisports
Tracing and ground accessories
Coach, referee and player
First aid
Fitness, bodybuilding and gym
Swimming
Combat sports
Racket sports
Athletics
Balls
School
Nets and accessories

FLEXI-GOAL® FOLDABLE FOOTBALL GOALS



Assembly in 2 minutes



3 sizes: 2.40 x 1.20 m / 3.60 x 1.80 m / 4 x 1.5 m



This goal can be used on all ground types (grass, synthetic and hard grounds, etc.). It can be assembled and disassembled in 2 minutes. Light and resistant steel structure. Easy to carry. Delivered with a carrying bag. 4 pegs in "U" shape included. Non-skid pads under goal base to protect indoor ground.

Reference: 064439	Goal 2.40 x 1.20 m, depth 0.7 m	Unit
Reference: 064438	Goal 3.60 x 1.80 m, depth 1 m	Unit
Reference: 064437	Goal 4 x 1.50 m, depth 1 m	Unit

• PVC FOLDING GOAL 4 X 1.50 M



Dimensions	
L.	400 cm
H.	150 cm
D.	135 cm
Tube	
∅	7 cm



Folds flat in 30 seconds



UPVC goal very resistant and flexible in 4 x 1.5 m. Easily adjustable in 3x1.5m. Tubes diameter: 70 mm. Perfect for trainings and matches of U6 and U9 categories as well as for your tournaments. Easy to carry. Foldable: it becomes entirely flat in 30 seconds which facilitates its storage against a wall. Thanks to the tubes locking by clip system (seals locking) the goal is very well kept. Delivered with a white net 2.5 mm twisted PE. Simple mesh 85 mm knotted. Easy to set up due to the split rings supplied. Delivered with pegs in U shape. UPVC structure of the goal is guaranteed 2 years.

Reference: 064103	Goal 4 x 1.5 m	Unit
Reference: 064103F	Spare net	Unit

STEEL FOLDING M



Dimensions	
L.	L.
H.	D.
L.	120 cm
H.	80 cm
D.	60 cm

Tube	
Ø	3.2 cm



Possibility to use a weighted base 063344



Metal structure. Very practical due to its compact design when folded. Delivered with its net (white, 2 mm twisted PE, simple mesh 100 mm with knot) and pegs.

Reference: 064205U Unit
 Reference: 064205U From 2
 Reference: 064205F Spare net + Red hooks

TWO-IN-ONE WEIGHTED BASE FOR GOALS AND DUMMIES



Base		For tube	
W.	12 Kg	Ø	max: 40mm

LENGTH	WIDTH	HEIGHT
50 cm	32 cm	11.2 cm

Claws on one base side allowing to weight mini goals and thus avoid their toppling. It is made in such a way that claws are put on the bar which is behind mini goals. It is compatible with all mini goals with tube diameter until 40mm. One base is enough for a mini goal. It also allows to hold dummies in place on smooth or synthetic surfaces due to all holes which are on the top of the base. Colour: Black.

Reference: 063344 Unit

REVERSIBLE MINI GOAL 90 x 70 x 56 CM



Possibility to use a weighted base 063344

Tube	
Ø	2.5 cm

WIDTH	HEIGHT	DEPTH
90 cm	70 cm	56 cm

Metal structure. Delivered with net (black, 2mm twisted PE, simple mesh 100mm with knot), 4 pegs and instructions for an easy assembly. This goal is reversible and not foldable.

Reference: 064129 Unit
 Reference: 064129F Spare net + Red hooks

REVERSIBLE MINI GOAL 120 x 90 x 60 CM

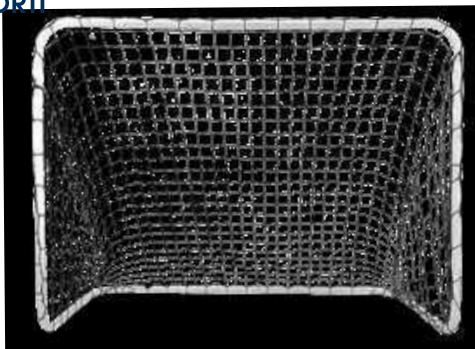

Tube	
Ø	2.5 cm

WIDTH	HEIGHT	DEPTH
120 cm	90 cm	60 cm

Metal structure. Delivered with net (black, 3mm braided PP, simple mesh 45mm without knot), pegs and instructions for an easy assembly. This goal is reversible and not foldable.

Reference: 064214 Unit
 Reference: 064214F Spare net

REVERSIBLE MINI GOAL 200 x 130 x 90 CM

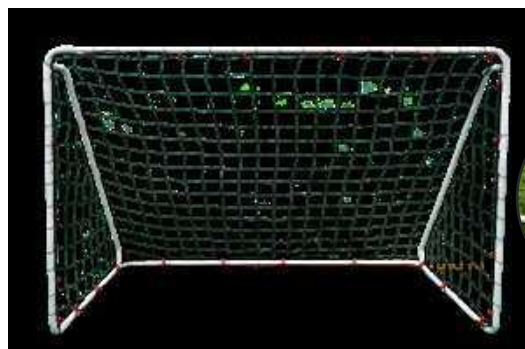

Possibility to use a weighted base 063344

Tube	
Ø	2.5 cm

WIDTH	HEIGHT	DEPTH
200 cm	130 cm	90 cm

Metal structure. Delivered with net (black, 2 mm twisted PE, simple mesh 100 mm with knot), 6 pegs and instructions for an easy assembly. This goal is reversible and not foldable. 2 reinforcement bars at the back.

Reference: 064130 Unit
 Reference: 064130F Spare net + Red hooks

REVERSIBLE MINI GOAL 300 x 200 x 120 CM

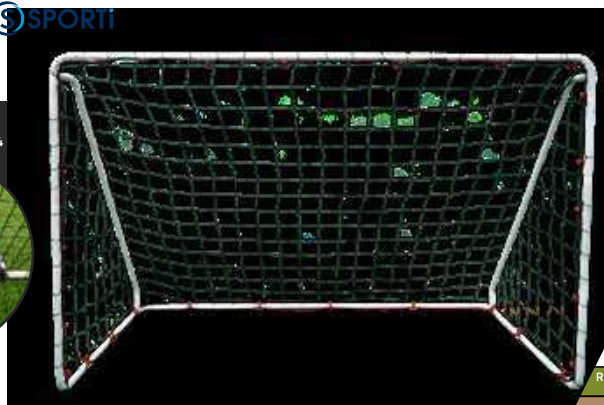

Tube	
Ø	2.5 cm

WIDTH	HEIGHT	DEPTH
300 cm	200 cm	120 cm

Reference: 064131 Unit
 Reference: 064131F Spare net + Red hooks

«POP UP» FOLDING RECTANGLE MINI GOAL (PAIR)



Delivered with a carrying bag

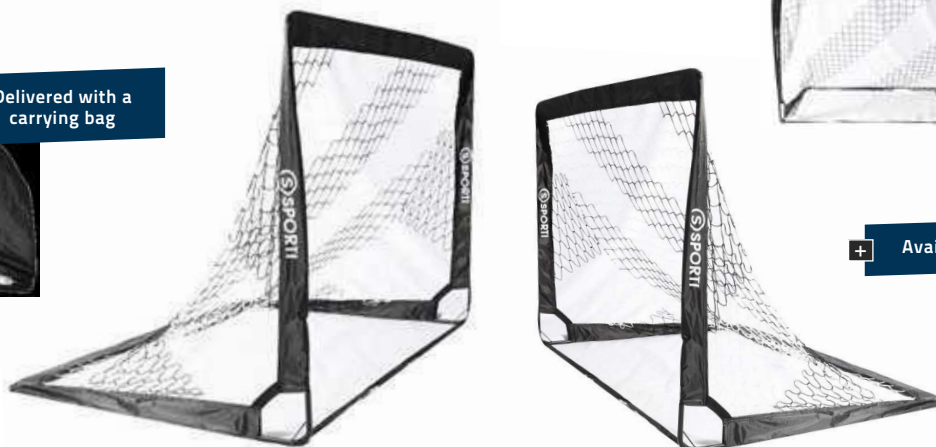

Available in 2 sizes



Pop up folding mini goals pair. It folds up and folds down very quickly. Easy to fold and to carry due to its carrying bag.

Reference: 064203

120 x 90 x 90 cm. - Pair

Reference: 064204

180 x 120 x 120 cm. - Pair

• FOLDABLE GOAL «SECURE»

Delivered with a carrying bag



Assembly in 2 minutes

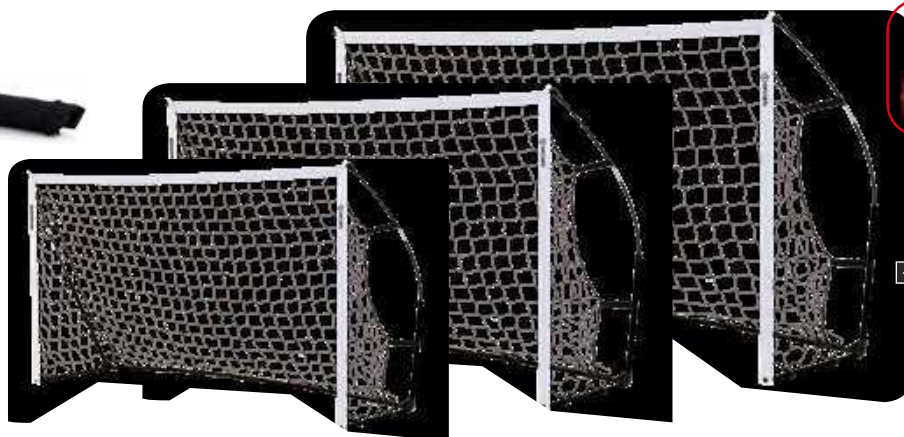
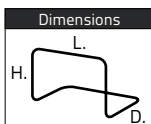

This new concept of multisport folding goal is assembled and disassembled in 2 minutes, light and resistant. Fixing pegs included. Easy to transport. Supplied with a carry bag.

Reference: 064167

L. 182 x H. 121 x D. 70 cm.

Unit

Reference: 064168

L. 244 x H. 152 x D. 80 cm.

Unit

Reference: 064169

L. 300 x H. 200 x D. 100 cm.

Unit

ALUMINIUM FOLDING MINI GOAL

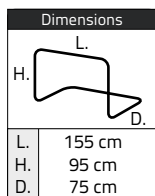

L. 155 cm
H. 95 cm
D. 75 cm

Foldable in a few seconds

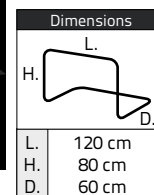

L. 120 cm
H. 80 cm
D. 60 cm

Tube	
Ø	3.8 cm

You can assemble it in 15 seconds and 3 movements. It has a compact design, is robust and light. Delivered with a honeycombed net. Easy transport. For better stability, it is recommended to use a weighted base (Reference 063344).

Reference: 064211

Goal 120 x 80 x 60 cm / W. 8.5 kg.

Unit

Reference: 064211F

Spare net 120 x 80 x 60 cm

Unit

Reference: 064213

Goal 155 x 95 x 75 cm / W. 10.5 kg.

Unit

Reference: 064213F

Spare net 155 x 95 x 75 cm

Unit

MINI GOALS

FOLDING ALUMINIUM MINI GOAL ELITE



Foldable in a few seconds

DISCOVER **IN VIDEO**

2026 NEW new colours
new size 120 cm

Foldable in a few seconds

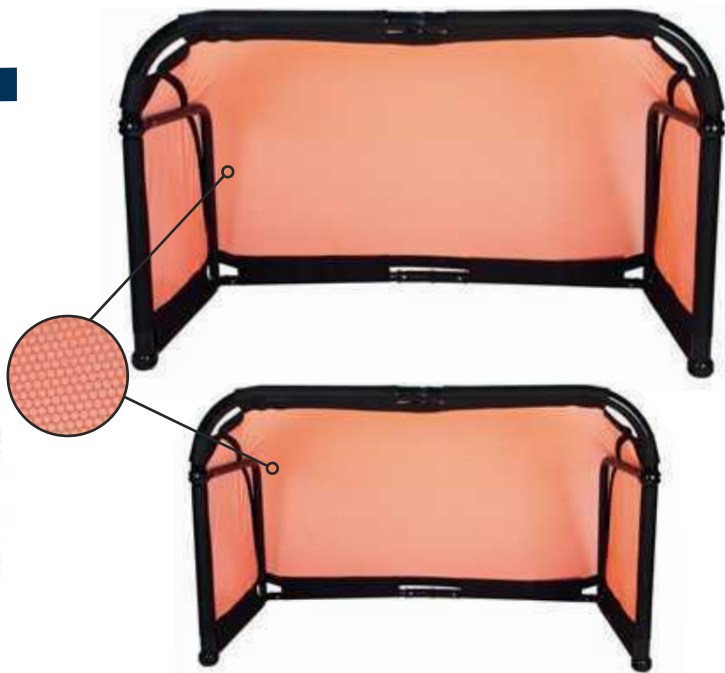

	064247	064248
	L. 120 cm H. 80 cm D. 60 cm	L. 155 cm H. 95 cm D. 75 cm

	064247	064248
Tube	WEIGHT 7.5 kg	WEIGHT 8.1 kg
Ø	5.0 cm	

Assembled in 15 seconds and 3 movements. Very compact, very robust and light. Supplied with very resistant and high visibility honeycomb net. Net delivered assembled. Easy transportation. Indoor and outdoor use. Available in 2 dimensions and 3 colours: Blue, Neon yellow and neon orange.

- Reference: 064247 Goal 120 x 80 x 60 cm.
- Reference: 064247F Spare net for ref 064247
- Reference: 064248 Goal 155 X 95 X 75 cm.
- Reference: 064248F Spare net for ref 064248

• SELF-WEIGHTED AND FOLDING ALUMINIUM MINI GOAL



2 sizes available



Foldable in a few seconds

	064064
	L. 120 cm H. 90 cm P. 70 cm

	064065
	L. 155 cm H. 95 cm P. 80 cm



Quick folding without tools



DISCOVER **IN VIDEO**

	064065	064064
WEIGHT	17 kg	16 kg



Mini goal combining robustness of an aluminium goal, stability of a self-weighted goal and convenience of a folding goal. Its 80 mm section aluminium frame and its 32 and 38 mm self-weighted rear structure make it a very stable goal for safe practice. Foldable in a few seconds, it's easy to transport, store and it's not bulky. The net (white twisted PE 2.5 mm, single mesh 70 mm knotted) is easily installed thanks to the clips on the frame and the split rings. Pegs in "U" shape included. Sold individually.

- Reference: 064064 Goal 120 x 90 x 70 cm
- Reference: 064064F Spare net + red hooks
- Reference: 064065 Goal 155 x 95 x 80 cm
- Reference: 064065F Spare net + red hooks
- Reference: 060030 White net hook for goal - Unit
- Reference: 060036 Set of 12 red hooks for mini goal

Sports bags, storage and transport
Multisports
Tracing and ground accessories
Coach, referee and player
First aid
Fitness, bodybuilding and gym
Swimming
Combat sports
Racket sports
Athletics
Balls
School
Nets and accessories

• SELF-WEIGHTED ALUMINIUM MINI GOAL



Possibility to use a weighted base 063344



+ Foldable



064232	
L.	120 cm
H.	80 cm
D.	60 cm

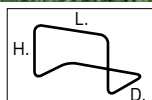

064013	
L.	150 cm
H.	100 cm
D.	70 cm



Round tube frame of 80 mm and foldable rear support tube of 38 mm to facilitate its transport and storage. The net (2.5 mm twisted PE green, simple mesh 70 mm with knots) is very easy to install thanks to the clips on the frame and to the split rings delivered with pegs in U shape. It is self-weighted, therefore it brings it a lot of robustness, stability and security. Sold by the unit.

Reference: 064232 Goal L. 120 x 80 x 60 cm. - 15.5 kg

Reference: 064232F Spare net + Red goal net hook

Reference: 060030

Reference: 060036

Reference: 064013

Goal L. 150 x 100 x 70 cm. - 19 kg

Reference: 064013F

Spare net + Red goal net hook

White sliding hook for goal - per unit

Set of 12 red goal net hook for mini goal

• REVERSIBLE FIXED MINI GOAL 120CM



+ 2 goals = 4 sizes!



064067	
L.	150 cm
H.	100 cm
D.	70 cm



REVERSIBLE

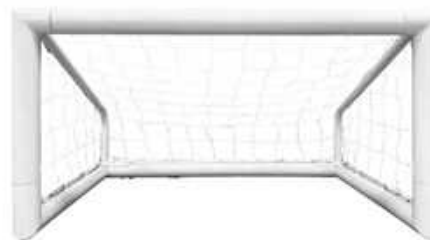

064067	
L.	150 cm
H.	70 cm
D.	100 cm

064066	
L.	120 cm
H.	80 cm
D.	60 cm



REVERSIBLE

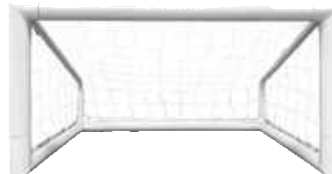

064066	
L.	120 cm
H.	60 cm
D.	80 cm

Reference: 064066

Reference: 064066F

Reference: 064067

Reference: 064067F

Reference: 060052

Goal L.120 x H.80 x D.60 cm - W.14kg

Spare net + hooks for ref 064066

Goal L.150 x H.100 x D.70 cm - W.17kg

Spare net + hooks for ref 064067

Set of 40 hooks

TARGET WITH WEIGHTED BASE FOR HANDBALL GOAL



Delivered with a carrying bag

Weighted base

DISCOVER IN VIDEO

600 deniers polyester net. Ballast included to keep the net straight and taut. Quick fixing on the crossbar and the posts due to its hook and loop straps

Reference: 064014 For HANDBALL goal

ADJUSTABLE HANDBALL TARGET



Easy mounting



Delivered with its carrying bag

Support	
L.	50 cm
w.	50 cm

Target	
L.	34 cm
w.	34 cm

Made in coating polyester tarpaulin very resistant and easy to install due to its hook and loop system, this set of 4 adjustable targets (2x2) can be your ideal partner for your penalty sessions. Colour: red.

Reference: 064105 Unit

TARGET FOR HANDBALL GOAL



3m x 2m

Target	
L.	40 cm
H.	40 cm



Dimensions	
L.	300 cm
H.	200 cm

Handball goal target in nylon for precision work. It has 4 numbered targets with a net behind each target to make the ball recovery easier. Fixing by elastic straps.

Reference: 064111

Unit - 18 sandows provided

Fixing by elastic straps



With recovery net



REDUCER FOR HANDBALL GOAL



Fixing by elastic straps



LENGTH	WIDTH
300 cm	30 cm

Made in coating polyester tarpaulin very resistant and easy to install thanks to its velcro system, this goal reducer allows you to change the size from 3 x 2m to 3 x 1.7 m to have a mini handball goal. Colour: Blue. Sold by the unit.

Reference: 065057

Unit

FOLDING REDUCER FOR HANDBALL GOAL



Foldable in 2

Thickness 8 cm



THICKNESS
8 cm

Module in rigid foam of 3 m x 30 cm x 8 cm, allowing to reduce your goal at 170 m. Tarpaulin in PVC 650 g/m², class M4 fireproof. Fixing by hook and loop straps. Foldable in two to facilitate the storage.

Reference: 065072

Unit

HANDBALL GOAL PVC 2.40 X 1.70 M



Dimensions

L.	240 cm
H.	170 cm
D.	108 cm

Structure

A.	Ø70 mm
B.	Ø60 mm
C.	Ø38 mm



+ Foldable in 30sec



This PVC hand-ball goal is easy to assemble without tools. Easy folding too (see instructions), it's a time-saver at the end of session and a space saving that will simplify your storage. Delivered with a 2.5 mm twisted PE net, 50mm mesh, white net knotted and pegs in 'U' shape. Suitable for indoor and outdoor use. Tube of 70 mm diameter in front and back of the structure of 60 and 38 mm diameter.

Reference: 064246
Reference: 064246F

Unit
Spare net

POP-UP BABYHAND



+ Available in 2 sizes

064239	
L.	180 cm
H.	120 cm
D.	120 cm

064238	
L.	140 cm
H.	100 cm
D.	100 cm



+ Delivered with a carrying bag



Pair of pop-up mini goals, designed for babyhand and mini-handball. Folds and unfolds very quickly. Lightweight, easy to carry and store thanks to its carrying case.

Reference: 064238 140 x 100 x 100 cm - Pair
Reference: 064239 180 x 120 x 120 cm - Pair

BABY-HAND KITS WITH POP-UP GOALS



x5

x5



+ Available in 2 sizes



x10



Kits include:

- 1 pair of babyhand pop-up goals (140 x 100 x 100cm OR 180 x 120 x 120cm)
- 1 set of 24 marking discs - ref 063303
- 10 first step handball orange - ref 067083
- 10 XXS Size bibs - ref 063209 (2 matching colours)
- 1 Team sports bag - ref 078111

Reference: 064243 Babyhand set n°1 with goals 140 x 100 x 100 cm - Pair
Reference: 064244 Babyhand set n°2 with goals 180 x 120 x 120 cm - Pair



Sports bags, storage and transport
Multisports
Tracing and ground accessories
Coach, referee and player
First aid
Fitness, bodybuilding and gym
Swimming
Combat sports
Racket sports
Athletics
Balls
School
Nets and accessories

• FOLDABLE «SECURE» MINI-HAND GOAL



Dimensions	
L.	240 cm
H.	170 cm

+ Assembly in 2 minutes

+ Delivered with a carrying bag



Handball goal very portable and foldable. Adaptable for gymnasiums and synthetic surfaces. Quick installation in 2 minutes. Storage cover supplied.

Reference: 064237

Unit

• INFLATABLE MINI-HANDBALL GOAL



Dimensions	
L.	240 cm
H.	170 cm
D.	110 cm

Assembly in 45 seconds! +



+ Delivered with:
1 double action hand pump
+ 8 ballasting bags
+ 4 pegs
+ 1 repair kit
+ 1 carrying bag



This new model of mini-handball goal swells in 45 seconds. With its net kit preassembled, it allows you to optimise your assembly and tidying time. Light and flexible structure facilitating transport. High wear resistance thanks to its PVC covers.

Reference: 064430

Pair

• INFLATABLE SANDBALL GOAL

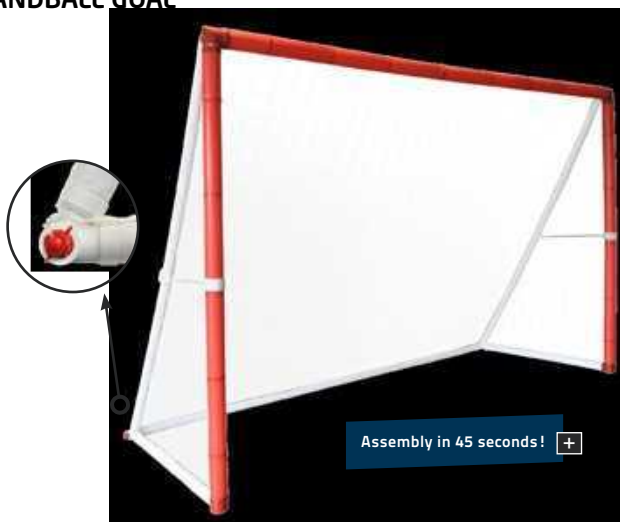

Dimensions	
L.	300 cm
H.	200 cm
D.	124 cm

Assembly in 45 seconds! +

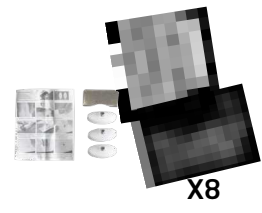

+ Delivered with:
1 double action hand pump
+ 8 ballasting bags
+ 4 pegs
+ 1 repair kit
+ 1 carrying bag



This sandball goal swells in 45 seconds. With its preassembled net kit, it allows you to optimise your assembly and tidying time. Light and flexible structure facilitating transport. High wear resistance due to its PVC covers.

Reference: 064431

Unit

FLEXI'GOAL® FOLDABLE HANDBALL GOALS



Dimensions	
L.	240 cm
H.	170 cm
D.	100 cm

Available in 2 sizes: 2.40 x 1.70m and 3 x 2m

Dimensions	
L.	300 cm
H.	200 cm
D.	100 cm

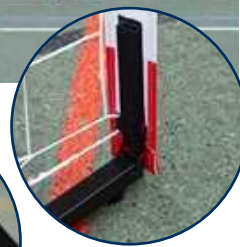

Delivered folded in a carrying bag



DISCOVER IN VIDEO



This goal can be used on all ground types (grass, synthetic and hard grounds, etc.). It can be assembled and disassembled in 2 minutes. Light and resistant steel structure. Easy to carry. Delivered with a carrying bag. Non-skid pads under goal base to protect indoor grounds.

Reference: 064240
Reference: 064241

Goal 2.40 x 1.70 m / depth 1 m
Goal 3 x 2m / depth 1 m

Unit
Unit

HANDBALL STARTER KIT



This kit includes:

- 2 Flexi-Goal hand goals - ref 064240
- 10 first step handball orange - ref 067083

- 20 Bibs XS size - ref 063209 (2 matching colours)
- 1 Team sports bag - 078111

Reference: 064245

Kit

Sports bags, storage and transport
Multisports
Tracing and ground accessories
Coach, referee and player
First-aid
Fitness, bodybuilding and gym
Swimming
Combat sports
Racket sports
Athletics
Balls
School
Nets and accessories

HANDBALL/BASKETBALL INFLATABLE DUMMY



Rights itself automatically

WIDTH 60 cm HEIGHT 240 cm

PVC inflatable dummy, width of 60 cm and height of 240 cm (to the top of the hand). Ideal for setting up different training sessions in handball and basketball. Once the base is filled with water and the upper part is inflated, it offers excellent stability and safe use. Easy to move thanks to side handles, it automatically rights itself after impact.

Reference: 063499 Unit

FLOOR BABY BASKETBALL HOOP



Ring
Ø 41 cm

Base
Ø 77 cm



RECYCLABLE
HEIGHT 85 cm

Designed for beginners, composed of a large base and a basket at an appropriate height. Tube of 21 mm diameter and net of 4 mm diameter in polypropylene. Delivered with a net.

Reference: 064010 Unit

BUST FOR TRAINING



Delivered single or in set with 1 fillable base, 1 pole and 1 hook and loop fastener (Ø 25 mm – 1.50 m H.).

Reference: 064148 Single bust
Reference: 064231 Complete set
Reference: 064192 Single hook and loop fastener

BASKETBALL STARTER KIT



This kit includes:
- 4 Baby basketball baskets - ref 064010
- 4 Discovery basketballs - ref 067110
- 4 Rubber basketballs size T3- ref 067282
- 20 XXS size reversible bibs - ref 063250 (2 matching colours)
- 1 set of 24 markers discs -ref 063303

Reference: 064051 Kit

BASKETBALL GOGGLES



Frame in PVC (polyvinyl chloride), to mask the visibility of the ball in order to work the basketball dribble. Adjustable strap, both for children and adults.

Reference: 064139 Unit

Sports bags, storage and transport
Multisports
Tracing and ground accessories
Coach, referee and player
First aid
Fitness, bodybuilding and gym
Swimming
Combat sports
Racket sports
Athletics
Balls
School
Nets and accessories

• WALL MOUNTED BASKETBALL



Backboard	
H.	71 cm
L.	109 cm
w.	4 cm

Ring	
Ø	45 cm

Ring tube	
Ø	16 mm

WEIGHT
9 kg

Composed of a rectangle in HDPE, of a steel red ring and a net in white PP 1.3 mm. Both inside and outside use. Delivered with steel support, screws, washers and dowels. The hoop is not intended to hang on or smash, but to cushion the ball.

Reference: 064003

Unit

• ADJUSTABLE MINI-BASKETBALL BASKET FROM 1.65 M TO 2.20 M



+ Transparent backboard

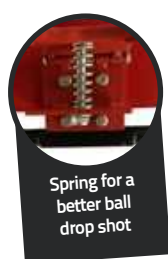

Spring for a better ball drop shot

WEIGHT
10.5 kg

Post	
Ø	45 cm
Ø	50 cm

Ring	
Ø	38 cm

Ring tube	
Ø	13 mm

Backboard	
H.	60 cm
L.	85 cm
w.	3 cm

Base	
H.	14 cm
L.	72 cm
w.	54 cm

• ADJUSTABLE MINI-BASKETBALL BASKET FROM 2.30 M TO 3.05 M



+ Reinforced backboard at the rear

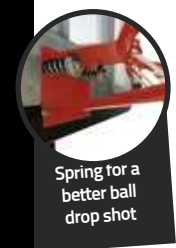

Spring for a better ball drop shot

WEIGHT
23 kg

Post	
Ø	69 cm
Ø	75 cm

Ring	
Ø	45 cm

Ring tube	
Ø	16 mm

Backboard	
H.	71 cm
L.	109 cm
w.	4 cm

Base	
H.	22 cm
L.	115 cm
w.	76 cm

Mobile basketball adjustable from 2.30 m to 3.05 m (6 possible positions). Easy to move, you can ballast with water (110 kg) or sand its base in HDPE with wheels to ensure stability. It is composed of 3 steel tubes, a HDPE rectangle backboard with steel reinforcement in "Y" at the rear, a steel red ring with spring. Delivered with a net in white PP 1.3 mm. Both inside and outside use.

Reference: 064002

Unit

Reference: 064001

Unit

Sports bags, storage and transport
Multisports
Tracing and ground accessories
Coach, referee and player
First aid
Fitness, bodybuilding and gym
Swimming
Combat sports
Racket sports
Athletics
Balls
School
Nets and accessories

BAG FOR 3 PETANQUE BALLS



LENGTH	WIDTH	HEIGHT
24 cm	9 cm	8 cm

Semi-rigid, highly durable petanque bag made of 600D polyester, designed to hold and protect your 3 balls. Features a flap with a double zip closure and a carry handle. Colour: Black. Delivered without balls.

Reference: 078003 Unit

PETANQUE SHOULDER BAG



LENGTH	WIDTH	HEIGHT
16 cm	25 cm	30 cm

Shoulder bag featuring a large zippered compartment and a zippered pocket at the front. The lower part, with a height of 9cm, is equipped with padding that can hold and protect your 3 petanque balls and jacks. Material: 600D Polyester. Colour: Black. Delivered without balls.

Reference: 078004 Unit

FOLDING



Folding petanque circle made up of 8 sections for easy transport and storage. Approved by the FIPJP (International Federation of Petanque and Provençal Game), it can be used in all official competitions.

Reference: 016000 Unit

MAGNETIC BALL PICKER



Practical magnetic ball picker with a 90 cm cord and a magnet strong enough to lift a petanque ball.

Reference: 016001

SET OF 3 JACKS



Set of 3 wooden jack balls: 1 yellow, 1 red, and 1 green.

Reference: 016002

ORANGE CARD



Available at the end of March 2026



LENGTH	WIDTH
11.2 cm	7.7 cm

Reference: 063190

Sports bags, storage and transport

Multisports

Tracing and ground accessories

Coach, referee and player

First aid

Fitness, bodybuilding and gym

Swimming

Combat sports

Racket sports

Athletics

Balls

School

Nets and accessories

RUGBY TEE



PVC rugby tee.

- Reference: 060096 **A** With 4 pimples **RECYCLABLE**
- Reference: 060055 **B** Weighted - Blue or Red
- Reference: 060057 **C** Adjustable in height **RECYCLABLE**

• RUGBY TACKLE BAG



The tackle bag is the support dedicated to the perfect technique of power in contact. Article designed with a waterproof material and a high density foam interior. Neat finishes for greater resistance and durability. Available in 3 sizes: Child, Junior and Senior

- Reference: 060173E CHILD H. 65 cm / W. 4 Kg / Ø28 cm
- Reference: 060173J JUNIOR H. 130 cm / W. 13 Kg / Ø40 cm
- Reference: 060173S SENIOR H. 130 cm / W. 20 Kg / Ø45 cm

• TRAINING KIT CALIFORNIA



Easy to assemble and disassemble on all types of floor

Training kit composed of 2 aluminium posts (Ø 32 mm) that can be disassembled in 3 parts, middle posts allowing to adjust the height on 5 different levels (Maximum height: 2.43 m – Minimum height: 2.10 m). Black polyethylene net of 100 mm mesh, 9,50 m length. Delivered with a delimitation kit for pitch (9 x 18 m) with neon yellow guiding line and pegs to hold it.

Reference: 064048 Unit

RUGBY INFLATABLE



Automatically rights itself

Height of 125 cm suitable for introducing children to tackling

WIDTH 35 cm HEIGHT 125 cm

Thanks to its height of 125 cm, this contact dummy is perfectly suited for initiating kids to rugby. It has been especially designed to tackling at waist level in a fun and educational way, in complete safety. Once the base is filled with water and the upper part is inflated, it offers excellent stability. Automatically rights itself after impact.

Reference: 063498 Unit

• PERCUSSION SHIELD



The percussion shield is the ideal tool for working on offensive and defensive gestures. Article designed with waterproof material and high-density foam interior. Neat finishes for greater resistance and durability. Available in 3 sizes: Child, Junior and Senior

- Reference: 060172E CHILD H. 50 cm
- Reference: 060172J JUNIOR H. 80 cm
- Reference: 060172S SENIOR H. 95.5 cm

• COMPETITION KIT FLORIDA



Easy to assemble and disassemble on all types of floor

Competition kit Florida composed of 2 posts (Ø 40 mm) to fix in the discs to hold them on the floor, middle posts allowing to adjust the height on 5 different levels (Maximum height: 2.43 m – Minimum height: 2.10 m), 2 discs to hold the kit on the floor, 4 pegs to hold the posts on the floor, 5 pegs to fix the guiding lines on the floor (whose one spare one) and 4 guiding lines (2 for a pitch of 9 m and 2 for 18 m).

Reference: 064049 Unit

CUPS, MEDALS AND PODIUM

• SET OF 30 CUPS



Set of 30 cups composed of 10 series of 3 sizes. Average height: 33.5 cm.

Reference: 061050 Set

• SET OF 3 CUPS



Set composed of 3 cups of 3 sizes. Average height: 35.30 cm.

Reference: 061054 Set

• SET OF 12 CUPS



Set of 12 cups composed of 4 series of 4 sizes

Reference: 061048 Set n°1 Average height: 27.5 cm
Reference: 061049 Set n°2 Average height: 34.6 cm

• PODIUM MEDAL Ø50 MM



Podium medal 50 mm. Ø

Reference: 061044 VICTOIRE model, per unit: Gold, Silver or bronze
Reference: 061079 FOOTBALL model, per unit: Gold, Silver or bronze
Reference: 061078 Medal ribbon, per unit

INTEGRATED 3 PLACES MULTISPORTS PODIUM

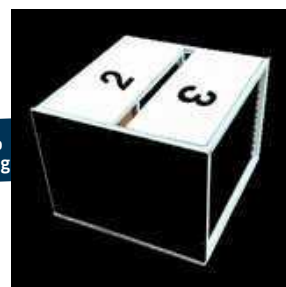
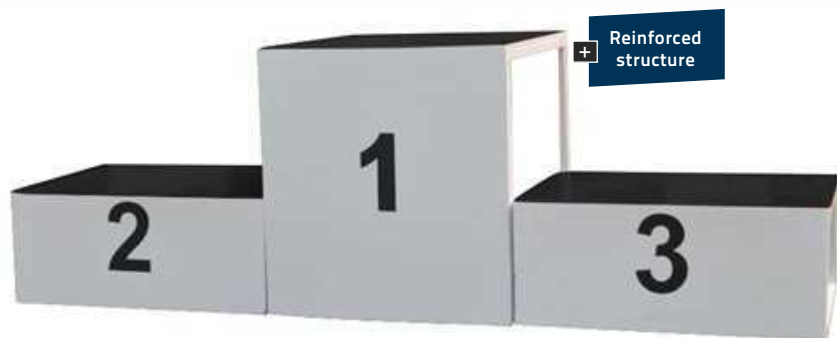

Integrated to facilitate storage



Podium n°3 only ref 025001

OVERALL WEIGHT	BOX N°2 AND 3	BOX N°1
27 kg	60 x 48 x 26cm	66 x 63 x 48 cm

Wooden white podium with white painted iron structure. Black anti-skid rubber surface on the top. Podium n°2 and n°3 could be easily stored in the podium n°1 to be easily transportable and stored. Tip: store your podium inside and avoid moisture.

Reference: 025002 Unit
Reference: 025001 Podium n°3

Tracing and ground accessories

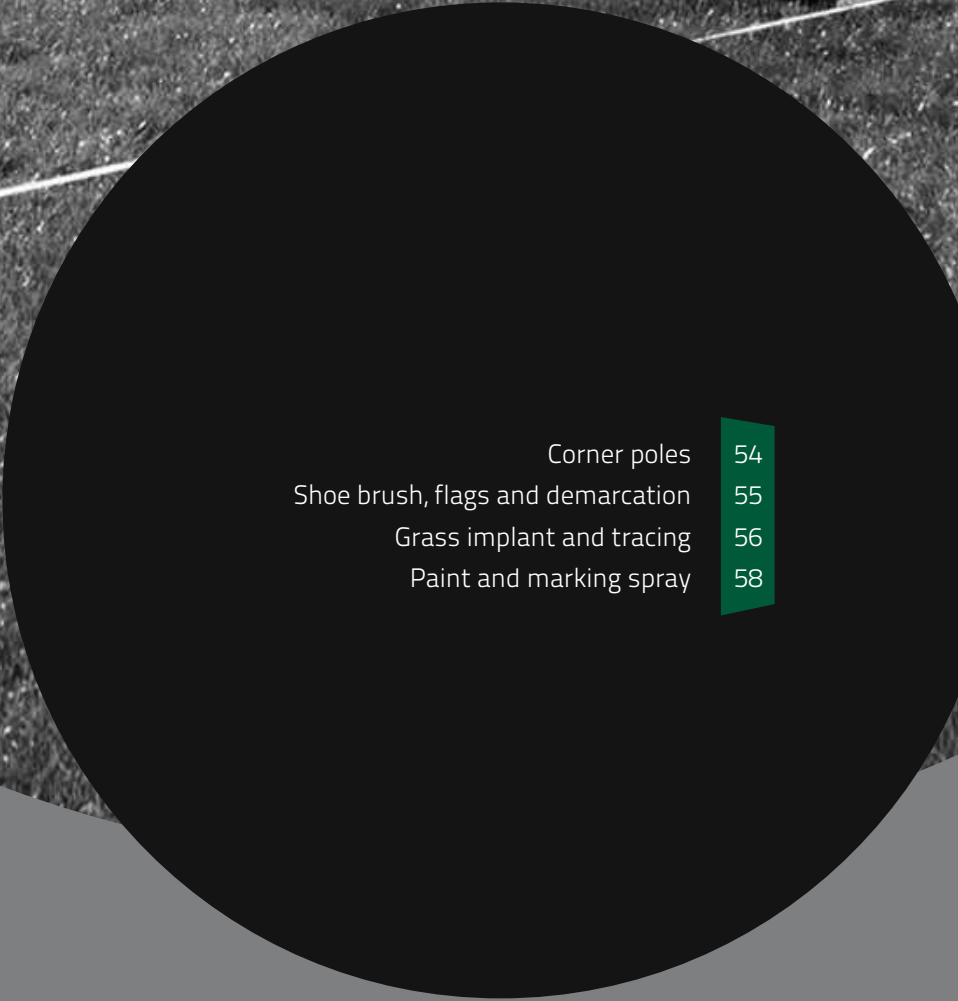

TO DISCOVER

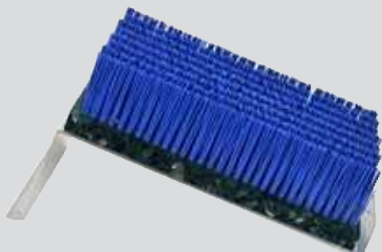

P.55



P.57



P.58



SET OF 4 FLEXIBLE CORNER POLES

SPORTi



	Pole	Flag
Ø	32 mm	w. 45 cm
L.	180 cm	L. 45 cm



Required corner poles in flexible PVC with flags. Articulated and secure system which allows the pole to fold up without danger. Colours: red, white, yellow or checkered. Supplied with bag and sheaths, height 30 cm.

Reference: 060179R	Red
Reference: 060179B	White
Reference: 060179J	Yellow
Reference: 060179D	Checkered

SET OF 4 ARTICULATED CORNER POLES

SPORTi



	Pole	Flag
Ø	32 mm	w. 45 cm
L.	180 cm	L. 45 cm



Required corner poles in PVC tube with black articulated rubber connector and a fixed support to sink into the ground. Delivered with flag and bag. Colours: red, white, yellow or checkered.

Reference: 060180R	Red
Reference: 060180B	White
Reference: 060180J	Yellow
Reference: 060180D	Checkered
Reference: 060082	PVC pole - single tube

SET OF 4 RIGID CORNER POLES

SPORTi

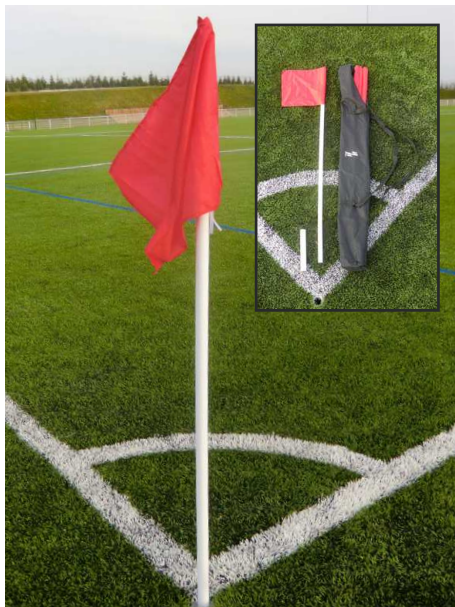

	Pole	Flag
Ø	32 mm	w. 45 cm
L.	160 cm	L. 45 cm



Required corner poles in rigid PVC with flags. Colours: red, white, yellow or checkered. Supplied with bag and sheaths, height 25 cm.

Reference: 060178R	Red
Reference: 060178B	White
Reference: 060178J	Yellow
Reference: 060178D	Checkered

SET OF 14 FLEXIBLE CORNER POLES FOR RUGBY

SPORTi

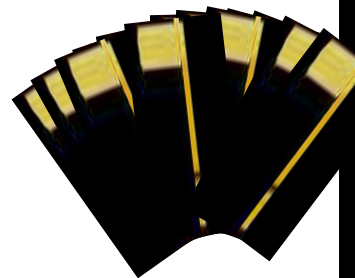

	Flag	Pole
w.	45 cm	Ø 32 mm
L.	45 cm	L. 180 cm



Required corner poles in flexible PVC with flags. Articulated and secure system which allows the pole to fold up without danger. Yellow poles and flags. Delivered with sheath and bag.

Reference: 060103	Set of 14
-------------------	-----------

LAND MARKING KIT



Provided with 15 stakes

x15



Kit included a reel, a 50 m elastic band and 15 stakes of 11 cm. It will be very useful for delimiting any type of playing area (tennis ball court, ball conserving area, etc.). Very easy to use, this 3 cm wide «buttonhole 1cm» elastic is clearly visible and has woven holes to facilitate the use of the pegs. Its stretched length can reach 100 m. Gap between every buttonhole: 2 cm.

Ref: 099045 The kit
Ref: 099044 Set of 15 stakes

SHOE BRUSH



Polyethylene

Polypropylene

SINGLE BRUSH



SINGLE SUPPORT

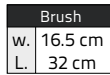
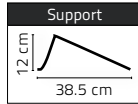

Wirehair brush on galvanized steel support that you can fix to the ground. Perfect for cleaning shoes before to return to the dressing room. Blue colour.

Reference: 060119 Unit
Reference: 060119A Single brush
Reference: 060119B Single support



FLAG FOR CORNER POLE

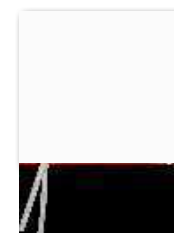

Flag Ø32 mm
w. 45 cm
L. 45 cm

Flag Ø40 mm
w. 45 cm
L. 52 cm

For corner poles : 32 mm. Available in 4 colours : red, white, yellow and checkered.

	RED	CHECKERED	YELLOW	WHITE	
Flag Tube Ø32 mm - 1.45 x L.45 cm.	Ref: 060177	Ref: 060177	Ref: 060177	Ref: 060177	
Flag Tube Ø40 mm - 1.45 x L.52 cm.	Ref: 060116	Ref: 060115	Ref: 060116		

SPARE PARTS FOR CORNER POLES

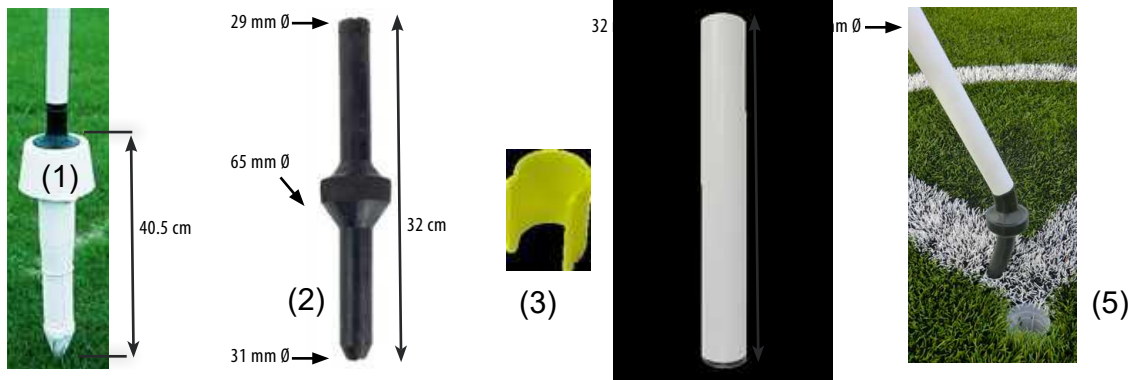

(1) Base which sinks into the ground for articulated pole. (2) Black articulated rubber connector (3) Clip allowing to hold the flag to the corner pole. Neon yellow colour. (4) Sheaths for corner poles Ø32 mm. (5) White PVC tube post only.

Reference: 060080 PVC base (1)
Reference: 060081 Connector (2)
Reference: 060118 Locking clip (3)
Reference: 060017 Sheaths for corner poles Ø32 mm (4)
Reference: 060082 White PVC tube post only (5) - Ø32 mm, H. 150 cm.



GRASS IMPLANT



Available in 4 colours

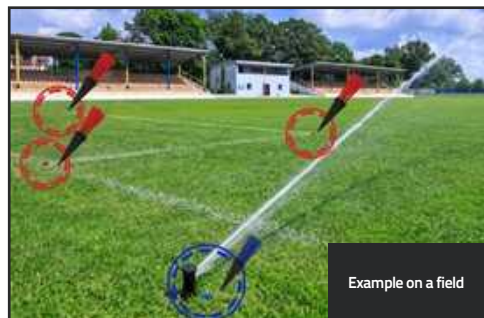

Example on a field



Function dibble implant: you sink or screw the implant

Box of 25 implants + 1 dibble



Base	Fibres
H. 10.5 cm	H. 7.5 cm

Grass implants in synthetic fibre to signal the tracking of a line or an area on an ad hoc or permanent basis. Easy to install thanks to its dibble implant, you can either screw it if the ground is flexible or help you of a hammer if the ground is harder. 4 available colours: white, yellow, blue and red. Delivered per box of 25 implants of the same colour and a dibble implant tool.

Reference: 060085
Reference: 060075
Reference: 060076

The box of 25 implants + dibble
Unit tracking
Dibble implant



ATOUT KIT is suitable for any types of grounds: sand, grass, synthetic floors, bitumen, wooden floors, etc. It can be adapted both indoor and outdoor on lengths you need. Quick and easy to move thanks to its small size.

SET OF 4 LOOPS + PEGS



These loops allow to delimit a playground on a soft soil (lawn, sand, etc.). Delivered with 4 steel pegs.

Reference: 069229 Unit

ELASTOMERIC STRIP



RECYCLABLE	
THICKNESS	WIDTH
1.2 mm	4.2 cm

Elastomeric strip very extensible. Available in 20 m, 30 m and 40 m and 2 colours (orange and blue). Sold without tape dispenser.

Reference: 069112 20 m
Reference: 069113 30 m
Reference: 069114 40 m

FIXING CONE IRON BASE



WEIGHT	DIAMETER	HEIGHT
3 kg	21.5 cm	2 cm

Allows to stabilise your different pitches and playgrounds both inside and outside (grass, sand, synthetic, wooden floor, etc.).

Reference: 069064 Unit

Sports bags, storage and transport
Multisports
Tracing and ground accessories
Coach, referee and player
Stopwatches and digital displays
First aid
Fitness and combat
Swimming
Racket sports
Athletics
Balls
School
Nets and accessories

PAINT MARKING WHEELBARROW



CAPACITY	WEIGHT
12 L	19 kg

Paint marking wheelbarrow with a 12-liter tank. Easy to handle thanks to its inflatable pneumatic wheels, it features an integrated drainage system to simplify cleaning after use. Line width: 10 cm.

Reference: 060105

Unit

• SPRAY PAINT MARKING WHEELBARROW



CAPACITY	WEIGHT
8.5 L	12 kg

Pitch line marker with spray painting to have a width of tracing from 5 to 12 cm, for the tracing of grass pitches. Very manoeuvrable thanks to its low weight. Rubberised disc wheels of 26 cm diameter. Cleaning of the spray system after each use.

Reference: 060109

Unit

PLOTTER TROLLEY CORD HOLDER



Wheel
Ø 260 mm

To trace your outdoor grounds with a cord to guide the tracing of lines. Painted steel structure equipped with 2 cords of 200 m wound on plastic rollers with rewinding handle and 1 PVC tray with 12 metal pegs. Mounted on 2 never flat wheels. Retractable grab handle.

Reference: 060083

Unit



PAINT



	CLUB	ELITE	ELITE PRO	COLOUR
USE	On grass training pitches regularly delineated.	For all types of pitches, honour and training.	High performance paint, which covers very well. Resist to bad weather and intensive passage of players.	For grass training pitches.
TRACING MODE	Roller machine	For roller or spraying machine	For roller or spraying machine	For roller or spraying machine
WEIGHT	15 Kg	15 Kg	15 Kg	12 Kg
CAPACITY	4 to 5 tracings	4 to 5 tracings	4 to 5 tracings	10 tracings
DENSITY	1.53 - 1.55	1.51	1.58	1.39 - 1.50
PH	8 / 9	8 / 9	8 / 9	7.5 / 8.5
PIGMENT	Titanium	Titanium	Titanium	Organic
ADDITIONAL INFORMATION	Perfect for training pitches or tracings of last minutes.	-	-	Available in 4 colours
REFERENCE	Reference: 060108	Reference: 060084	Reference: 060142	Reference: 060099

READY-TO-USE PAINT



+ Strong covering power

+ No more dilution problems

+ 1 can 10 L = 1 ground

High performance white tracing paint for synthetic and grass sports ground. Compatible with roller and spraying machine.

Reference: 060188

Unit

CHALK-BASED MARKING SPRAY



+ Maximum duration: 1 month

Ephemeral chalk-based spray paint ideal for very short-term floor markings. For signaling and beaconing sporting events (races, hikes) or any type of event: flea markets, markets, shows, leisure. Available in blue, pink and orange.

Reference: 060094

Unit



TEMPORARY MARKING SPRAY



+ Maximum duration: 2 months

Temporary spray paint that is used for floor markings that should not last. Particularly suitable for markings in urban areas or on classified or protected sites. Available in red, white and orange.

Reference: 060093

Unit



Sports bags, storage and transport
Multisports
Tracing and ground accessories
Coach, referee and player
Stopwatches and digital displays
First aid
Fitness and combat
Swimming
Racket sports
Athletics
Balls
School
Nets and accessories

Coach, referee and player

Resin, cleansing cream, cleaner and player's equipment	60
Bottles and cooler	61
Bottles carrier and bottles	62
Rigid briefcase and coach bag	64
Coach notebooks and pro coaching boards	65
Coach clipboard	66
Taktifol	67
LCD coaching tablets	68
Tactic boards	70
Compressors, pumps and inflating accessories	72
Armbands	74
Measuring instruments and megaphone	76
Whistles	77
Fox 40 Whistles and referee watch	78
Refereeing	80

TO DISCOVER



P.68



P.74



P.80



Discover our range of resins and cleaners, which offers to handballers and rugby players a top quality solution to optimize their performance on the field.

• HIGH PERFORMANCE WHITE RESIN



100 ml



200 ml



500 ml



- Optimal performance: a small quantity is enough for an entire match.
- Balls and sports floors protection: composition less aggressive than a traditional product.

- Protection of player's health: natural composition rosin free, no perfume and no colouring.
- Easy cleaning of hands and floors.

Available in 3 capacities.

Reference: 063413A

Pot of 100 ml

Reference: 063413B

Pot of 200 ml

Reference: 063413C

Pot of 500 ml

• CLEANSING CREAM



- Removes efficiently the resin on hands.
- Moisturizes and protects skin.

Reference: 063473

Pot of 200 ml

• RESIN SPRAY FOR HANDBALL/RUGBY



VOLUME 200 ml

- **Playing performance:** strong grip for optimal ball retention.
- **Optimal dosage:** just spray your resin evenly, without residue.
- **Protection of balls and sports floors:** a less aggressive composition than a traditional product.
- **Protection of players' health:** natural composition without rosin, perfumes or dyes.

Reference: 063474

Unit

• FLOOR CLEANER 5 L



Ultra-concentrated solution

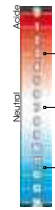

PH comparative table

- **Respect for the environment:** Pine derived degreaser
- **Respect for health:** without C.O.V (Volatile Organic Compounds)
- **High efficiency on all types of soils:** eliminates resin and black marks while preserving the soil
- **Highly concentrated solution:** for significant dilution
- **Non-foaming product**

Reference: 063450

Unit

BLOCK OF MAGNESIA

1

2



Box of 8 blocks of 56 gr of magnesia.
 ① Training: Flexible and soft grain for all sports needing a firm and sure taking in hand.
 ② Competition: Especially created for athletes who need a very strong grip due to long and difficult movements.

Ref: 033127

① Training magnesia

Ref: 033128

② Competition magnesia

LIQUID MAGNESIA



VOLUME 200 ml

200 ml flask, created with particular drying agents ensuring a strong grip in a few seconds and an absorption of all excessive perspiration.

Reference: 033130

Unit

• GREASE FOR SHOES



It softens, nourishes and waterproofs leathers. Pot of 100 ml.

Reference: 063458

750 ML BOTTLE

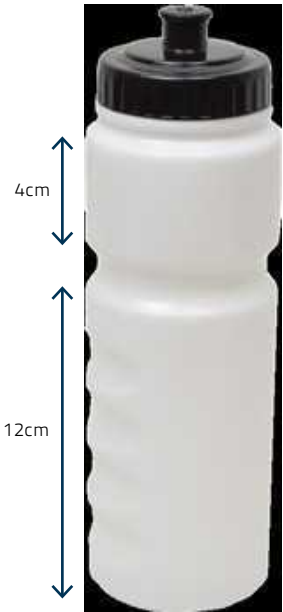

RECYCLABLE
HEIGHT
24 cm

Screw cap. Transparent strip showing the water level. Colour: white.

Reference: 062744 Unit

600 ML BOTTLE



RECYCLED
RECYCLABLE
HEIGHT
19 cm

Lightweight and easy-squeeze bottle. Ergonomic cap with large and soft drinking valve. Made of 100% BPA, BPS and BPF free polypropylene.

Reference: 062780 Unit

800 ML BOTTLE



RECYCLED
RECYCLABLE
HEIGHT
23.5 cm

Lightweight and easy-squeeze bottle. Ergonomic cap with large and soft drinking valve. Made of 100% BPA, BPS and BPF free polypropylene.

Reference: 062781 Unit

800 ML HYGIENIC BOTTLE TEAM



RECYCLED
RECYCLABLE
HEIGHT
26 cm

800ml hygienic cork to avoid contact with mouth. Transparent strip to see the water level.

Reference: 062782 Unit

BOTTLES LABELS



Label
w. 42 mm
L. 70 mm

Set of 42 labels.

Reference: 062774 Set

COOLER 10L



VOLUME 10 L LENGTH 33 cm WIDTH 22 cm HEIGHT 31 cm

Rigid cooler allowing to keep the cold packs or ice bags cold.

Reference: 066001 Unit

• ICE BOX ON WHEELS 55L



WEIGHT 6.5 kg VOLUME 55 L LENGTH 49 cm WIDTH 44 cm HEIGHT 52 cm

Its telescopic handle and large wheels will make it easier for you to transport your drinks on all terrains. Ideal for keeping your drinks or your cryotherapy devices cool. The lid is equipped with 4 slots for cups and a drain plug located at the back of the ice box will allow you to empty the melted ice. Colour: Blue.

Reference: 066006 Unit

Sports bags, storage and transport
Multisports
Tracing and ground accessories
Coach, referee and player
First-aid
Fitness, bodybuilding and gym
Swimming
Combat sports
Racket sports
Athletics
Balls
School
Nets and accessories

PVC BOTTLE CARRIER SMALL MODEL



Foldable. Central carry handle. In robust PVC. Main face allowing to put a sticker with the name of the club, of the team or a sponsor.

Reference: 063163

Unit

PVC BOTTLE CARRIER LARGE MODEL



Foldable. Central carry handle. In robust PVC. Main face allowing to put a sticker with the name of the club, of the team or a sponsor.

Reference: 063165

Unit

PVC BOTTLES CARRIER-LARGE MODEL + 8 BOTTLES 600 ML



Large model PVC bottle carrier + 8 bottles 600 ml.

Reference: 062788

Kit

PVC BOTTLES CARRIER-LARGE MODEL + 8 BOTTLES 800 ML



Large model PVC bottle carrier + 8 bottles 800 ml.

Reference: 062789

Kit

PVC BOTTLES CARRIER-LARGE MODEL + 8 HYGIENIC BOTTLES 800 ML



Large model PVC bottle carrier + 6 bottles team 800 ml.

Reference: 062790

Kit

PVC BOTTLES CARRIER-SMALL MODEL + 6 BOTTLES 600 ML



Small model PVC bottle carrier + 6 bottles 600 ml.

Reference: 062785

Kit

PVC BOTTLES CARRIER-SMALL MODEL + 6 BOTTLES 800 ML



Small model PVC bottle carrier + 6 bottles 800 ml.

Reference: 062786

Kit

PVC BOTTLES CARRIER-SMALL MODEL + 6 HYGIENIC BOTTLES 800 ML



Small model PVC bottle carrier + 6 bottles team 800 ml.

Reference: 062787

Kit

Sports bags, storage and transport
Multisports
Tracing and ground accessories
Coach, referee and player
First aid
Fitness, bodybuilding and gym
Swimming
Combat sports
Racket sports
Athletics
Balls
School
Nets and accessories

PRO BOTTLE CARRIER SMALL MODEL



LENGTH	WIDTH	HEIGHT
32 cm	27 cm	21 cm

Monobloc bottle carrier very robust which can have up to 8 bottles.

Reference: 062768 Unit

PRO BOTTLE CARRIER LARGE MODEL



LENGTH	WIDTH	HEIGHT
50 cm	27 cm	23 cm

Monobloc bottle carrier very robust which can have up to 12 bottles.

Reference: 062769 Unit
Reference: 062775 The shoulder strap

PRO BOTTLES CARRIER SMALL MODEL + 8 BOTTLES 600 ML



Very robust monobloc bottle carrier with 8 bottles 600 ml.

Reference: 062794 Kit

PRO BOTTLES CARRIER SMALL MODEL + 8 BOTTLES 800 ML



Very robust monobloc bottle carrier with 8 bottles 800 ml.

Reference: 062795 Kit

PRO BOTTLES CARRIER LARGE MODEL + 12 BOTTLES 600 ML



Large model PRO bottle carrier + 12 bottles 600 ml.

Reference: 062791 Kit

PRO BOTTLES CARRIER LARGE MODEL + 12 BOTTLES 800 ML



Large model PRO bottle carrier + 12 bottles 800 ml.

Reference: 062792 Kit

Sports bags, storage and transport
Multisports
Tracing and ground accessories
Coach, referee and player
First aid
Fitness, bodybuilding and gym
Swimming
Combat sports
Racket sports
Athletics
Balls
School
Nets and accessories

• RIGID DOCUMENT HOLDER WITH ERASABLE FACE



RECYCLED
RECYCLABLE

LENGTH 32 cm
WIDTH 24 cm

Rigid document holder with a 20*27 cm dry-erasable white writing surface on one side. Black colour. Pencils not included.

Reference: 063489

Unit

• RIGID BRIEFCASE N°2



RECYCLED
RECYCLABLE

LENGTH 32 cm
WIDTH 24 cm

Perfect around an outdoor sport ground, it protects your files from rain and wind. You can put your notebooks of A4 format inside. It has a metallic clip and a hinge on the right side. Colour: Black.

Reference: 063461

Unit

• PRO RIGID BRIEFCASE



RECYCLED
RECYCLABLE

LENGTH 34 cm
WIDTH 24 cm

Composed of 2 compartments that you can open with a hinge at the top and which has a metallic clip. The bottom compartment is big and deep enough for a notebook of an A4 format. The top compartment, flatter, can also have your papers of an A4 format. It has a transparent lid. It can be used with dry-erasable markers (delivered without pencil). Colour: Grey/Green.

Reference: 063463

Unit

MULTISPORTS BRIEFCASE



RECYCLED
RECYCLABLE

LENGTH 32 cm
WIDTH 23.5 cm

Composed of 2 sections, one of which has a pocket to keep the papers. Delivered without leaf and without pen.

Reference: 078047

Unit

BACKPACK



Padded straps and back



CAPACITY 25 L
THICKNESS 15 cm
WIDTH 30 cm
HEIGHT 44 cm

Backpack with large main compartment, 2 side mesh pockets and a large front zippered pocket for small accessories. Padded back and carrying straps for greater comfort. Material: polyester. Colour: black with reflective stripes on front.

Reference: 078002

Unit

PRO COACHING BOARD FOOTBALL



LENGTH 36 cm
WIDTH 25 cm



Composed of a magnetic pitch. Delivered with a pencil case containing pieces, 2 pens, one felt pen with a brush and one duster. The other section contains 25 detachable pages for your schemes and your notes. With zip.

Reference: 063306 FOOTBALL With 13 red pawns, 13 blue pawns and 1 black pawn

SPIRAL COACH NOTEBOOKS FOOTBALL



2 dimensions

Spiral coach notebook for 100 games and / or training sessions (100 pages - Front / back printing).

Reference: 063464 A5
Reference: 063465 A4

PRO COACHING BOARD HANDBALL / FUTSAL



LENGTH 36 cm
WIDTH 25 cm



Composed of a magnetic pitch. Delivered with a pencil case containing pieces, 2 pens, one felt pen with a brush and one duster. The other section contains 25 detachable pages for your schemes and your notes. With zip.

Reference: 063449 HANDBALL / FUTSAL With 10 red pawns, 10 blue pawns and 1 black pawn

SPIRAL COACH NOTEBOOKS HANDBALL / FUTSAL



2 dimensions

Spiral coach notebook for 100 games and / or training sessions (100 pages - Front / back printing).

Reference: 063466 A5
Reference: 063467 A4

PRO COACHING BOARD BASKETBALL



LENGTH 36 cm
WIDTH 25 cm



Composed of a magnetic pitch. Delivered with a pencil case containing pieces, 2 pens, one felt pen with a brush and one duster. The other section contains 25 detachable pages for your schemes and your notes. With zip.

Reference: 063448 BASKETBALL With 13 red pawns, 13 blue pawns and 1 black pawn

SPIRAL COACH NOTEBOOKS BASKETBALL



2 dimensions

Spiral coach notebook for 100 games and / or training sessions (100 pages - Front / back printing).

Reference: 063468 A5
Reference: 063469 A4

Sports bags, storage and transport

Multisports

Tracing and ground accessories

Coach, referee and player

First aid

Fitness, bodybuilding and gym

Swimming

Combat sports

Racket sports

Athletics

Balls

School

Nets and accessories

3D COACH CLIPBOARD FOOTBALL



RECYCLED RECYCLABLE
LENGTH 36 cm WIDTH 22.5 cm

Tactical board, erasable, rigid, in PVC with a clipboard, one side with the whole pitch and one side with a half-pitch. Delivered with a marker.

Reference: 063200 FOOTBALL

3D COACH CLIPBOARD BASKETBALL



RECYCLED RECYCLABLE
LENGTH 36 cm WIDTH 22.5 cm

Tactical board, erasable, rigid, in PVC with a clipboard, one side with the whole pitch and one side with a half-pitch. Delivered with a marker.

Reference: 063202 BASKETBALL

3D COACH CLIPBOARD RUGBY



RECYCLED RECYCLABLE
LENGTH 36 cm WIDTH 22.5 cm

Tactical board, erasable, rigid, in PVC with a clipboard. Delivered with a marker.

Reference: 063203 RUGBY

3D COACH CLIPBOARD VOLLEYBALL



RECYCLED RECYCLABLE
LENGTH 36 cm WIDTH 22.5 cm

Tactical board, erasable, rigid, in PVC with a clipboard, one side with the whole pitch and one side with a half-pitch. Delivered with a marker.

Reference: 063420 VOLLEYBALL

3D COACH CLIPBOARD HANDBALL / FUTSAL

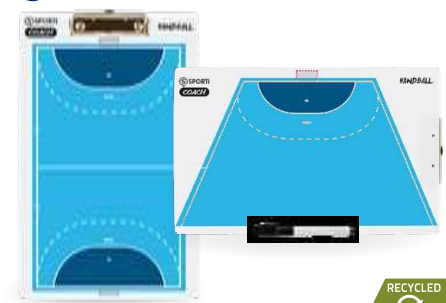

RECYCLED RECYCLABLE
LENGTH 36 cm WIDTH 22.5 cm

Tactical board, erasable, rigid, in PVC with a clipboard, one side with the whole pitch and one side with a half-pitch. Delivered with a marker.

Reference: 063201 HANDBALL / FUTSAL

COACH CLIPBOARD PICKLEBALL/BADMINTON

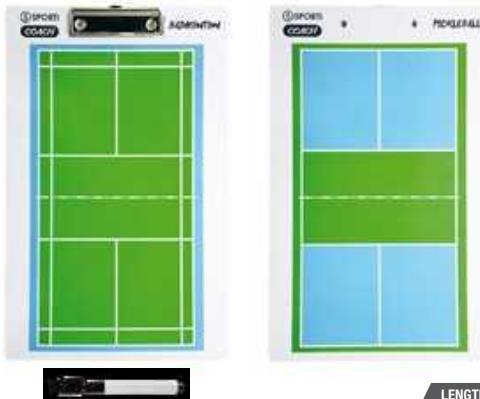

RECYCLED RECYCLABLE
LENGTH 36 cm WIDTH 22.5 cm

Rigid wipe-clean PVC board with metal clip. One side features a Badminton court, the other a Pickleball court. Supplied with a marker.

Reference: 063192

COACH CLIPBOARD TENNIS/PADEL

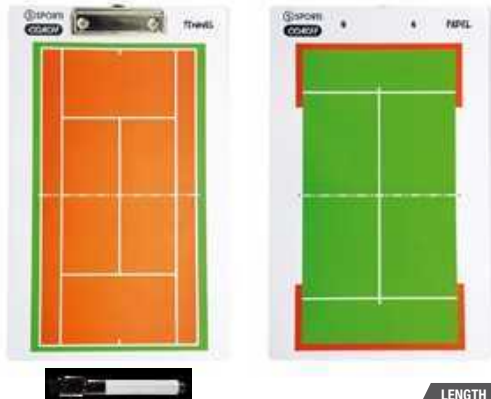

RECYCLED RECYCLABLE
LENGTH 36 cm WIDTH 22.5 cm

Rigid wipe-clean PVC board with metal clip. One side features a Tennis court, the other a Padel court. Supplied with a marker.

Reference: 063191

TAKTIFOL

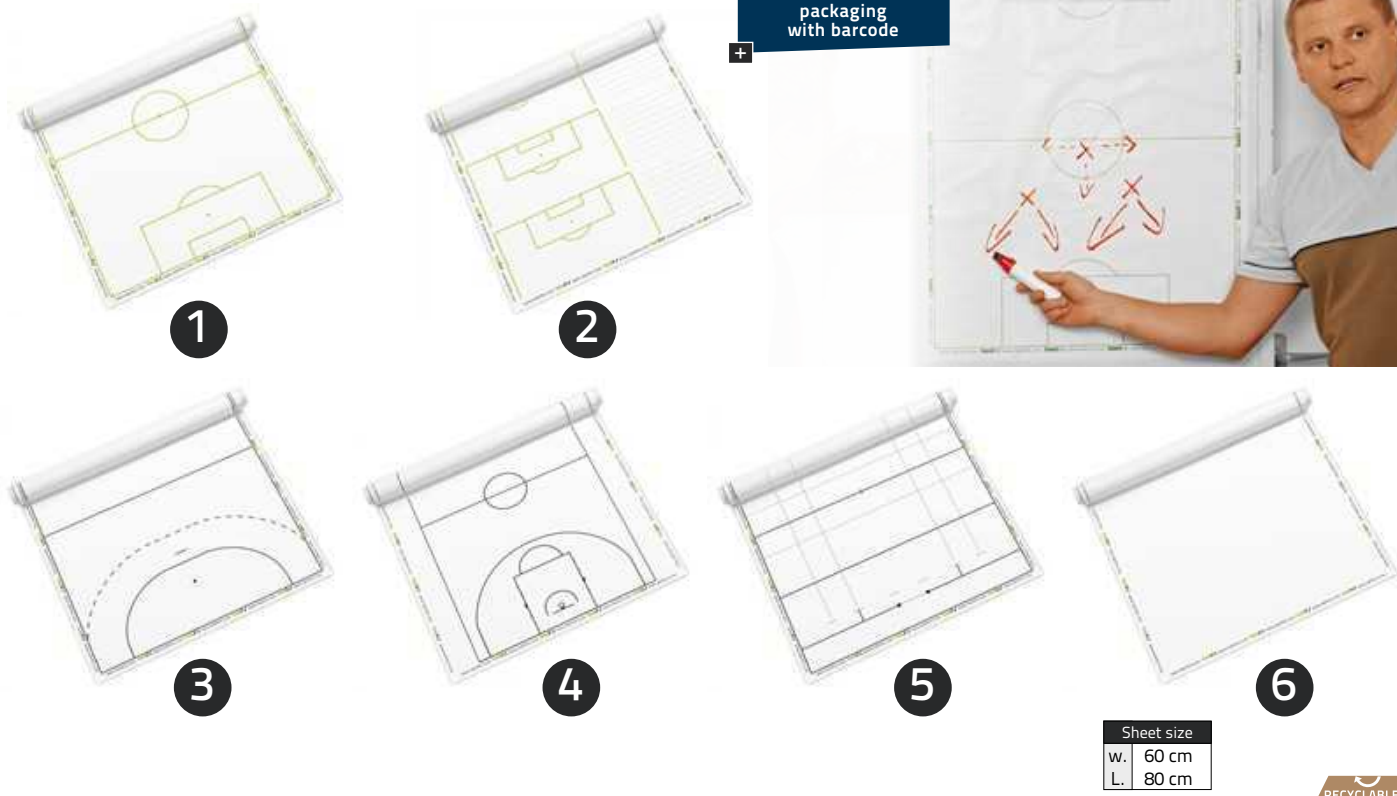

Practical use, easy to carry, the Taktifol can be used on any smooth surface (window, cloakroom door, wall, etc.). Dry-erasable and reusable. Roller of 60 cm in width and 20 m in length composed of 25 detachable pages. Exist in FOOTBALL, HANDBALL/FUTSAL, BASKETBALL, RUGBY and UNIVERSAL version. Delivered without carrying bag and pen.

- Reference: 063293 **1** FOOTBALL
- Reference: 063299 **2** FOOTBALL/PENALTY AREA
- Reference: 063294 **3** HANDBALL/FUTSAL
- Reference: 063295 **4** BASKET
- Reference: 063296 **5** RUGBY
- Reference: 063297 **6** UNIVERSAL

ACCESSORIES



Carrying bag with side pockets to store your accessories, cleaning cloth and set of 2 pencils.

- Reference: 063301 **1** Set of two pencils (1 Red / 1 Black)
- Reference: 063305 **2** Carrying bag and cleaning cloth
- Reference: 063472 **3** Football notepad

TAKTI-FOOT KIT



Composed of a roll of 25 Taktifol football sheets + 2 pencils (1 red and 1 black) + 1 notepad + 1 cleaning cloth + a suitable carrying bag.

Reference: 063470 Football kit

Sports bags, storage and transport
 Multisports
 Tracing and ground accessories
 Coach, referee and player
 First-aid
 Fitness, bodybuilding and gym
 Swimming
 Combat sports
 Racket sports
 Athletics
 Balls
 School
 Nets and accessories

PARTNER OF YOUR EDUCATORS!



LCD COACHING TABLET 16"



FOOTBALL



HANDBALL / FUTSAL



BASKETBALL



VOLLEYBALL

2026 NEW Available at the end of March 2026

16" size
w. 23.5 cm
L. 33 cm

RECYCLABLE

Tablet with 2 LCD screen functions. Locking and unlocking of the screen. Instant-erase. With dry-erase whiteboard on the back. Supplied with a magnetic stylus and an erasable pen. To charge the tablet, use a DC 5V charger not supplied, with a type C standard USB cable included.

Reference: 063037	FOOTBALL	16" / 33 x 23.5 cm
Reference: 063036	BASKETBALL	16" / 33 x 23.5 cm
Reference: 063038	HANDBALL / FUTSAL	16" / 33 x 23.5 cm
Reference: 063043	VOLLEYBALL	16" / 33 x 23.5 cm

LCD COACHING TABLET 16" KIT



Available in 5 sports

16" size
w. 23.5 cm
L. 33 cm

RECYCLABLE

Set composed of a LCD tablet 16", a 16" tablet bag, a magnetic writing stylus, an erasable pen and a type-C standard USB cable.

Reference: 063049	FOOTBALL
Reference: 063048	BASKETBALL
Reference: 063050	HANDBALL / FUTSAL
Reference: 063056	VOLLEYBALL

16" LCD TABLET BAG



LENGTH	WIDTH
27 cm	36 cm

Bag for carrying and protecting your LCD tablets. Material: polyester 420D.

Reference: 063045	16" LCD tablet bag
-------------------	--------------------

STYLUS FOR LCD TABLET



Magnetic stylus

RECYCLABLE

Stylus designed to be used with all LCD tablets versions.

Reference: 063019



PARTNER OF YOUR EDUCATORS!

LARGE 21" MODEL



LCD COACHING TABLET 21"



21" size
w. 30.6 cm
L. 45.5 cm



FOOTBALL



HANDBALL / FUTSAL



BASKETBALL

RECYCLABLE

Tablet with 2 LCD screen functions. Locking and unlocking of the screen. Instant-erase. With dry-erase whiteboard on the back. Supplied with a magnetic stylus and an erasable pen. To charge the tablet, use a DC 5V charger not supplied, with a type C standard USB cable included.

Reference: 063040	FOOTBALL	21" / 45.5 x 30.6 cm
Reference: 063039	BASKETBALL	21" / 45.5 x 30.6 cm
Reference: 063041	HANDBALL / FUTSAL	21" / 45.5 x 30.6 cm

LCD COACHING TABLET 21" KIT

21" size
w. 30.6 cm
L. 45.5 cm



Available in 4 sports

RECYCLABLE

Set composed of a LCD tablet 21", a 21" tablet bag, a magnetic writing stylus, an erasable pen and a type-C standard USB cable.

Reference: 063052	FOOTBALL
Reference: 063051	BASKETBALL
Reference: 063055	HANDBALL / FUTSAL

21" LCD TABLET BAG



RECYCLABLE
LENGTH 33 cm
WIDTH 48 cm

Bag for carrying and protecting your LCD tablets. Material: polyester 420D.

Reference: 063046

STYLUS FOR LCD TABLET



Magnetic stylus

RECYCLABLE

Stylus designed to be used with all LCD tablets versions.

Reference: 063019

Sports bags, storage and transport
Multisports
Tracing and ground accessories
Coach, referee and player
First aid
Fitness, bodybuilding and gym
Swimming
Combat sports
Racket sports
Athletics
Balls
School
Nets and accessories

+ Rigid wall tactical boards: magnetic and erasable

TWO-SIDED FOOTBALL SMALL BOARD 30 X 45 CM

SPORTI



+ A half football pitch on the back

LENGTH 45 cm WIDTH 30 cm



Wall tactical board, rigid, with on one side a whole football pitch and on the other side a half-pitch. Delivered with a carrying bag, magnets (11 blue, 11 red and 1 black), a brush, a felt pen and a sachet.

Reference: 063253 Unit

TWO-SIDED FOOTBALL LARGE BOARD 60 X 90 CM

SPORTI



+ A half football pitch on the back

LENGTH 90 cm WIDTH 60 cm



Wall tactical board, rigid, with on one side a whole football pitch and on the other side a half-pitch. Delivered with a carrying bag, magnets (12 blue, 12 red and 1 black), a brush, a felt pen and a sachet.

Reference: 063437 Unit

SMALL DOUBLE-SIDED BOARD HAND / FUTSAL 30 X 45 CM

SPORTI



+ A half handball pitch on the back

LENGTH 45 cm WIDTH 30 cm



Rigid tactical board, with on one side a whole handball pitch and on the other side a half-pitch. Delivered with its carrying bag, its magnets (10 blue, 10 red and 1 black), a brush, a felt pen and a sachet.

Reference: 063447 Unit

LARGE DOUBLE-SIDED BOARD HAND / FUTSAL 60 X 90 CM

SPORTI



+ A half handball pitch on the back

LENGTH 90 cm WIDTH 60 cm



Rigid tactical board, with on one side a whole handball pitch and on the other side a half-pitch. Delivered with its carrying bag, its magnets (7 blue, 7 red and 1 black), a brush, a felt pen and a sachet.

Reference: 063443 Unit

TWO-SIDED BASKETBALL SMALL BOARD 30 X 45 CM

SPORTI



+ A half basketball pitch on the back

LENGTH 45 cm WIDTH 30 cm



Rigid tactical board, with on one side a whole basketball pitch and on the other side a half-pitch. Delivered with its carrying bag, its magnets (8 blue, 8 red and 1 black), a brush, a felt pen and a sachet.

Reference: 063446 Unit

BASKETBALL TACTIC BOARD 60 X 90 CM

SPORTI



+ A half basketball pitch on the back

LENGTH 90 cm WIDTH 60 cm



Tactical board with its magnets (10 blue, 10 red, 1 yellow and 1 black) erasable felt pen and an eraser.

Reference: 063360 Unit

FOLDABLE MAGNETIC BOARD



+ 2 available sizes



Unfolded view



Folded size		Unfolded size	
w.	60 cm	w.	120 cm
L.	90 cm	L.	90 cm



Board easy to use, transportable thanks to its handle. Delivered without magnetic pawn.

Reference: 063445A 45 x 60 cm
Reference: 063445B 60 x 90 cm

TRIPOD FOR BOARD



Aluminium tripod for supporting your tactical boards. It adapts to different board sizes with a maximum height of 80cm, and its adjustable legs make it easy to set up. With its compact storage bag, it is the ideal companion for when you are on the move.

Reference: 063491 Unit

WHITE TACTIC BOARD



LENGTH	WIDTH
90 cm	60 cm

Blank rigid tactic board. Support base to put your pencils, magnets, etc. is included. Delivered without accessories.

Reference: 063210 Unit

PIVOTABLE WHITEBOARD ON WHEELS



DEPTH	WIDTH	H
55 cm	126 cm	17

Double-sided pivotable whiteboard on wheels with brake. Easy to move to set up your meeting rooms or club houses. This whiteboard pivots and holds in place thanks to a clip system. The writing surface is magnetic and dry erasable. It is fitted with a marker holder over the length.

Reference: 063490 Unit

POSTER SUPPORT



internal Ø
25 mm



Transparent poster support to facilitate your communication both outside and inside. You will slide your A4 papers in two seconds thanks to a clips system. You can fix it very quickly on any pole or slalom pole.

Ref: 063408 Set of 5 supports

Ref: 063403 The kit (5 supports + 5 yellow Poles of 160 cm + 5 rigid bases)

WHITE CLIPBOARD CLEANER



VOLUME 200 ml

Product specially designed for the regular maintenance of white boards, screens, laminated surfaces, mobile phones and so on. It removes the permanent felt-tips marks. Without fragrance.

Reference: 063343 Unit

MAGNETIC PAWN



DIAMETER 2 cm

Available in Red, Blue and Black.

Reference: 063444 Unit

SINGLE CARRYING BAG



Format 60x90cm compatible with: 063437, 063443, 063360.



Format 30x45cm compatible with ref: 063253, 063446 and 063447.



Reference: 063244 For board 30 x 45 cm

Reference: 063239 For board 60 x 90 cm

Sports bags, storage and transport
Multisports
Tracing and ground accessories
Coach, referee and player
First aid
Fitness, bodybuilding and gym
Swimming
Combat sports
Racket sports
Athletics
Balls
School
Nets and accessories

VERTICAL PUMP WITHOUT PRESSURE GAUGE



Vertical pump in resistant PVC with stable base. Delivered with needle.

Reference: 063074

VERTICAL PUMP WITH PRESSURE GAUGE



Vertical pump in resistant PVC with pressure gauge and stable base. Delivered with needle.

Reference: 063076 Unit

DOUBLE ACTION PUMP



HEIGHT 50 cm

Double action system, it inflates twice faster, recommended for the inflation of large balls like gym ball. Delivered with different nozzles.

Reference: 044074 Unit

HAND PUMP



Supplied with hose and a needle for balls.

Reference: 063269

DOUBLE ACTION HAND PUMP



Supplied with a hose and a needle for balls. Pump in both directions for a faster inflation.

Reference: 063270

PRESSURE GAUGE



Stainless pressure gauge to control the pressure of your balls. Rubber shock protection and decompression system with a push-button. Graduation with pressure indicator perfect per sport.

Reference: 063010

SET OF 3 NEEDLES IN A BLISTER PACK



European Model



Reference: 062982

SET OF 12 STEEL NEEDLE FOR BALLS



European Model



Reference: 062993

SET OF 50 NEEDLES FOR BALLS + 5 NOZZLES



European Model



Reference: 062991

NOZZLE



Nozzle to adapt a needle on its pump.

Reference: 063012

GLYCERIN



VOLUME 20 ml

Colourless, viscous solution; apply one drop to the needle so as not to damage the valve.

Reference: 063009

SPRAY TO REPAIR TYRE AND BALL



VOLUME 300 ml

Liquid to plug balls or tyres with or without an inner tube. Repair and instantly inflate again.

Reference: 063008

• TANK COMPRESSOR MECAFER



WEIGHT	LENGTH	WIDTH	HEIGHT
10.5 kg	34 cm	32 cm	36 cm

Portable compressor with 6 L tank and pressure up to 8 bars. Compact and light, it comes with a 5 m spiral hose, an inflation gun with pressure gauge and inflation accessory. Power supply: 220 V.

Reference: 064502 Unit

• PORTABLE COMPRESSOR MECAFER



WEIGHT	LENGTH	WIDTH	HEIGHT
6.5 kg	38 cm	14 cm	39.5 cm

Portable professional mini-compressor with a power of 1100 W. With its 8 bars of pressure, it releases up to 160 L/min. Sold with all the tips allowing you varied uses. Equipped with a quick connector, it comes with a pressure gauge gun. Its weight, dimensions and handle allow it to be moved easily.

Reference: 064501 Unit

COMPRESSOR



WEIGHT	LENGTH	WIDTH	HEIGHT
3.7 kg	25.5 cm	13.5 cm	20.5 cm

Electric compressor with integrated pressure gauge, on / off switch, pressure regulator and air filter. Delivered with its hose and its inflation nozzles. Power supply: 220 - 240 V / 50 Hz. Maximum pressure: 4 Bars.

Reference: 063137 Unit

• WIRELESS COMPRESSOR



Ultra light!

WEIGHT	LENGTH	WIDTH	HEIGHT
330 g	13 cm	4 cm	8 cm

Light and compact, it fits in the palm of your hand and becomes the ideal partner for your bike rides or your outdoor training. Comes with a ball pump needle and adapter. Max pressure 7.5 bar. 2200 mAh high capacity rechargeable Li-ion battery.

Reference: 063015

WIRELESS MULTI-USE COMPRESSOR



RECYCLED RECYCLABLE

Wireless multi-use compressor, it is suitable for an effective inflation of balls, adjustment and reading of the pressure in Psi or Bar. It works with battery (9.6 V - 10 Bars pressure) or can be directly connected on the cigarette lighter of a car (12 V). Power: 180 W. Battery: 11.1 V. Supplied with ball and bike adapters.

Reference: 063007

Sports bags, storage and transport
 Multisports
 Tracing and ground accessories
 Coach, referee and player
 First aid
 Fitness, bodybuilding and gym
 Swimming
 Combat sports
 Racket sports
 Athletics
 Balls
 School
 Nets and accessories

ARMBANDS

«C» ARMBAND

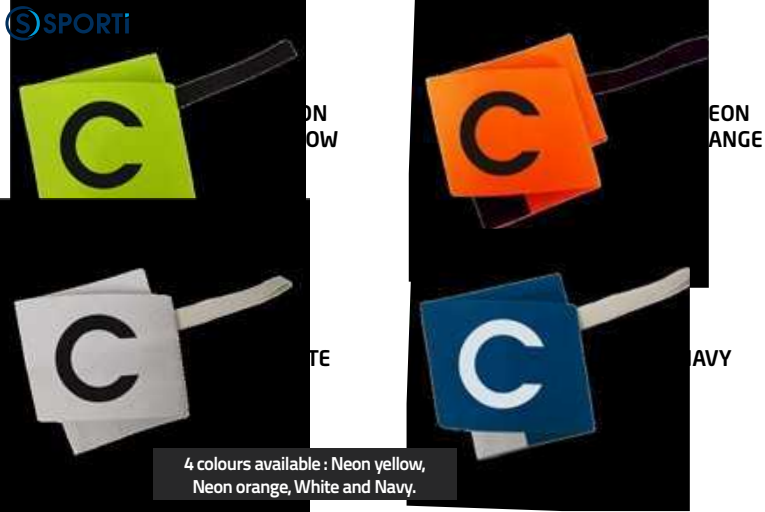

4 colours available: Neon yellow, Neon orange, White and Navy.



+ All our armbands are supplied in individual packaging easy to put on shelves



WIDTH 9 cm LENGTH 35 cm

With elastic and large hook and loop to increase comfort.

Reference: 063255

Unit

REVERSIBLE ARMBAND

SPORTi



+ 1 armband = 2 possibilities!



WIDTH 9 cm LENGTH 35 cm

Reversible armband. With large hook and loop to increase comfort.

Reference: 063225

Unit

CLASSIC CAPTAIN ARMBAND

SPORTi



WIDTH 4 cm

With elastic and large hook and loop to increase comfort.

Reference: 063224

Unit

ELASTIC CAPTAIN ARMBAND

SPORTi



WIDTH 8 cm

2 colours available (Red / White and Blue / White).

Reference: 063254J

Junior

Reference: 063254S

Senior

+ All our armbands are supplied in individual packaging easy to put on shelves

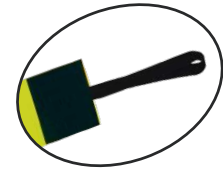

WIDTH 9 cm LENGTH 35 cm

With elastic and large hook and loop to increase comfort.

Reference: 063102	SPORTS MANAGER ARMBAND
Reference: 063258	DELEGATE
Reference: 063259	ORGANISATION
Reference: 063260	TRAINER
Reference: 063261	ASSISTANT
Reference: 063262	HEALER
Reference: 063263	MEDICAL STAFF
Reference: 063264	SECURITY
Reference: 063240	PHYSICAL TRAINER

MOURNING ARMBAND
SPORTi



PLAIN ARMBAND
SPORTi



WIDTH 9 cm LENGTH 35 cm

With elastic and large hook and loop fastener to increase comfort.

Reference: 063257	Unit	WIDTH 5 cm	Reference: 063266	White
			Reference: 063266	Neon orange
			Reference: 063266	Neon yellow

Sports bags, storage and transport
Multisports
Tracing and ground accessories
Coach, referee and player
First-aid
Fitness, bodybuilding and gym
Swimming
Combat sports
Racket sports
Athletics
Balls
School
Nets and accessories

ODOMETER



CARRYING BAG

+ Retractable

RECYCLABLE

WEIGHT
2 kg

Unfolded
L. 102 cm
Folded
L. 55 cm
Wheel
∅ 31.8 cm

Foldable to facilitate the storage. Delivered with a carry bag. Features: measuring range from 0 to 99.999.9 m, resolution 0.1 m.

Reference: 024078

Unit

MEASURE TAPE



30 M



50 M



100 M

RECYCLABLE

Thermoplastic box with tape measure in fibreglass with centimetre and inch graduation.

Reference: 062737	10 m.
Reference: 062745	20 m.
Reference: 024051	30 m.
Reference: 024052	50 m.
Reference: 024053	100 m.

MEGAPHONE



WEIGHT	DIAMETER	LENGTH
1.2 kg	20.5 cm	34 cm

RECYCLABLE

Made in ABS, sturdy yet light weight. Clear sound, long range (500 m) and efficient design. Conveniently located volume control and switch. Power output: 30 W. Power source: 6 x «C» cells (not included). Horn diameter 20.5 cm. Weight (without cell): 1.2 kg.

Reference: 024048

MANUAL PULSE METER



RECYCLABLE

Chromed metal case, 4 numbers of 47 x 25 mm, with reset function.

Reference: 024055

Unit

PLASTIC WHISTLE + LANYARD



Reference: 063193

Unit

BOX OF 12 PLASTIC WHISTLES



Reference: 062739

Box of 12

STEEL WHISTLE + LANYARD



Reference: 063194

Unit

BOX OF 12 STEEL WHISTLES



Reference: 062740

Box of 12

HAND WHISTLE



The reference of hand whistles



Hand whistle, perfect for several users to maintain hygiene, effortlessly loud and strident sound. Available colours: red, blue, purple and orange.

Reference: 063153

Unit

SET OF 12 LANYARDS



Reference: 062738

Set of 12 wrist lanyards

Reference: 063182

Set of 12 neck lanyards

ELECTRONIC WHISTLE



Electronic whistle with manual control. This kind of article is voted in by physical education teachers because it is more hygienic. 2 different tones. Ergonomic design, light and robust. Delivered with cordon. Powered by 4 x LR44 batteries, not included. Decibel: max.110 DB.

Reference: 063485

Sports bags, storage and transport

Multisports

Tracing and ground accessories

Coach, referee and player

First aid

Fitness, bodybuilding and gym

Swimming

Combat sports

Racket sports

Athletics

Balls

School

Nets and accessories



WITHOUT LITTLE BALL TECHNOLOGY = SOUND NOT BLOCKED



WHISTLES DELIVERED UNDER PACKAGING



SHARX FOX WHISTLE



Whistle made for an outside use in extreme conditions including water sports. Powerful sound of 120 dB, clear and easily identifiable even in difficult environments. Made without ball avoiding the risks of blockage, Delivered with a neck cord. 2 available colours: Black/Black and Orange/Blue.

Reference: 063140

Unit

PEARL FOX WHISTLE



Whistle without ball ideal in a school environment or for multi-ground games. Less powerful (90 dB) it has a very distinct and easily recognizable sound and very audible despite ambient noise. Ideal for a whistle use as a second tone when it's associated to the classic whistle. Delivered with an elastic wrist cord. 4 available colors: Blue, Neon yellow, Black and Red.

Reference: 063139

Unit

FOX REFEREE PACK



Pack consisting of a 'CLASSIC' whistle (115dB) + a 'SONIK CMG' whistle (120 dB) + a 'PEARL' whistle (90 dB) + a PILE or FACE coin + a safety cord. All components are stored in a durable and convenient zippered nylon carrying case.

Reference: 063151

• FOX ELECTRONIC WHISTLE



FOX electronic whistle with manual control which guarantees a better hygiene. The sound can go toward the desired direction (effective and reassuring), 3 different tones. Works with a 9 V battery (including - type 6F22). Power: 100 dB.

Reference: 063369

Unit

FOX SAFETY LANYARD

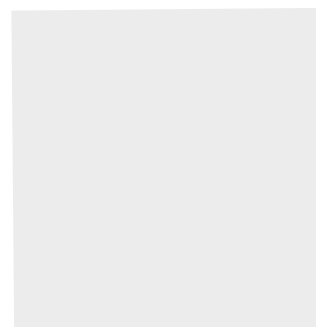

Black colour. Sold without whistle.

Reference: 063090

Unit

Sports bags, storage and transport
Multisports
Tracing and ground accessories
Coach, referee and player
First aid
Fitness, bodybuilding and gym
Swimming
Combat sports
Racket sports
Athletics
Balls
School
Nets and accessories

FOX CLASSIC WHISTLE

THE market reference +



WHITE

RED

PURPLE

BLUE

YELLOW

NEON GREEN

NEON ORANGE

NEON PINK

YELLOW

Whistle without little ball. Power: 115 dB.

Reference: 063088

Unit



FOX CLASSIQUE MINI



Smaller = less powerful = better indoor +

FOX whistle classic mini, with the same design than the large model, it makes a sound less powerful due to its smaller chamber. Perfect for indoor sports. Power: 109 dB.

Reference: 063366

Unit



FOX WHISTLE SONIK CMG®



Overpowered +

The most performing of superpowerful whistles, to use only outdoor, with a multidirectional sound 120 dB, without whistling, stable, regulated and very clear. It never get stuck and works in all weathers.

Reference: 063367

Unit



FOX WHISTLE WITH FINGER CLIP



Already adopted by many professionals, this technology allows excellent handling of the whistle due to ergonomics and pleasant materials. The fact that the whistle can be removed and put back on its magnetic base, will offers great freedom of movement. Device equipped with the "CLASSIC" whistle.

Reference: 063152

Unit

FOX CLASSIC CMG® WHISTLE



FOX whistle with connector. Same design than FOX classic large having a flexible connector for an easier catch in mouth. Power: 115 dB.

Reference: 063136

Unit

FOX FUZIUN® WHISTLE



Ultra powerful whistle designed in 3 chambers allowing an optimal sound. Ergonomic design and soft tip for a perfect grip. Power: 118 dB.

Reference: 063216

Unit

Sports bags, storage and transport

Multisports

Tracing and ground accessories

Coach, referee and player

First-aid

Fitness, bodybuilding and gym

Swimming

Combat sports

Racket sports

Athletics

Balls

School

Nets and accessories

• DOUBLE-SIDED SUBSTITUTION BOARD



Mode player substitution and additional time

LENGTH	HEIGHT	WEIGHT
55 cm	26 cm	2.6 kg

Double-sided player substitution board with LED lights. Offers 2 operating modes: player substitution with incoming and outgoing numbers from 0 to 99, or additional time from 0 to 99 minutes. High visibility (120 m) with digits measuring 18 x 10 cm. Can also be used as a scoreboard. Lithium battery, supplied with charger. Battery life: 5 hours of use.

Reference: 068003 Unit

• ELECTRONIC SCOREBOARD DISPLAY / PLAYER SUBSTITUTION



LENGTH	HEIGHT	WEIGHT
55 cm	26 cm	2 kg

Single-sided LED player-change panel. 2 modes : either player changeover with in/outcoming numbers (from 0 to 99), or additional time from 0 to 9 min. High visibility (120 m) - Digit size = 18 x 10cm. Can be used as a scoreboard. Lithium battery, delivered with charger. Autonomy: 5 hours.

Reference: 068001N Unit

STOPWATCH WATCH



RECYCLED RECYCLABLE

1 timing line - Accuracy 1/100 sec - Timing time: 24H 12-24H clock / alarm / date mode - Countdown timer mode - Backlighting of the screen - Splash proof - Dial diameter 50mm - Digit height: 10/4 mm . - 63 gr.

Reference: 024001 Unit

MANUAL PLAYER CHANGE SYSTEM



The set		1 number	
L.	40 cm	L.	14 cm
H.	31 cm	H.	27 cm

Two-sides player change system. Numbering from 0 to 99 on each face thanks to reversible black/yellow or black/orange pallets. Neon color for high visibility.

Reference: 062797 Unit

REFEREE WATCH



2026 NEW Available in March 2026

Stopwatch watch combining ease of use and numerous features: stopwatch mode, countdown timer, alarm (dual), simple time display. With backlight and energy-saving mode. CR2032 battery included.

Reference: 024009 Unit

REFEREE BAG



Bag	
H.	19.5 cm
L.	15.5 cm

It includes 1 red card - 1 yellow card - 1 white card - 1 notebook of 15 football scorecards - 1 notebook - 1 whistle with lanyard - 1 whistle - 1 two-sided piece - 1 wood pencil - 1 ballpoint - in a bag with several compartments and a zip.

Reference: 063292 Unit

PLAIN LINESMAN FLAG



PVC handle with a flag delivered with a carrying bag. Sold per pair.

Reference: 063126 Pair

CHEQUERED LINESMAN FLAG



PVC handle with a flag delivered with a carrying bag. Sold per pair.

Reference: 063095 Pair

MULTI-CHEQUERED LINESMAN FLAG



PVC handle with a flag delivered with a carrying bag. Sold per pair.

Reference: 063095A Pair

• ELECTRONIC LINESMAN FLAG KIT

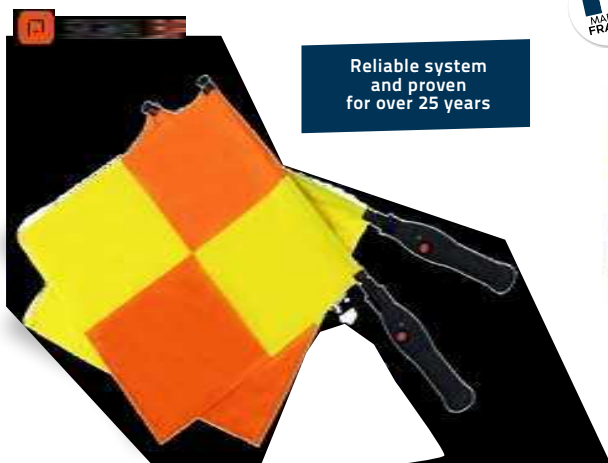

Reliable system and proven for over 25 years



Comes with the hard shell bag allowing you to transport everything the safety kit

- Kit for 3 referees consisting of:
- 2 flags for assistant referees
 - 1 receiver for the central referee
 - 1 cuff pouch
 - 1 multi-wire cable for charging
 - 1 USB adapter
 - 1 hard shell bag
 - 1 multilingual notice



Long range radio transmission. Battery life of 20 hours. Volume and vibrator adjustment on the armband box in 5 levels + OFF mode. Automatic flag standby. Vibrator and buzzer integrated into the flags. Charger supplied with 3-connector USB adapter for simultaneous charging of the flags and the armband box.

Reference: 063214

With ORANGE sleeves

Reference: 063214

With BLACK sleeves

REFEREE CARDS



LENGTH 11.2 cm
WIDTH 7.7 cm

Referee cards available in 3 different colours.

Reference: 063265 Yellow, Red, White or Blue

Reference: 063190 Orange

REFEREE PIECE



Piece heads or tails. Colour: Black / White.

Reference: 063307 Unit

FOOTBALL REFEREE WALLET AND SET OF SCORECARDS



This set contains 3 cards (1 red, 1 yellow and 1 white), a notebook of 15 scorecards and one pencil.

Reference: 063223 ① Set

Reference: 063277 ② Set of 15 scorecards

HANDBALL REFEREE WALLET AND SET OF SCORECARDS



This set contains 3 cards (1 red, 1 yellow and 1 white), a notebook of 15 scorecards and one pencil.

Reference: 063222 ① Set

Reference: 063278 ② Set of 10 scorecards



Sports bags, storage and transport
Multisports
Tracing and ground accessories
Coach, referee and player
First aid
Fitness, bodybuilding and gym
Swimming
Combat sports
Racket sports
Athletics
Balls
School
Nets and accessories

MULTISPORTS SCORER



Folded	
L.	49 cm
H.	28 cm

Foldable multi-sports scorer, composed of 2 numbers from 0 to 99, one number from 1 to 4 and arrows to know the way of the game.

Reference: 062741 Unit

MARKER «ARROW»

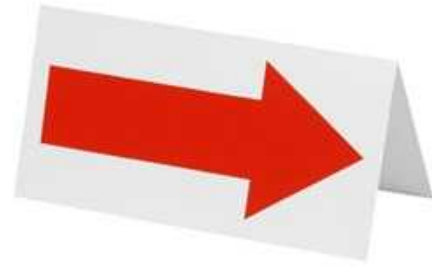

This arrow marker is used to indicate the way of the game or the tour, in PVC (polyvinyl chloride). Visual face 20 x 10 cm.

Reference: 063111 Unit

FOUL MARKERS PAIR OF TEAM FOULS

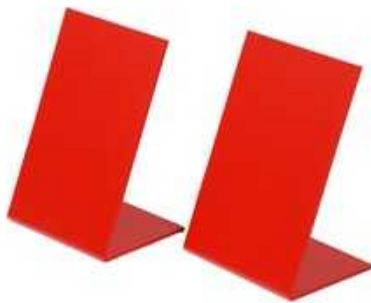

Foul markers pair of team fouls, in PVC (polyvinyl chloride). Large visual 21 x 15 cm allowing an excellent visibility. Very stable.

Reference: 063112 Pair

SET OF 5 FOUL MARKERS

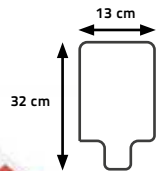

Required foul markers in flexible plastic, printed both sides. Numbers from 1 to 4 in black and number 5 in red.

Reference: 063110 Set of 5

HANDBALL TEAM TIME-OUT CARD



LENGTH	WIDTH
20 cm	15 cm

Set of 3 handball team time-out green cards numbered T1, T2 and T3. PP material, flexible and weather resistant.

Reference: 063221 Le lot de 3

GD BASKET MARKER



LENGTH	WIDTH
32 cm	25 cm

GD disqualification marker. This sixth foul marker is required for disqualifications after 2 unsporting or technical player fouls, or 2 'C' fouls or 3 'B' or 'C' fouls for a coach. Double-sided printing (white letter on a red background). Letters dimensions: 10 cm width x 20 cm height (compulsory dimensions).

Reference: 063206 Unit

Stopwatches and digital displays

Case for multiple stopwatches	84
Watches and student stopwatches	86
Competition stopwatches	87
Teacher stopwatches	88
Professional stopwatches and printers	90
SportBeeper	93
Displays	94

TO DISCOVER



P.87



P.93

FRONT/BACK



P.94



Founded in the 1980s, DIGI SPORT Instruments specialises in designing and manufacturing sports measurement equipment for athletics, swimming, basketball, water polo, football and many other sports. As a major supplier in professional timekeeping in France and Europe, **DIGI SPORT Instruments** is known for its reliability and robustness. Taken over in 2022, **SPORTIFRANCE** will continue to develop both stopwatch ranges: «Pro» and «Eco».

PRO RANGE:



The favorite brand for pros. Products that have already made a difference on all tracks for years.

ÉCO RANGE: **SPORTi**



Efficient and sturdy dedicated to schools and occasional use.

SCO SOFT CASES



X 16

KIT
1 SOFT CASE + INNER FOAM PROTECTION (024070)
+
16 DT481 STOPWATCHES (ON/OFF) (024017B - P.86)
REF: 024130



X 24

KIT
1 SOFT CASE + INNER FOAM PROTECTION (024070)
+
24 SCO STOPWATCHES (024017B - P.86)
REF: 024131

DT481 (ON/OFF) SOFT CASES

ON / OFF Button



X 16

KIT
1 SOFT CASE + INNER FOAM PROTECTION (024070)
+
16 DT481 STOPWATCHES (ON/OFF) (024139 - P.86)
REF: 024005



X 24

KIT
1 SOFT CASE + INNER FOAM PROTECTION (024070)
+
24 DT481 STOPWATCHES (ON/OFF) (024139 - P.86)
REF: 024006

DT1 SOFT CASES



X 16

KIT
1 SOFT CASE + INNER FOAM PROTECTION (024070)
+
16 DT1 STOPWATCHES (024100 - P.86)
REF: 024132



X 24

KIT
1 SOFT CASE + INNER FOAM PROTECTION (024070)
+
24 DT1 STOPWATCHES (024100 - P.86)
REF: 024133

CASE FOR MULTIPLE STOPWATCHES

• HARD CASE



Easy and stiff opening



LENGTH 33 cm
WIDTH 24 cm
HEIGHT 8 cm

Hard red plastic case inner structured foam for stopwatch protection and storage.

Reference: 024028 Case + foam
Reference: 024025 Case only

SOFT CASE



LENGTH 37 cm
WIDTH 30 cm

Case with removable foam.

Reference: 024070 Case + foam

SCO HARD CASES



KIT

1 HARD CASE + INNER FOAM PROTECTION (024028)
+
16 SCO STOPWATCHES (024017B - P.86)

REF: 024021



KIT

1 HARD CASE + INNER FOAM PROTECTION (024028)
+
24 SCO STOPWATCHES (024017B - P.86)

REF: 024023

DT481 (ON/OFF) HARD CASES

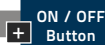

KIT

1 HARD CASE + INNER FOAM PROTECTION (024028)
+
16 DT481 STOPWATCHES (ON/OFF) (024139 - P.86)

REF: 024003



KIT

1 HARD CASE + INNER FOAM PROTECTION (024028)
+
24 DT481 STOPWATCHES (ON/OFF) (024139 - P.86)

REF: 024004

DT1 HARD CASES



KIT

1 HARD CASE + INNER FOAM PROTECTION (024028)
+
16 DT1 STOPWATCHES (024100 - P.86)

REF: 024127



KIT

1 HARD CASE + INNER FOAM PROTECTION (024028)
+
24 DT1 STOPWATCHES (024100 - P.86)

REF: 024128



Sports bags, storage and transport
Multisports
Tracing and ground accessories
Coach, referee and player
Stopwatches and digital displays
First aid
Fitness and combat
Swimming
Racket sports
Athletics
Balls
School
Nets and accessories

WATCHES AND STUDENT STOPWATCHES

REFEREE WATCH



2026 NEW Available mid-March

STOPWATCH WATCH



Stopwatch watch combining ease of use and numerous features: stopwatch mode, countdown timer, alarm (dual), simple time display. With backlight and energy-saving mode. CR2032 battery included.

1 timing line - Accuracy 1/100 sec - Timing time: 24H 12-24H clock / alarm / date mode - Countdown timer mode - Backlighting of the screen - Splash proof - Dial diameter 50 mm - Digit height: 10/4 mm - 63 g.

Reference: 024009

Unit

Reference: 024001

Unit

SCHOOL: STUDENT



12 mm



SCO Ref: 024017B



ON / OFF Button

17.5 / 15.5 mm



DT481 Ref: 024139



8 mm



DT1 Ref: 024100



8 mm



DT2N Ref: 024101

	SCO	DT481 (ON/OFF)	DT1	DT2N
Rows	1	1	1	1
Memory	-	-	-	-
Precision timer	1/100sec	1/100sec	1/100sec for 30 minutes, then 1/1.	1/100sec for 60 minutes, then 1/1.
Record time	24h	10h	24h	24h
Time / calendar / alarm	✓/✓/✓	-	✓/✓/✓	✓/✓/✓
Pace function	-	-	-	-
Countdown timer	-	-	-	-
Lap / split option	-/✓	✓/✓	-/✓	-/✓
Stroke option	-	-	-	-
Fastest / slowest timer	-	-	-	-
Average time / split - lap	-	-	-	-
Backlighting	-	-	-	-
Continuons display of time and results during timing	-	-	-	-
Water-resistance	-	✓	✓	✓
Dimensions (mm)	83 X 62 X 23 mm	78 X 61 X 23 mm	68 X 60 X 15 mm	75 X 66 X 20 mm
Screen size (mm)	35 X 17 mm	37 x 15	~28 mm Ø	35 X 14 mm
Digits	6	7	6	6
Digits size (mm)	12	17.5/15.5	8	8
Weight	44gr.	58gr	63gr.	68gr.
Batteries	LR44	CR2032	LR44	CR2032
Blister pack	✓	✓	✓	✓
	Reference: 024017B	Reference: 024139	Reference: 024100	Reference: 024101

COMPETITION



“QUICK INFO

DUAL PROGRAMMING TIMER

Allows sequences of 2 consecutive timers.

Example: A split training running session with a running time (1st timer) and a rest time (2nd timer).



	30 MEMORIES	60 MEMORIES	C100
Rows	3	3	3
Memory	30	60	100
Precision timer	1/100sec	1/100sec	1/100sec
Record time	10h	10h	10h
Time / calendar / alarm	✓/✓/✓	✓/✓/✓	✓/✓/✓
Pace function	From 10 to 320/min	From 10 to 320/min	From 10 to 320/min
Countdown timer	Programmable Time signal Sequence counter	Programmable Time signal Sequence counter	Dual programming (working timer/rest timer) Time signal Sequence counter
Lap / split option	✓/✓	✓/✓	✓/✓
Stroke option	-	-	✓ (base 3)
Fastest / slowest timer	✓	✓	✓
Average time / split - lap	✓	✓	✓
Backlighting	✓	✓	✓
Continuons display of time and results during timing	✓	✓	✓
Water-resistance	✓	✓	✓
Dimensions (mm)	84 X 63 X 30 mm	68 X 63 X 30 mm	87 X 60 x 18 mm
Screen size (mm)	38 X 22 mm	38 X 22 mm	42 X 32 mm
Digits	23	23	24
Digits size (mm)	5 / 5 / 6	5 / 5 / 6	10 / 7 / 7
Weight	67 gr.	67 gr.	80 gr.
Batteries	CR2032	CR2032	CR2032
Blister pack	✓	✓	-
	Reference: 024063	Reference: 024079	Reference: 024019



Sports bags, storage and transport

Multisports

Tracing and ground accessories

Coach, referee and player

Stopwatches and digital displays

First aid

Fitness and combat

Swimming

Racket sports

Athletics

Balls

School

Nets and accessories

SCHOOL: TEACHER



DT280 Ref: 024103



DT480 Ref: 024104

“QUICK INFO

SPLIT = The time taken to complete a recognized part of a race, or the point in the race where such a time is measured.

LAP = the time taken to complete the race ie: An athlete completes 3 laps of the track.

Ex : He completes the first lap in 1min, the second in 1m30sec and the 3rd in 1m15sec

Time	SPLIT	LAP
Starting	-	-
End of 1st race:	00:01:00	00:01:00
End of 2nd race:	00:02:30	00:01:30
End of 3rd race:	00:03:45	00:01:15



DTM64 Ref: 024002

	DT280	DTM64	DT480
Rows	2	2	2
Memory	8	30	50
Precision timer	1/100sec	1/100sec	1/100sec
Record time	10h	10h	10h
Time / calendar / alarm	- / - / -	- / - / -	- / - / -
Pace function	From 2 to 600/min	-	From 2 to 600/min
Countdown timer	Programmable Time signal Sequence counter	Programmable Time signal Sequence counter	Programmable Time signal Sequence counter
Lap / split option	✓/✓	✓/✓	✓/✓
Stroke option	-	-	-
Fastest / slowest timer	-	-	-
Average time / split - lap	-	-	-
Backlighting	-	-	-
Continuons display of time and results during timing	-	-	-
Water-resistance	✓	✓	✓
Dimensions (mm)	68 X 63 X 20 mm	80 X 62 X 22 mm	68 X 63 X 20 mm
Screen size (mm)	38 X 22 mm	32 X 23 mm	38 X 22 mm
Digits	15	15	15
Digits size (mm)	7.5 / 5	8 / 6	7.5 / 5
Weight	60gr.	55gr.	60gr.
Batteries	CR2032	CR2032	CR2032
Blister pack	✓	-	✓
	Reference: 024103	Reference: 024002	Reference: 024104



"QUICK INFO

STROKE = to time individual average number of movements per minute.
Example: To know the number of movements of a swimmer's arm over 1 minute.

"QUICK INFO

PACER
Possibility to produce a regular interval sound signal.
Ex: a signal is emitted every second to give the requested tempo.

	DTM60SEL	DTM60S	DT320	DTM60EL
Rows	3	3	3	3
Memory	60	60	300	300
Precision timer	1/100sec	1/100sec	1/100sec	1/100sec
Record time	10h	10h	10h	10h
Time / calendar / alarm	✓/✓/✓	✓/✓/✓	✓/✓/✓	✓/✓/✓
Pace function	From 1 to 60/min	From 1 to 60/min	From 2 to 600/min	From 1 to 60/min
Countdown timer	Dual programming (working timer/rest timer) Time signal Sequence counter	Dual programming (working timer/rest timer) Time signal Sequence counter	-	Dual programming (working timer/rest timer) Time signal Sequence counter
Lap / split option	✓/✓	✓/✓	✓/✓	✓/✓
Stroke option	-	-	✓ (base 3)	-
Fastest / slowest timer	✓	✓	✓	✓
Average time / split - lap	✓	✓	✓	✓
Backlighting	✓	-	-	✓
Continuons display of time and results during timing	✓	✓	✓	✓
Water-resistance	✓	✓	✓	✓
Dimensions (mm)	68 X 63 X 20 mm	68 X 63 X 20 mm	75 X 62 X 20 mm	68 X 63 X 20 mm
Screen size (mm)	38 X 22 mm	38 X 22 mm	38 X 22 mm	38 X 22 mm
Digits	23	23	24	24
Digits size (mm)	5 / 4 / 4	5 / 4 / 4	5 / 4 / 4	5 / 4 / 4
Weight	60gr.	60gr.	75gr.	60gr.
Batteries	CR2032	CR2032	CR2032	CR2032
Blister pack	✓	✓	✓	✓
	Reference: 024107	Reference: 024106	Reference: 024110	Reference: 024108

PROFESSIONAL STOPWATCHES

QUICK INFO

Data can be printed by an optional printer (024114) or downloaded to a PC via an optional cable (024126).

	DT500	DT2000
Rows	3	3
Memory	500	2000
Precision timer	1/100sec	1/100sec
Record time	10h	10h
Time / calendar / alarm	✓/✓/✓	✓/✓/✓
Pace function	From 1 to 60/min	From 1 to 60/min
Countdown timer	Dual programming (working timer/rest timer) Time signal Sequence counter	Dual programming (working timer/rest timer) Time signal Sequence counter
Lap / split option	✓/✓	✓/✓
Stroke option	✓	✓
Fastest / slowest timer	✓	✓
Average time / split - lap	Recallable memory	Recallable memory
Backlighting	non	non
Continuons display of time and results during timing	✓	✓
Water-resistance	✓	✓
Dimensions (mm)	77 X 59 X 20 mm	77 X 59 X 20 mm
Screen size (mm)	36 X 21mm	36 X 21 mm
Digits	24	25
Digits size (mm)	5 / 5 / 5	5 / 5 / 5
Weight	63gr.	63gr.
Batteries	CR2032	CR2032
Reference	Reference: 024111	Reference: 024112



DT500 Ref: 024111



DT2000 Ref: 024112

ACCESSORIES

DT5100P PRINTER



COMPATIBLE WITH: DT500 DT2000



Equipped with a thermal printing system, this compact and high-performance printer easily connects to the PRO DT500 (Ref. 024111) and DT2000 (Ref. 024112) thanks to the supplied data cable. Rechargeable lithium battery (recommended charger: 5V/1A or 5V/2A, not included). Dimensions: 17 x 8.5 x 4 cm / Weight: 180 g. Compatible with paper rolls Ref. 024138.

Reference: 024114N

Unit

DATA TRANSFER SOFTWARE FOR PC



COMPATIBLE WITH: DT500 DT2000



PC interface and software - Easy to use - data import to PC - Interface connection via USB port (USB/DB9 cable included) - Configuration with at least Windows 98.

Reference: 024113

Unit

REPLACEMENT CABLE FOR DT500P



COMPATIBLE WITH: DT500P



Replacement cable for DT500P (ref: 024114N)

Reference: 024126

Unit

SET OF PAPER ROLLS FOR PRINTER



Paper roll for printer DT500P (ref: 024114), DT8000 (ref: 024117), DT2500P (ref: 024115), DT8100 (ref: 024136), DT820 (ref: 024137) and DT5100P (ref: 024114N).

Reference: 024123 Set of 4 - for DT8000 and DT2500P

Reference: 024138 Set of 5 - for DT8100, DT820, DT5100P

Reference: 024122 Set of 5 - for DT500P

STOPWATCHES WITH PRINTER SYSTEM DT820



+ Thermal printer

“QUICK INFO

New version which replaces the DT2500P (ref 024115). Supplied with a USB drive for easier data transfer.

Features:

- 2000-lap memories
- Separate memory (possibility to store the time of each lap in different races)
- Possibility for the user to select return/time or return/speed display
- User selectable Return/Time or Return/Speed
- Display of average and best lap time
- Automatic publication of lap time after 10 seconds for progress monitoring
- Data print function during operation or selectively per race later (memory segregated by event)
- Data transfer to computer (wire supplied, optional software ref: 024113)

Timer:

- Double timer, the timers start with each other during training sessions
- Possibility to use traditional countdown timer if the 2nd timer is not set

Clock:

- Hours, minutes, seconds, month, date, day and alarm clock
- 12/24 hour and month/day or day/month



The data can be downloaded to a PC (optional software).



H. 3 cm
w. 8.5 cm
L. 17 cm

RECYCLABLE
WEIGHT
220 gr.

Supplied with a neck lanyard and 2 extra paper rolls (ref: 024138).

Reference: 024137

Unit

Reference: 024116

Spare PC cable for DT2500P and DT820

CLIP FOR STOPWATCH



H. 11 cm
w. 3 cm
L. 6.5 cm

RECYCLABLE
WEIGHT
9 gr.

Compatible with ref 024103, 024104, 024105, 024106, 024107, 024108.

Reference: 024125

Unit (without stopwatch)

BATTERIES



Sold by the unit.

Reference: 024058

LR44

Reference: 024081

CR2025

Reference: 024059

CR2032

POCKET FOR STOPWATCH



H. 10 cm
w. 3 cm
L. 9 cm

RECYCLABLE

Compatible with any DIGISPORT reference except stopwatches with printer systems.

Reference: 024124

Unit (without stopwatch)



Sports bags, storage and transport
Multisports
Tracing and ground accessories
Coach, referee and player
Stopwatches and digital displays
First aid
Fitness and combat
Swimming
Racket sports
Athletics
Balls
School
Nets and accessories

DT8100 STOPWATCH WITH PRINTER SYSTEM + DATA TRANSFER SOFTWARE



“QUICK INFO

New version which replaces the DT8000 (ref 024117). Supplied with an USB drive for easier data transfer.

Stopwatch:

- 8000-lap memories
- Integrated printer
- Up to 10 joystick buttons for lane selection
- Data transfer function on PC
- Bib number up to 4 digits (9999)
- 4-digit lap counter
- 2-digit time counter
- Automatic printing
- Printing the final result
- Maximum 10 departures
- Selective deletion of data in memory
- Sound button
- 12/24h format
- Real-time data recording
- Saving recordings and exporting files
- Rechargeable by standard USB charger with 5V USB output 2A or 3A (not included), with supplied USB/Type C cable
- Dimensions: 8.5 cm x 16.5 cm x 4 cm

H.	4 cm
w.	8.5 cm
L.	16.5 cm

Printer:

- Japanese thermal printing system
- Printing speed: 1.5 lines/sec
- 25 digits/line
- Power adapter supplied
- 2 extra rolls of paper supplied (ref : 024138)

DELIVERED WITH:

Logiciel et cabling : Software and wiring:

- Memory transfer
- In-real-time data recording
- Recording saved
- File export
- USB key with software

Linkgate:

- 1 hub
- 10 ports
- 3V CR2032 Lithium battery

1 3m wired handle

2 paper rolls - 024138

1 neck lanyard



WEIGHT
200g

Reference: 024136

Unit

WIRED HANDLE ASSEMBLING



WIRED HANDLE - 15M



COMPATIBLE WITH: DT8100



15-m long wire.

Reference: 024121

Unit

WIRELESS HANDLE + RECEIVER



COMPATIBLE WITH: DT8100

The receiver can deal with 10 channels at the same time (10 wireless handles). Supplied with 2 AAA batteries

Reference: 024119

Unit

DT8000 WITH WIRELESS RECEIVER



(options not included in DT8100 pack)

WIRELESS HANDLE



COMPATIBLE WITH: DT8100

Ergonomic. Supplied with 2 AAA batteries.

Reference: 024120

Unit

SPORTBEEPER PRO

2 years warranty



New Sportifrance own brand!

SportBeeper

A benchmark in the field of coaching and physical conditioning, SportBeeper has been equipping professionals and amateurs for over 20 years. Designed in France using short supply chains, it is a tool that combines expertise with eco-responsibility.



What is it?

It is a tool designed to ensure sequential and audible control of exercises or tests. It helps manage time, pace, and training phases, freeing the coach from timekeeping and whistle blowing.

To do what?

Conduct tests, follow a pace, respect precise timings (intervals or repetitions), link sets together, and structure training sessions.

Who is it for?

Teachers, coaches, fitness practitioners, runners.



Examples of possible tests:

VAM-EVAL (Cazorla) / Shuttle run (Leger) / Cooper / Time to exhaustion at MAS / Conconi / Probst, and many others.

Possible training formats:

Cyclic / Bicyclic / Combined / Paced 3.6° Gacon / Constant pace / Progressive pace / Progressive stages / Progressive stages in blocks / Timer.

Discover More



WEIGHT	LENGTH	WIDTH	HEIGHT
430 g	24 cm	11 cm	7.3 cm

RECYCLABLE

SportBeeper is the ideal tool for ensuring sequential and audible control of exercises, freeing the coach from tedious whistle blowing so they can focus exclusively on leading the session without losing sight of athletes in action. It is an intuitive, easy-to-use tool with long battery life (approximately 20 sessions of 2 hours).

Reference: 024300

The complete kit (SportBeeper Pro + tripod + mute + cable + adaptor)

Reference: 024302

The tripod alone



Sports bags, storage and transport
 Multisports
 Tracing and ground accessories
 Coach, referee and player
 Stopwatches and digital displays
 First aid
 Fitness and combat
 Swimming
 Racket sports
 Athletics
 Balls
 School
 Nets and accessories

MULTI-FUNCTION DISPLAY

Customizable text

Visible and audible at 90m

With carrying handle

Discover more

Google Play
App Store

SCORE DISPLAY:

- Team customization on 4 characters and score up to 199.



CLOCK:

- Auto synchronisation with your phone

STOPWATCH:

- Accuracy in hours/minutes/seconds



SEGMENT TIMER:

- Schedule sequences with work time and rest time
- Possibility to program several work sequences with several stages
- Display of stages and count-down-time

COUNT:

- Set the time to 99 minutes and 59 seconds. The alarm will sound at 0.

LENGTH	HEIGHT	WEIGHT
55 cm	26 cm	2 kg

With these large LED figures of 31.8 cm in height and its adjustable sound power, it is visible and audible at 90 m. It can be programmed and controlled by the supplied remote control or a smartphone via the «SEGMENT TIMER» application, which can be downloaded on iOS or Android. Control range: 20 m (remote and smartphone by Bluetooth). Autonomy of 7h (rechargeable thanks to its charger provided). Equipped with 2 removable feet, it can be placed on a table or suspended thanks to its hooks and its 2 chains of 55 cm included.

Reference: 024216

Unit

• ELECTRONIC SCOREBOARD DISPLAY / PLAYER SUBSTITUTION

RECYCLED RECYCLABLE

LENGTH	HEIGHT	WEIGHT
55 cm	26 cm	2 kg

Single-sided LED player-change panel. 2 modes: either player changeover with in/outcoming numbers (from 0 to 99), or additional time from 0 to 9 min. High visibility (120 m) - Digit size= 18 x 10 cm. Can be used as a scoreboard. Lithium battery, delivered with charger. Autonomy: 5 hours.

Reference: 068001N

Unit

• FRONT/BACK LED BOARD

RECYCLED RECYCLABLE

Player change panel and additional time mode

LENGTH	HEIGHT	WEIGHT
55 cm	26 cm	2,6 kg

Front/back LED player-change panel. 2 modes: either player changeover with in/outcoming numbers (from 0 to 99), or additional time from 0 to 9 min. High visibility (120 m) - Digit size= 18 x 10 cm. Can be used as a scoreboard. Lithium battery, delivered with charger. Autonomy: 5 hours.

Reference: 068003

Unit

First aid

Cool box and first-aid bag	96
First-aid kit and bag CLUB	98
First-aid kit and bag PRO	99
Treatment kits	100
Cold or hot treatment	101
Gels and massage creams	102
Dressings, bandages and protections	104
Straps	105
Accessories and stretcher	106
Disinfection and measuring devices	107
Stretcher and treatment tables	108

TO DISCOVER



P.101



P.99

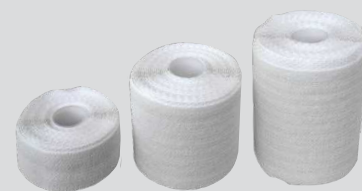

P.105



COOL BOX AND FIRST-AID BAG

• ICE BOX

Prestoglas



VOLUME	LENGTH	WIDTH	HEIGHT
55 L	49 cm	44 cm	52 cm

RECYCLABLE

Its telescopic handle and large wheels will make it easier to transport and keep your drinks or cryotherapy devices cool on any pitch. The lid has 4 cup slots and a drain plug at the back of the cooler, letting you empty out the melted ice. Color: Blue.

Reference: 066006

Unit

COOL BOX 10 L

Prestoglas



VOLUME	LENGTH	WIDTH	HEIGHT
10 L	33 cm	22 cm	31 cm

RECYCLABLE

Rigid cool box allowing to keep the cold packs or ice bags cold.

Reference: 066001

Unit

FIRST-AID BAG

SPORTI



Plasticised and zipped compartments to keep your products clean

LENGTH	WIDTH	HEIGHT
17 cm	6 cm	22 cm

100% polyester first-aid bag 600 deniers composed of 2 compartments and a flap. One of the compartments is plasticised and zipped to keep your products sheltered from possible dirt and the other is equipped with a net to faster access to the products. The flap has small pockets in order to store scissors, splinter tweezers and other material not bulky.

Reference: 078071

Unit

FIRST-AID JUNIOR BAG

Prestoglas

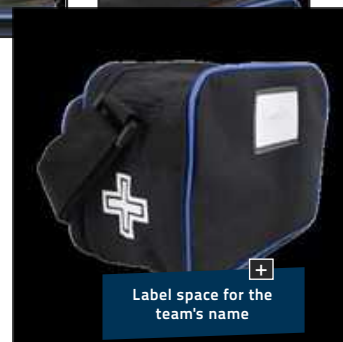

Label space for the team's name

LENGTH	WIDTH	HEIGHT
24 cm	15 cm	18 cm

100% polyester first-aid bag junior 600 deniers easy to transport thanks to its strap.

It is composed of 2 compartments: one main compartment easily accessible thanks to his double zip and an outside pocket.

Reference: 078104

Unit

FIRST AID KITS

FULL FIRST-AID KIT



1 pair of protective gloves

Kit composed of 1 set of 10 sterile compresses, 1 cold spray 150 ml, 1 roll of adhesive plaster, 1 dressing strip to cut, 1 pair of scissors, 1 stretch bandage, 1 crepe strip, 1 pair of protective gloves and 1 set of 10 70° alcohol wipes.

Reference: 066152 Unit

FULL FIRST-AID CLUB KIT



1 pair of protective gloves

Kit composed of 1 set of 10 sterile compresses, 1 cold spray 400 ml, 1 roll of adhesive plaster, 1 dressing strip to cut, 1 pair of scissors, 1 stretch bandage, 1 crepe strip, 1 pair of protective gloves and 1 set of 10 70° alcohol wipes.

Reference: 066153 Unit

FULL FIRST-AID KIT



1 pair of protective gloves

First-aid kit filled of a kit reference 066152.

Reference: 066154 Unit

FULL FIRST-AID CLUB KIT



1 pair of protective gloves

First-aid kit filled of a kit club reference 066153.

Reference: 066155 Unit

FULL FIRST-AID JUNIOR HEALER BAG



1 pair of protective gloves

First-aid bag junior 24 cm filled of a first-aid kit reference 066152.

Reference: 066183 Unit

FULL FIRST-AID CLUB JUNIOR HEALER BAG



1 pair of protective gloves

First-aid bag junior 24 cm filled of a first-aid kit club reference 066153.

Reference: 066184 Unit

Sports bags, storage and transport

Multisports

Tracing and ground accessories

Coach, referee and player

First aid

Fitness, bodybuilding and gym

Swimming

Combat sports

Racket sports

Athletics

Balls

School

Nets and accessories

FIRST-AID CLUB HEALER BAG

Prestoglas®



+ Isothermal compartment



+ Label space for the team's name



LENGTH	WIDTH	HEIGHT
38 cm	24 cm	24 cm

100% polyester first-aid bag CLUB 600 deniers. Easy to transport thanks of its strap and very easy use for all your senior teams. It is composed of 3 compartments:
 -one main compartment with removable separations and an easy access to the products facilitate by a large double zip.
 -an isothermal compartment allowing to store Cryo products like cold packs.
 -a large zipped pocket with several compartments.

Reference: 078105

Unit

FIRST-AID CLUB HEALER KIT



Kit composed of 1 cold spray 400 ml, 2 cold packs at single use, 1 dressing strip to cut, 1 box of 20 dressings, 3 packets of 3 stitches, 1 set of 10 sterile compresses, 1 roll of adhesive plaster, 1 pair of scissors, 1 splinter tweezers, 1 stretch bandage, 1 crepe strip, 1 pair of protective gloves, 1 survival blanket, 1 set of 10 70° alcohol wipes, 1 elastic adhesive strip of 6 cm, 1 elastic adhesive strip (blue) 7.5 cm x 4.5 m and 1 flask of 100 ml of 70° alcohol.

Reference: 066156

Unit

FULL FIRST-AID CLUB HEALER BAG



First-aid bag club filled of a first-aid kit club reference 066156.

Reference: 066157

Unit

FIRST-AID CLUB PRO HEALER BAG

Prestoglas®



Large opening in u-shape +



Several storage compartments +



Easy to transport thanks to its strap +



Isothermal compartment +



Label space for the team's name +

LENGTH	WIDTH	HEIGHT
47 cm	23 cm	28 cm

This bag has the same kit than the CLUB bag, but it is larger therefore this PRO bag will allow you to offer your team a large product range to increase the comfort of your players.

Reference: 078106

Unit

FIRST-AID CLUB PRO HEALER KIT



2 pairs of protective gloves

This kit is composed of 2 cold sprays 400 ml, 2 cold packs at single use, 1 dressing strip to cut, 1 box of 20 dressings, 5 steri strip packets of 3 stitches, 1 set of 10 sterile compresses, 1 roll of adhesive plaster, 1 pair of scissors, 1 splinter tweezers, 2 stretch bandages, 2 crepe strips, 2 pair of protective gloves, 1 survival blanket, 1 set of 10 70° alcohol wipes, 1 set of 10 Chlorhexidine wipes, 1 elastic adhesive strip 3 cm, 2 elastic adhesive strips 6cm, 1 elastic adhesive strip 8 cm, 1 (blue) elastic cohesive strip 7.5 cm x 4.5 m, 1 flask of 100 ml of 70° alcohol, 1 camphor oil of 250 ml, 1 heating gel of 150 ml, 1 arnica gel 250 ml, 1 oriental balm of 100 ml.

Reference: 066181

Unit

FULL FIRST-AID CLUB PRO HEALER BAG



2 pairs of protective gloves

First-aid bag PRO filled of a first-aid kit PRO reference 066181.

Reference: 066182

Unit

Sports bags, storage and transport
 Multisports
 Tracing and ground accessories
 Coach, referee and player
 First aid
 Fitness, bodybuilding and gym
 Swimming
 Combat sports
 Racket sports
 Athletics
 Balls
 School
 Nets and accessories

TREATMENT KITS

TREATMENT KIT N°1



Composed of 6 cold sprays 400 ml, 10 cold packs at single use, 3 sets of 10 sterile compresses (so 30 compresses), 6 rolls of adhesive plaster, 6 dressing strips to cut 6 cm x 50 cm, 6 flasks of 100 ml of 70° alcohol and 6 crepe strips.

Reference: 066158

Unit

TREATMENT KIT N°2



Treatment kit promo 1 + 6 elastic adhesive strips 6 cm + 6 blue elastic adhesive strip 7.5 cm x 4.5 m.

Reference: 066159

Unit

KIT STOCK CLUB

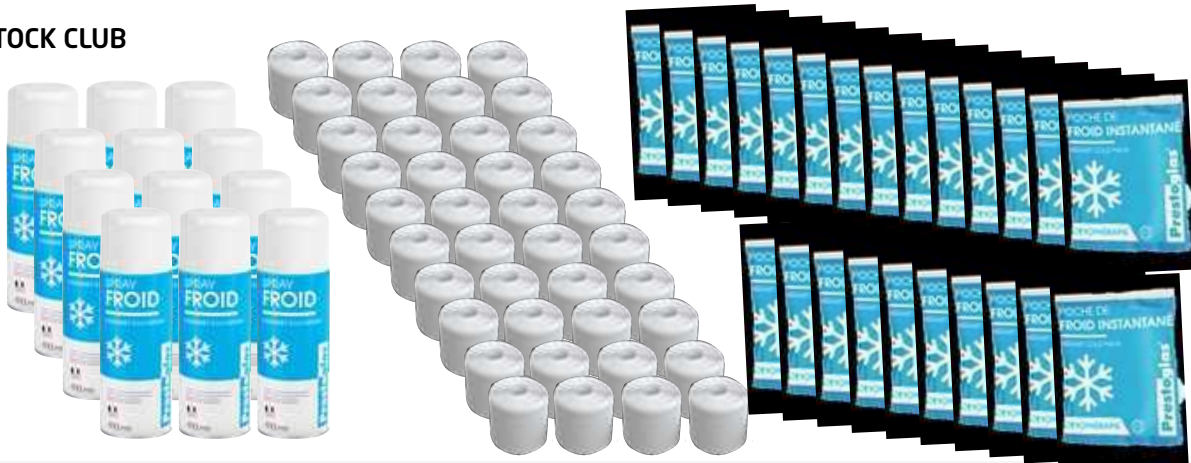

Composed of 12 cold sprays + 40 elastic adhesive strips 6 cm + 24 instant cold packs.

Reference: 066129

Unit

ICE BAG



LENGTH
28 cm

Hermetic closure. It eases pains linked to shock.

Reference: 066012

Unit

COOL BOX 10 L

Prestoglas



RECYCLABLE
VOLUME
10 L
LENGTH
33 cm
WIDTH
22 cm
HEIGHT
31 cm

Rigid cool box allowing to keep the cold packs or ice bags cold.

Reference: 066001

Unit

**COLD SPRAY
150 ML**



Prestoglas



Packaging:
box of 12

VOLUME
150 ml

Immediate action. Classic spray with the Prestoglas quality. Conceived to ease the post-traumatic pain by the cold. It reduces the sensation of pain.

Reference: 066167 Unit

**COLD SPRAY
400 ML**



Prestoglas



Packaging:
box of 12

VOLUME
400 ml

Immediate action. Classic spray with the Prestoglas quality. Conceived to ease the post-traumatic pain by the cold. It reduces the sensation of pain.

Reference: 066110 Unit

**COLD SPRAY WITH
ARNICA 400 ML**



Prestoglas



Packaging:
box of 12

VOLUME
400 ml

Immediate action.
Cold spray with arnica to improve efficiency.

Reference: 066168 Unit

REUSABLE CUSHION HOT/COLD WITH STRAP



LENGTH
26 cm

WIDTH
10 cm

Thanks to its elastic, extensible and robust band, this compress can be applied on different body parts, directly on skin. The new gel formula (can't solidified it) guarantees a perfect adaptability as soon as the freezer way out.

Reference: 066190 Unit

INSTANT COLD PACK

Prestoglas



Packaging:
box of 12

LENGTH
18 cm

WIDTH
15 cm

Instant cold by pressure essential in all sports club to treat the knocks or muscular incidents.

Reference: 066008 Unit

SET OF 6 HEAT PATCHES



Set of 6 heating patches at essential oils of dimensions 16 cm x 11 cm at single use, in flesh-coloured elastic adhesive fabric, at oleocapsicum oil (1%). Individual vacuum pack. Set of 6.

Reference: 066172 Set

**REUSABLE HOT/COLD COMPRESS
10 X 10 CM**



Reference: 066166 Unit

Reference: 066143L Box of 6

Soft fabric and comfortable and gel small cushion which hugs body part's figure to treat. Set of 6 compresses of dimensions 10 x 10 cm.

**REUSABLE HOT/COLD COMPRESS
10 X 26 CM**



Reference: 066165 Unit

Reference: 066142L Box of 6

Reusable gel small cushion. Delivered with an anti-irritation and non-woven cover to increase comfort. Box of 6 compresses of dimensions 10 x 26 cm.



Sports bags, storage and transport
Multisports
Tracing and ground accessories
Coach, referee and player
First aid
Fitness, bodybuilding and gym
Swimming
Combat sports
Racket sports
Athletics
Balls
School
Nets and accessories

MASSAGE OIL WITH ARNICA

Prestoglas



+ 100% natural

Vegetable massage oil in which Arnica macerated during 4 weeks (therefore it has a maximum concentration in Arnica), is perfect for preparation and muscular recovery.

Reference: 066178A 100 ml
Reference: 066178B 250 ml

CAMPHORATED MASSAGE OIL

Prestoglas



Advantage: content in superior camphor at standard +

Its enjoyable texture and its camphoric smell, will be useful during massages as part of physical preparation. It allows to obtain quickly a warm feeling.

Reference: 066161A 250 ml
Reference: 066161B 500 ml

ORIENTAL BALM 100 ML

Prestoglas



VOLUME 100 ml

Coming from the balm Thai, its content in essential oils is less concentrated but has the same components. It allows you to massage more widely. As effective to prepare muscles to effort as to ease them. You need to have this product in your first-aid bag.

Reference: 066164 Unit

CATAPLASM WITH CLAY 500 ML

Prestoglas



VOLUME 500 ml

Cataplasme made from Kaolin of mentholated high quality. To use alone or with a plastic film. Perfect for an active recovery after the effort and to prevent aches.

Reference: 066179 Unit

VASELINE 500 ML

Prestoglas



VOLUME 500 ml

To avoid the effects of the warm-up and the rubbings on the sensitive areas.

Reference: 066171 Unit

STRETCH FILM REEL

Prestoglas



Film size
w. 12.5 cm
L. 200 m

Transparent stretch film 17 micrometres. To wrap the cataplasme or the application gel.

Reference: 066180 Unit

Sports bags, storage and transport
Multisports
Tracing and ground accessories
Coach, referee and player
First aid
Fitness, bodybuilding and gym
Swimming
Combat sports
Racket sports
Athletics
Balls
School
Nets and accessories

GELS AND MASSAGE CREAMS



WARM-UP GEL
Prestoglas



ARNICA CRYO GEL
Prestoglas



ANTI-FRICTION CREAM
Prestoglas



ARNICA CREAM
Prestoglas



VOLUME
150 ml

It allows to get quickly a durable warm feeling during physical preparation.

Reference: 066127

VOLUME
150 ml

Ideal for sports recovery. This gel relieves and soothes muscles after effort. Intense cold sensation.

Reference: 066128

VOLUME
150 ml

Anti-friction cream will allow you to protect your skin against irritations and to avoid having red patches and blisters.

Reference: 066126

VOLUME
150 ml

Ideal for sports recovery. This gel relieves and soothes muscles after effort.

Reference: 066100

• DISPLAY FOR CREAMS
Prestoglas



Separate display for massage gels and creams.

Reference: 066099

Separate display

SET OF 20 SPORT GELS AND CREAMS

Pre



display and

Set of 20 Prestoglas gels and creams: 5 Arnica cryo gels 066128, 5 anti-friction creams 066126 et 5 Arnica creams 066100 + **FREE display stand.**

Reference: 066098

The complete kit



Sports bags, storage and transport

Multisports

Tracing and ground accessories

Coach, referee and player

First aid

Fitness, bodybuilding and gym

Swimming

Combat sports

Racket sports

Athletics

Balls

School

Nets and accessories

VELPEAU STRAPP BANDAGE



Packaging: box of 18

LENGTH 2.5 m

Elastic adhesive bandage. Very strong holding on the skin and high skin tolerance. Bandage WITHOUT LATEX.

Reference: 066120	3 cm x 2.5 m
Reference: 066121	6 cm x 2.5 m
Reference: 066122	8 cm x 2.5 m

ELASTIC ADHESIVE BANDAGE



One of the best value for money of the market +

Packaging: 3 cm: box of 80
6 cm: box of 40
8 cm: box of 80

LENGTH 2.5 m

Elastic bandage of white colour. For flexible immobilisations, 100 % cotton, resistant and hypoallergenic. It is very adhesive and extensible of about 50%.

Reference: 066107	3 cm x 2.5 m
Reference: 066108	6 cm x 2.5 m
Reference: 066109	8 cm x 2.5 m

SPORT TAPE



LENGTH 5 m **WIDTH** 5 cm

Elastic adhesive bandage, used to preventing injuries, offer a mechanical support to muscles, align the body and reduce inflammations. Waterproof and breathing. Available in colours: black, blue, pink and beige.

Reference: 066138 5 cm x 5 m

ELASTIC COHESIVE BANDAGE



LENGTH 4.5 m **WIDTH** 7.5 cm

Elastic cohesive bandage 80 % polyester and 20 % elastane. It sticks on itself and not directly on the skin. For flexible immobilisations or compressions. It can also be used to hold the cold packs. Colour: blue.

Reference: 066005 Unit

NON-ELASTIC ADHESIVE BANDAGE



Packaging: 2.5 cm: box of 36
4 cm: box of 24

LENGTH 10 m

Used for the conception of the rigid joint immobilisations. Important stickiness extended. Divisible by hand. 10 m length. Available in 2 widths (2.5 cm and 4 cm).

Reference: 066003A	2.5 cm x 10 m
Reference: 066003B	4 cm x 10 m

PROTECTIVE FOAM



LENGTH 27 m **WIDTH** 7 cm

Elastic sub-bandage, protective foam of the skin and hair system. Auto-adhesive. Divisible by hand. Colour: beige.

Reference: 066140 Unit

Sports bags, storage and transport

Multisports

Tracing and ground accessories

Coach, referee and player

First aid

Fitness, bodybuilding and gym

Swimming

Combat sports

Racket sports

Athletics

Balls

School

Nets and accessories

CREPE BANDAGE



LENGTH 4 m
WIDTH 7 cm

Reference: 066119

Unit

ELASTIC BANDAGE



LENGTH 3 m
WIDTH 7 cm

Reference: 066117

Unit

ABSORBENT COTTON



Packet of 100 gr of absorbent cotton.

Reference: 066148

Unit

NASAL PLUGS



Packet of 40 cotton nasal plugs to stop nose bleeds.

Reference: 066147

Packet

SPLINTER TWEEZERS



Splinter tweezers with pointed tips of 11 cm. Sold by the unit.

Reference: 066032

PAIR OF SCISSORS



Reference: 066123

SURVIVAL BLANKET



LENGTH 210 cm
WIDTH 160 cm

Survival blanket (gold/silver).

Reference: 066029

VINYL GLOVES



Vinyl gloves. Sold per pair.

Reference: 066124

SET OF 10
70° ALCOHOL WIPES



SET OF 10
CHLORHEXIDINE WIPES



SET OF 10
CALENDULA WIPES



ARNICA PACK SET OF
3X3 PODS OF 0.8 ML



RECYCLABLE

Set of 10 70° alcohol wipes, cleaner and disinfectant.
Reference: 066073

RECYCLABLE

Set of 10 Chlorhexidine wipes, cleaner and disinfectant without alcohol.
Reference: 066074

RECYCLABLE

Set of 10 Calendula wipes, soothing solution for knocks.
Reference: 066075

Texture developed to penetrate without let an oily skin.
Reference: 066151

70° ALCOHOL 100 ML



VOLUME
100 ml

It allows to clean and disinfect the area to treat.
Spray.
Reference: 066149 Unit

100 ML CHLORHEXIDINE



VOLUME
100 ml

It allows to clean and disinfect the area to treat.
Without alcohol. Spray.
Reference: 066150 Unit

• 100 ML
HYDROALCOHOLIC GEL



VOLUME
100 ml

For the disinfection of hands by friction, without water.
Reference: 066195 Unit

INFRA-RED THERMOMETER
CONTACTLESS



RECYCLABLE

Contactless infra-red thermometer, takes the temperature quickly (1 second) and precisely. Digital display. Measurement distance: 1-5 cm.
Reference: 066212 Unit

• OXIMETER



Reference: 066185 Unit

The digital oximeter allows you to regularly and simply check your blood oxygen level (SpO2), your pulse and the shape of your plethysmographic wave: Thanks to the LCD screen and to the large numbers, it gives an instantaneous and easy to read picture of your condition.

Sports bags, storage and transport
Multisports
Tracing and ground accessories
Coach, referee and player
First aid
Fitness, bodybuilding and gym
Swimming
Combat sports
Racket sports
Athletics
Balls
School
Nets and accessories

HEALER ARMBAND



WIDTH 9 cm
LENGTH 35 cm

With elastic and large hook and loop fastener to increase comfort.

Reference: 063262

Unit

MEDICAL STAFF ARMBAND



WIDTH 9 cm
LENGTH 35 cm

With elastic and large hook and loop fastener to increase comfort.

Reference: 063263

Unit

• STRETCHER



FOLDED

POIDS 5.2 kg
LENGTH 205.5 cm
WIDTH 53 cm
HEIGHT 13 cm

Folding stretcher double folded across the width. Feet, retractors and aluminium handles. Nylon coating covering with PVC. Fire and water resistance. Washable.

Reference: 066186

Unit

INFIRMARY FURNITURE

FOLDING AND FIXED TABLE



Reference: 066189 - 45 kg



Reference: 066188 - 14.2 kg

Sports bags, storage and transport
Multisports
Tracing and ground accessories
Coach, referee and player
First aid
Fitness, bodybuilding and gym
Swimming
Combat sports
Racket sports
Athletics
Balls
School
Nets and accessories

Fitness and combat

Mats and mat holder	110
Yoga	112
Gymball, fitness roll, balls and special balls	113
Balance, proprioception and trampoline	114
Steppers	115
Muscle strengthening	116
Skipping ropes	122
Hemp ropes	123
Boxing	124
Judo and Karate	125
Rhythmic gymnastics	126

Sports bags, storage and transport

Multisports

Tracing and ground accessories

Coach, referee and player

First aid

Fitness, bodybuilding and gym

Swimming

Combat sports

Racket sports

Athletics

Balls

School

Nets and accessories

TO DISCOVER



P.111



P.117

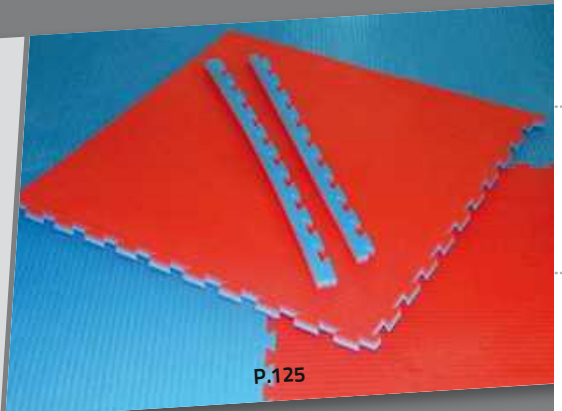

P.125



MATS AND MAT HOLDER

FOAM GYM MAT

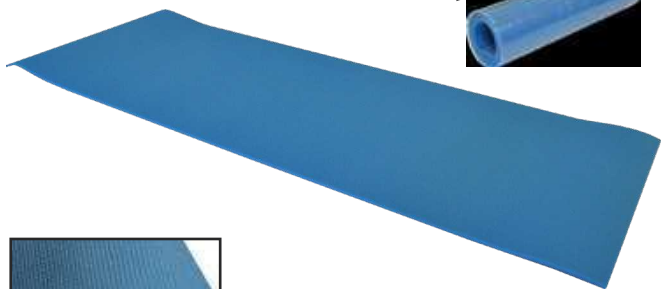

LENGTH	WIDTH	THICKNESS
140 cm	50 cm	7 mm

Turquoise colour. Non-slip coating on 1 face.

Reference: 043018 Unit

FOLDING GYM MAT

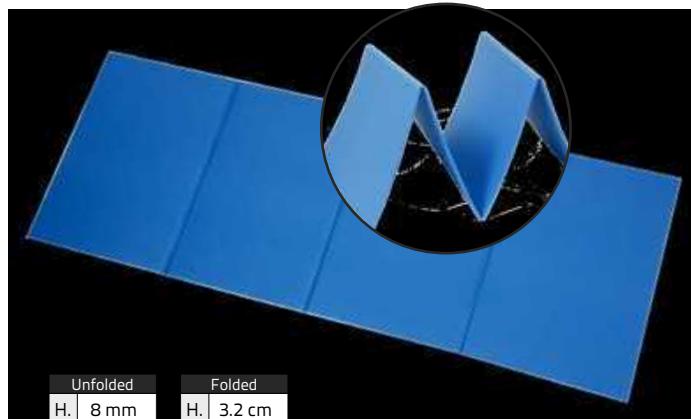

	Unfolded	Folded
H.	8 mm	3.2 cm
w.	50 cm	50 cm
L.	140 cm	35 cm

Folding gym mat in waterproof polyethylene foam, anti-fungal infection biological coating. Blue colour.

Reference: 043015 Unit



ELASTIC TO TRANSPORT THE MAT



Makes the transport of your mats easier.

Reference: 043014 Unit

MAT BAG



Can contain up to 16 mats (ref: 043015) +

LENGTH	WIDTH	HEIGHT
80 cm	48 cm	33 cm

Nylon canvas bag reinforced 600 deniers. It is composed of a large main compartment with an opening in U to easily store until 16 folding mats (ref: 043015). Side pocket with opening in U. Transport handles and adjustable and reinforced shoulder strap. Colour: black. Delivered without mat.

Reference: 011084 Unit

MOBILE MATS HOLDER



+ Adjustable space

+ Handle to move it



CAPACITY	WEIGHT	HEIGHT
≈ 40 mats	10 kg	2.09 m

Mounted on 4 swivel castors, this support can contain about 40 mats (according to their thickness). The width of the mat holder is adjustable to adapt it to the space between the eyelets (adjustment without tool). Supplied with a handle to move it. Floor space 69 x 51 cm.

Reference: 043000 Unit

WALL-MOUNTED MATS HOLDER



Ø8 mm

Wall mat holder, adjustable according to the space between the eyelets. Can contain up to 20 mats.

Reference: 043002 Unit



140 CM MAT



Delivered rolled with an elastic carrier +

LENGTH	WIDTH	THICKNESS
140 cm	60 cm	10 mm

With eyelets. Delivered rolled with a carriage elastic. High-quality foam mat.

Reference: 043017	140 x 60 x 1 cm - Grey
Reference: 043017B	140 x 60 x 1 cm - Blue

183 CM MAT



Delivered rolled with an elastic carrier +



LENGTH	WIDTH	THICKNESS
183 cm	61 cm	10 mm

With eyelets. Delivered rolled with a carriage elastic. Foam mat of high quality.

Reference: 043013	183 x 60 x 1 cm - Black
-------------------	-------------------------

EXTRA FOAM GYM MAT



LENGTH	WIDTH	THICKNESS
180 cm	60 cm	8 mm

Extra foam gym mat, blue colour. With eyelets.

Reference: 043011	Unit
-------------------	------

140 CM AND 180 CM COMFORT GYM MAT



Comfort gym mat, non-slip foam, woven coating.

Reference: 043016A	140 x 60 x 0.8 cm	Unit
Reference: 043016B	180 x 60 x 0.8 cm	Unit

Sports bags, storage and transport

Multisports

Tracing and ground accessories

Coach, referee and player

First aid

Fitness, bodybuilding and gym

Swimming

Combat sports

Racket sports

Athletics

Balls

School

Nets and accessories

YOGA

• CORK YOGA MAT

SPORTi



LENGTH	WIDTH	THICKNESS
183 cm	61 cm	5 mm

Perfect for yoga or Pilate practice. Mat with a foam side and a cork side. It also has an alignment mark to help you for your postures. Cork allows to have a more resistant mat, non-skid and antibacterial. Advantage: double-sided.

Reference: 044127 Unit

INDIVIDUAL MAT BAG

SPORTi



DIAMETER	LENGTH
23 cm	70 cm

Perfect to transport your mats. With a shoulder strap.

Reference: 044128 Unit

YOGA BALANCE BLOCK

SPORTi



WEIGHT	LENGTH	WIDTH	HEIGHT
200 g	22.5 cm	15 cm	7.5 cm

Blue EVA foam block. Very useful to maintain your yoga alignment and posture.

Reference: 044118 Unit

YOGA WHEEL

SPORTi

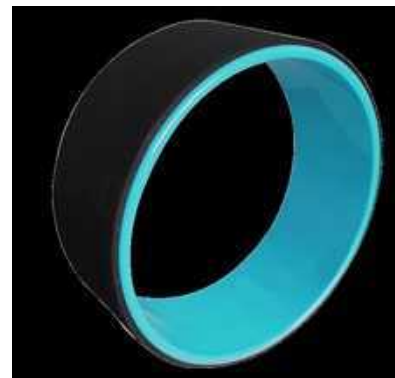

DIAMETER	WIDTH
33 cm	13 cm

Ideal to safely stretch, strengthen, and tone your body. Non-skid foam coating for greater comfort and safety.

Reference: 044115 Unit

BELT

SPORTi



LENGTH	WIDTH
182 cm	3.8 cm

Ideal to perform difficult exercises during your yoga sessions. Black polyester and cotton belt.

Reference: 044116 Unit

90CM FOAM ROLLER

SPORTi

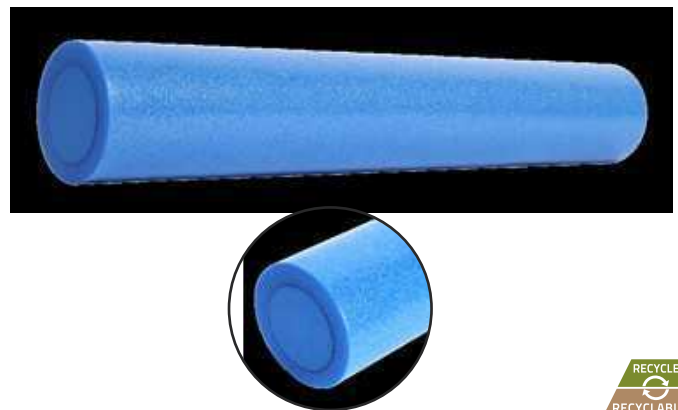

DIAMETER	LENGTH
15 cm	90 cm

Ideal for strengthening muscles, balance work and flexibility. In solid foam.

Reference: 044117 Unit

GYMBALL SUPPORT

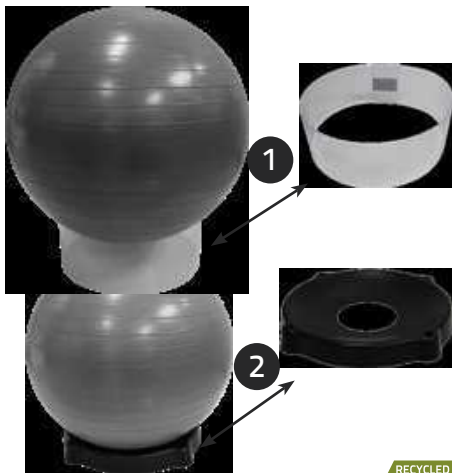

- Reference: 044097 1. Transparent intermediate support
- Reference: 044096 2. Black Gymball support



GYMBALL



Practical advice:
The good size of the ball is equal to the distance from the ground to your knees.



Ideal for core strength and stability programs that target toning, stretching, back care, balance and rehabilitation. Durable, anti-burst construction (even in contact with a sharp object) - easy to use and easy to clean. Up to 300 kg. Supplied with 2 air stoppers and 1 remover. Individual packing. Diameter +/- 10%.

Reference: 044130	Ø: 55 cm.	900 gr	Light grey
Reference: 044131	Ø: 65 cm.	1100 gr	Turquoise
Reference: 044132	Ø: 75 cm.	1300 gr	Dark grey
Reference: 044114	1. Plug remover		

FITNESS ROLL



DIAMETER	WEIGHT	LENGTH
14 cm	630 g	33 cm

Massage roll in PE foam. Flexible relief structure allowing an optimal massage. Perfect to treat muscular aches and to improve blood circulation.

Reference: 044088 Unit

PILATE RING



Lightweight, flexible ring that provides resistance for your muscles. With two padded handles on either side.

Reference: 044086 Unit

"ELEPHANT SKIN" BALLS



Puncture-proof+



In polyurethane retractable foam, they are covered with an elastomere skin. This "puncture-proof" ball becomes distorted and reformed in a few seconds for multiple uses. Very flexible, resistant and washable.

Reference: 099337	7 cm Ø	Green / Blue
Reference: 099338	16 cm Ø	Yellow / Red
Reference: 099339	18 cm Ø	Green / Red
Reference: 099340	21 cm Ø	Blue / Yellow

HEDGEHOG MASSAGE BALL



Soft pimple balls are designed for soft massages and stimulation of the reflex zones. They boost blood circulation.

Reference: 099341	6 cm Ø	40 g
Reference: 099342	7 cm Ø	50 g
Reference: 099343	8 cm Ø	70 g
Reference: 099344	9 cm Ø	90 g
Reference: 099379	10 cm Ø	150 g

ULTRA-LIGHT STRAW BALLS

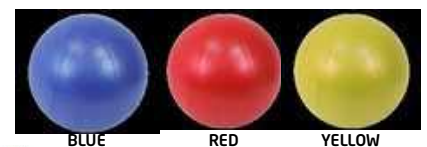

DIAMETER	WEIGHT
25 cm	180 g

Flexible and very light PVC ball, without phthalate, inflatable with the mouth with a straw. Available in 3 colours: Blue / Yellow / Red.

Reference: 099157 Unit

Sports bags, storage and transport
Multisports
Tracing and ground accessories
Coach, referee and player
First aid
Fitness, bodybuilding and gym
Swimming
Combat sports
Racket sports
Athletics
Balls
School
Nets and accessories

BALANCE BALL TRAINER



Removable elastic +



Delivered with a pump +



CAUTIONS:
To avoid that the dome comes off the base, make sure:
- Not to overinflate the dome beyond a 22 cm height
- Keep away from direct heat/sun.

DIAMETER	WEIGHT	HEIGHT
63 cm	6 kg	22 cm

Material allowing the work of balance, abdominals, gluteus and back muscles strengthening. It also allows to work your proprioception. Removable elastics included. Maximum weight: 150 kg.

Reference: 044078 Unit

PILATES AIR CUSHION



Non-skid underside +

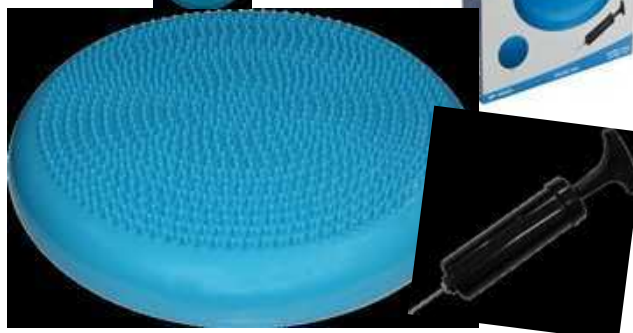

Delivered with a pump +

DIAMETER	HEIGHT
33 cm	7 cm

Ideal for improving balance and posture, proprioception and stimulation of foot soles. Maximum weight: 100 kg.

Reference: 044073 Unit

BALANCE PLATFORM



DIAMETER	HEIGHT
39.5 cm	8 cm

Perfect to develop the static balance. Wooden board with non-skid surface. Half sphere for the first feeling balance. Max weight: 110 kg.

Reference: 082027 Unit

ROUND BALANCE BOARD



DIAMETER	HEIGHT
40 cm	8 cm

Essential accessory for rehabilitation. The search of a balance allows an effective work of deep muscles by reinforcing the abdominals. Its non-skid pan allows a safety training. Maximum weight: 150 kg.

Reference: 044071 Unit

TRAMPOLINE 1 M



HEIGHT	DIAMETER
22.5 cm	1 m

Black trampoline for muscular strengthening and coordination. 6 metal legs equipped with non-skid pads. Jump surface: 77 cm. Max weight: 100 kg.

Reference: 031212 Unit

COVER FOR MINI TRAMPOLINE 1 M



Replacement cover for 1 m trampoline – Ref. 031212

Reference: 031212H Unit

BALANCE PAD



LENGTH	WIDTH	HEIGHT
48 cm	39 cm	6 cm

Perfect tool for muscle strengthening and improving balance. Use it to improve your coordination stability and proprioception. Very comfortable foam balance pad.

Reference: 044098 Unit

STEPPER 68 X 28 CM - 2 HEIGHTS

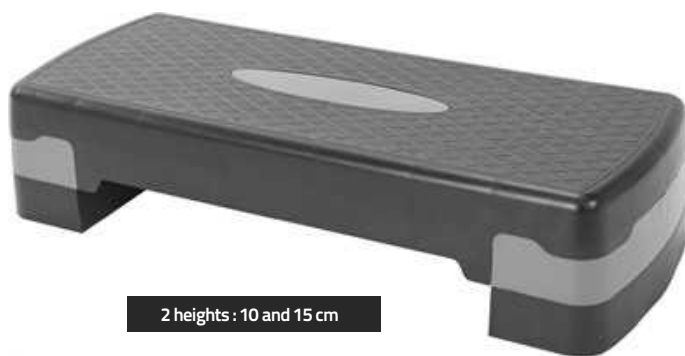

2 heights : 10 and 15 cm

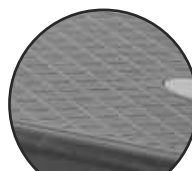

Non-slip stepper surface



Delivered with a pair of 5 cm adjustable blocks

LENGTH	WIDTH	HEIGHT
68 cm	28 cm	15 cm

Non-slip stepper surface for a safer work. 2 additional riser blocks to change height from 10 to 15 cm. Both riser blocks can be stored under the stepper. Max weight: 120 kg.

Reference: 044101 Stepper + adjustable risers

STEP 78 X 29 CM - 3 HEIGHTS



1

3 heights : 10, 15 and 20 cm



2



3

Panel	
w.	29 cm
L.	78 cm



Its non-slip surface allows for safe work. Being able to adjust the height of the step (10 cm, 15 cm and 20 cm) allows you to adjust the level according to your abilities and objectives. Possibility of storing the extensions under the step. Max weight: 120 kg.

- Reference: 044008 1 Stepper + set of 2 risers
- Reference: 044084 2 Single stepper
- Reference: 044085 3 Set of 2.5 cm risers (4 pieces)

• AQUASTEPPER



WEIGHT	LENGTH	WIDTH	HEIGHT
4,5 kg	67 cm	35 cm	19 cm

Polypropylene stepper designed for aqua fitness. Equipped with 8 silicone suckers to stick perfectly to all kinds of swimmingpool linings. Possibility to weight the stepper if the suckers are not strong enough (on mosaic tiles for example).

Reference: 044100 Unit

Sports bags, storage and transport
 Multisports
 Training and ground accessories
 Coach, referee and player
 First aid
 Fitness, bodybuilding and gym
 Swimming
 Combat sports
 Racket sports
 Athletics
 Balls
 School
 Nets and accessories

MUSCLE STRENGTHENING



STRENGTH TRAINING BAR + 2 STOP DISCS

Strength training bar of 1.40 m length and 28 mm diameter, supplied with 2 stop-discs.

Reference: 062778 6.96 kg.



BARBELLS + 2 STOP DISCS

Barbells of 38 cm length and 28 mm diameter, supplied with 2 stop-discs.

Reference: 062779 2.04 kg.



STOP DISCS

It allows to block the weights on the strength training bars of 28 mm diameter in order to avoid any risk of injury.

Reference: 062725 Pair

• CAST-IRON WEIGHT DISC



• COLOUR WEIGHT DISC

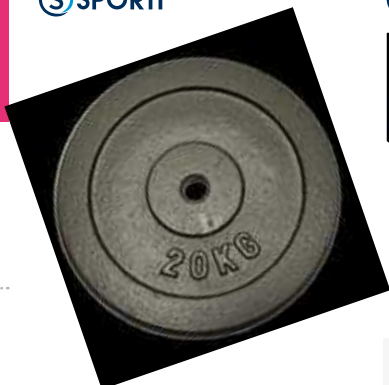

Cast-iron weight disc covered with rubber, adapted to strength training bars of 28 mm diameter.

Cast-iron weight disc adapted to strength training bars of 28 mm diameter.

Ref: 062758 5 kg.
Ref: 062759 10 kg.
Ref: 062760 20 kg.

Ref: 062729 0.5 kg - Blue
Ref: 062730 1 kg - Grey
Ref: 062731 2 kg - Red
Ref: 062732 5 kg - Green
Ref: 062733 10 kg - Yellow
Ref: 062734 15 kg - Black

WEIGHTED BARS



DIAMETER 28 mm

It has a length adapted to all morphologies and one diameter easy to hold for everybody (28 mm), this steel tube covered with polyethylene to increase comfort, does not fold up. Ends covered with a large rubber stopper (does not ruin the floor).

Reference: 044079A	1 kg.	Orange
Reference: 044079B	1.5 kg.	Grey
Reference: 044079C	2 kg.	Blue
Reference: 044079D	3 kg.	Red
Reference: 044079E	4 kg.	Green
Reference: 044079F	5 kg.	Black

ABDOMINAL WHEEL / AB WHEEL



PUSH-UP HANDLES



HAND GRIP



RECYCLABLE

Ideal for the strengthening of abdominal muscles, arms and shoulders. Double wheels for greater stability. Foam handles coating for greater comfort and security.

Reference: 044009 Unit

RECYCLABLE

Set of 2 handles to do push-ups with stability. Foam coating for greater comfort. Sold per pair.

Reference: 044109 Pair

RECYCLED
RECYCLABLE

To develop the muscles of the hand and forearm. Spring of excellent quality and very good catch in hand due to the comfort provided by its foam ergonomic handles. Sold by pair. Colour: Black/Blue.

Reference: 044062 Pair

PAIR OF CEMENT DUMBBELLS



+ Available in kit with support

Cement dumbbells coated with vinyl of different colours for a better spotting. Resistant and easy to handle.

Reference: 044010	2 x 0.5 kg	Light blue
Reference: 044012	2 x 1 kg	Green
Reference: 044013	2 x 1.5 kg	Purple
Reference: 044014	2 x 2 kg	Grey
Reference: 044015	2 x 3 kg	Red
Reference: 044016	2 x 4 kg	Black
Reference: 044022	2 x 5 kg	Blue
Reference: 044090	Support for dumbbells	
Reference: 044091	Kit 2 x 1 kg. + 2 x 2 kg. + 2 x 3 kg. + support	

NEOPRENE WEIGHTED WRISTBANDS



2 X 1 KG



2 X 1.5 KG



2 X 2 KG

+ Neoprene coating

Neoprene coating for greater comfort and wear resistance. Easily adjustable at ankles and wrists thanks to its large hook and loop fastener strip for a better hold. Sold per pair.

Reference: 044049	2 x 0.5 kg.	Blue
Reference: 044050	2 x 1 kg.	Red
Reference: 044051	2 x 1.5 kg.	Grey
Reference: 044052	2 x 2 kg.	Black

VINYL PAIR OF DUMBBELLS



Hexagonal metal dumbbells coated with vinyl allowing a good grip. They are very resistant. One colour per weight for a better recognition. Sold per pair.

Reference: 044069	2 x 0.5 kg	Red
Reference: 044063	2 x 1 kg	Blue
Reference: 044064	2 x 1.5 kg	Green
Reference: 044065	2 x 2 kg	Pink
Reference: 044066	2 x 3 kg	Grey
Reference: 044067	2 x 4 kg	Yellow
Reference: 044068	2 x 5 kg	Black

HEXAGONAL DUMBBELL



Hexagonal PVC dumbbell with slip-resistant chrome-plated steel handle. Its hexagonal shape prevents from rolling on the floor. Sold individually.

Reference: 044136	6 kg.
Reference: 044137	8 kg.
Reference: 044138	10 kg.
Reference: 044139	12.5 kg.
Reference: 044140	15 kg.
Reference: 044142	20 kg.

MUSCLE STRENGTHENING

10 M LONG BATTLE ROPE



WEIGHT
3.75 kg

DIAMETER
2.6 cm

WEIGHT
8 kg

DIAMETER
3.8 cm



The battle rope is perfect for cardio and strength trainings of high intensity. It can be used both indoor and outdoor. Protective tape at the ends. Nylon rope. It is strongly advised to put a protective tape at the contact point with the support (posts or others) in order to reduce the abrasion.

- Reference: 044111 Rope 10 m - Ø: 2.6 cm
- Reference: 044108 Rope 10 m - Ø: 3.8 cm
- Reference: 044112 Hook for battle rope

SET OF 3 PLYOMETRICS PLATFORMS



60 CM

45 CM

30 CM



Easy storage



Ideal for plyometric and cross training allowing to increase muscles explosive power. 3 different jump heights: 30 cm, 45 cm and 60 cm. Non-skid coating on top and rubber pads under each platform for greater security. Integrated set for a useful storage.

- Reference: 044129 Set of 3

PARALLEL BARS



Tube
Ø 38 mm



HEIGHT
73 cm

Parallel bars allowing to work all muscles both in static or dynamic positions. Training intensity may vary thanks to body weight. User-friendly and multifunctional. Rigid structure with 8 nozzles for better ground adhesion and security. Sold per pair.

- Reference: 044125 Pair

• WOODEN/EVA PLYOBOX 3 IN 1



WEIGHT
27 kg

DEPTH
61 kg

WIDTH
76 cm

HEIGHT
51 cm

Plyometric platform with 3 heights (51 cm, 61 cm and 76 cm) allowing to work spring and explosivity. Its internal wooden structure provides stability and the foam covering EVA and anti-slip vinyl guarantee a safe work. Dimensions: 51 x 61 x 76 cm. Weight: 27 kg

- Reference: 044141 Unit

KETTLEBELL
SPORTI



Vinyl kettlebell.

Reference: 044119	4 kg.	Pink
Reference: 044120	8 kg.	Yellow
Reference: 044121	10 kg.	Grey
Reference: 044122	12 kg.	Blue
Reference: 044123	16 kg.	Red
Reference: 044124	20 kg.	Black

WALL BALL / WEIGHTED BODYBUILDING BALL

SPORTI

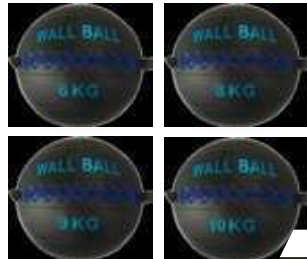

Adapted to the practice of Cross Training and Crossfit. Black vinyl coating. Identifiable weight which helps during the trainings. It absorbs shocks and does not bounce.

Reference: 044017	4 kg
Reference: 044018	6 kg
Reference: 044019	8 kg
Reference: 044020	9 kg
Reference: 044021	10 kg

TRAINING HARNESS

SPORTI

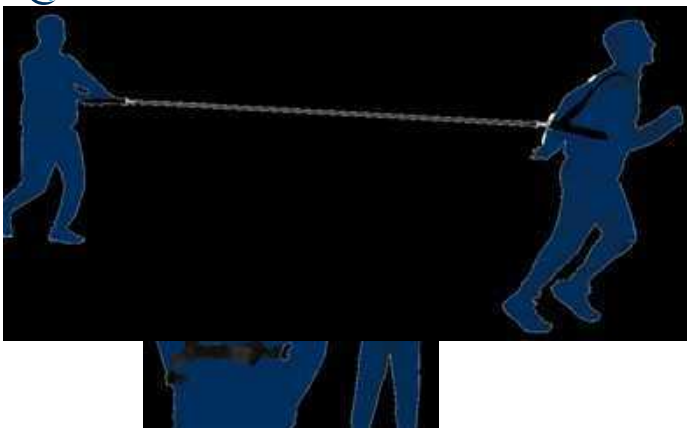

This training harness the most effective method of developing explosive speed and explosive sprint endurance. It is made of resistant nylon and can be used for all sled pulling and speed training. The foam soft handle and comfortable shoulder harness. 3.20 m long strap.

Reference: 062735	Unit
-------------------	------

WEIGHTED SAND BAG

SPORTI



Delivered weighted +



Black vinyl coating bag with 3 reinforced straps of prehension and holding. Identifiable weight on each side of the bag. For physical preparation, the practice of Cross Training and Crossfit.

Reference: 044044	5 kg
Reference: 044045	10 kg
Reference: 044046	15 kg
Reference: 044047	20 kg
Reference: 044048	25 kg

WEIGHTED VEST

SPORTI



Delivered with removable weights +

10 KG

Tricking your body into working out with at a heavier weight lead to better conditioning and increased strength, speed and explosiveness. Add resistance to your workout with adding or removing the provided weights! Features fully adjustable hook and loop straps (10 kg vest) or clips (5 kg vest).

Reference: 062767	5 kg vest (w. 36cm. H. 36cm.)	RECYCLED RECYCLABLE
Reference: 062736	10 kg vest (w. 44cm. H.55cm.)	RECYCLED RECYCLABLE

Sports bags, storage and transport
Multisports
Tracing and ground accessories
Coach, referee and player
First aid
Fitness, bodybuilding and gym
Swimming
Combat sports
Racket sports
Athletics
Balls
School
Nets and accessories

MUSCLE STRENGTHENING

INFLATABLE MEDICINE BALL



Low rebound +



Inflatable medicine ball. Great grip thanks to its rough rubber coating. It will allow you to perform carefully all your bodybuilding and training exercises.

Reference: 021021	1 kg. / Yellow	18 cm. Ø
Reference: 021022	2 kg. / Green	19 cm. Ø
Reference: 021023	3 kg. / Red	22.6 cm. Ø
Reference: 021024	4 kg. / Blue	22.6 cm. Ø
Reference: 021025	5 kg. / orange	23 cm. Ø

FLEXIBLE AND INFLATABLE MEDICINE BALL



Weighted with sand +



Flexible and inflatable medicine ball, perfect for bodybuilding and training exercises. Flexible and enjoyable material for a greater grip.

Reference: 044025	1kg. - Yellow	23 cm. Ø
Reference: 044026	2kg. - Green	23 cm. Ø
Reference: 044027	3kg. - Blue	23 cm. Ø
Reference: 044028	4kg. - Red	23 cm. Ø
Reference: 044029	5kg. - Purple	23 cm. Ø

DOUBLE-HANDED MEDICINE BALL



PVC medicine ball with 2 handles allowing to change hands and thus exercises. Soft and nice touch.

Reference: 021017	4kg. - Yellow	25 cm. Ø
Reference: 021018	6kg. - Green	25 cm. Ø
Reference: 021019	8kg. - Red	25 cm. Ø
Reference: 021020	10kg. - Blue	25 cm. Ø

SEA INFLATABLE GEL MEDICINE BALL



Striped surface



Very flexible, good grip. Multipurpose, inflatable.

Reference: 021050	1 kg. / Yellow	15 cm. Ø
Reference: 021051	2 kg. / Green	17 cm. Ø
Reference: 021052	3 kg. / Red	19 cm. Ø
Reference: 021053	4 kg. / Blue	21 cm. Ø
Reference: 021054	5 kg. / Black	23 cm. Ø

WEIGHTED BALL - 500 G



DIAMETER
13 cm

Water-filled weighted ball for greater softness and flexibility, with a textured, non-slip vinyl coating for better grip and long-lasting use.

Reference: 021055 Unit

WEIGHTED BALL 1 KG



DIAMETER
15 cm

Water-filled weighted ball for greater softness and flexibility, with a textured, non-slip vinyl coating for better grip and long-lasting use.

Reference: 021056 Unit

FITNESS ELASTIC BAND



Central handle of 30 cm +

Delivered with exercises poster +

Woven elastic band available in 7 kg, 10 kg, 15 kg, 20 kg and 30 kg. It has 6 numbered handles of 12 cm and one central handle of 30 cm for a better passage of handles and feet, the elastic measuring more than one meter, you can work with an amplitude from the feet over the arms. Delivered with its instructions poster suggesting more than 40 exercises.

Reference: 044080C	7 kg.	Orange-Black
Reference: 044080	10 kg.	Turquoise-Anthracite
Reference: 044080A	15 kg.	Grey-Turquoise
Reference: 044080B	20 kg.	Anthracite-Turquoise
Reference: 044080D	30 kg.	Black-White

POWER BAND / RESISTANCE ELASTIC BAND



LENGTH 1.04 m THICKNESS 4.5 mm

Resistance band with closed loop. Latex material allowing its elasticity, used for different exercises of muscle-strengthening.

Reference: 044058	Small strength	1.3 cm w.	Blue
Reference: 044059	Medium strength	1.9 cm w.	Grey
Reference: 044060	Strong strength	2.2 cm w.	Black
Reference: 044061	Extra strong strength	2.9 cm w.	Red

FLAT BANDS / SET OF 4 ELASTIC FLAT BANDS



LENGTH 50 cm WIDTH 5 cm

Set of 4 different tension bands delivered in your carry bag and used for muscle-strengthening, Pilates, rehabilitation or during training. Their length of 50 cm (25 cm flat) and their width of 5 cm, bring them a maximum comfort, especially at thighs and ankles level. Colours: yellow, red, blue and green.

Reference: 044030 Set

LATEX STRIP



LENGTH 1.20 m

Latex strip of 15 cm width. It has a very good elasticity and the surface avoids to stick. Recommended for rehabilitation and bodybuilding. 3 available resistances according to the level of difficulty.

Reference: 044004	Light / Turquoise
Reference: 044005	Medium / Grey
Reference: 044006	Strong / Black

GYM TUBE



LENGTH 1.20 m

Latex fitness tube. Perfect to work the muscle-strengthening. It is available in 3 forces: light, medium and strong.

Reference: 044001	Light / Yellow
Reference: 044002	Medium / Blue
Reference: 044003	Strong / Red

SET OF 3 ELASTIC BANDS



LENGTH 31 cm WIDTH 5 cm

Allow to do all training exercises and muscle-strengthening. 3 strengths (light/medium/strong) will help you to adapt exercise according to your capacities. Woven elastic very comfortable that can be used everywhere. Machine washable.

Reference: 044023 Set of 3

Sports bags, storage and accessories
 Multisports
 Tracing and ground accessories
 Coach, referee and player
 First aid
 Fitness, bodybuilding and gym
 Swimming
 Combat sports
 Racket sports
 Athletics
 Balls
 School
 Nets and accessories

SKIPPING ROPES

FITNESS SKIPPING ROPE



+ Adjustable length

RECYCLED
RECYCLABLE
WEIGHT 100 g
LENGTH 2.80 m

Made for a regular training, its moulded handles with a bearing steel give a perfect adhesion and a good movement guaranteeing a constant wobbling. Adjustable length. Handles colour: black.

Reference: 044040B

Unit

WOODEN HANDLES SKIPPING ROPE



LENGTH 2.80 m

Nylon rope for an initiation use. Very robust thanks to its wooden handles.

Reference: 044035

Unit

ANTI-SLIP ALUMINIUM SKIPPING ROPE



+ Length ajustable

RECYCLED
RECYCLABLE
LENGTH 3 m

Anti-slip aluminium handles for a better grip. Steel rope with PVC coating for maximum speed. Ball bearings inside handles. Ideal for cross training. Maximum length: 3 m. Ajustable length. Colour: Black.

Reference: 044039

Unit

WEIGHTED FITNESS SKIPPING ROPE



+ Length ajustable

RECYCLED
RECYCLABLE
LENGTH 2.75 m

Skipping rope with foam ergonomic handles. Adjustable weight thanks to 2 ballasts of 230 g each one. Adjustable length (maximum length 2.75 m).

Reference: 044099

Unit

FLUO SKIPPING ROPES 2.75 M



+ Adjustable length

+ Delivered in a plastic housing

Plastic fluo unicoloured. Available in 4 different colours: Yellow, Blue, Green and Red.

Reference: 044036B

2.75 m

FLUO SKIPPING ROPE 2.20 M



+ Adjustable length

+ Delivered in a plastic housing

Plastic fluo unicoloured. Available in 4 different colours: Yellow, Blue, Green and Red.

Reference: 044089

2.20 m

GYMNASTIC ROPE



DIAMETER 10 mm

Braided rope in bright polypropylene. Colours: Blue / Green / Yellow / Red / Orange.

Reference: 044092A

3 m

Reference: 044092B

5 m

Reference: 044092C

10 m

SET OF 4 INTRODUCTION ROPES



DIAMETER 8 mm

Set of 4 introduction ropes, nylon braided rope for the first jumps. Blue / Green / Yellow / Red.

Reference: 044056

2.5 m

Reference: 044095

3 m

• ROPES



Greater abrasion resistance thanks to its handmade gluing process

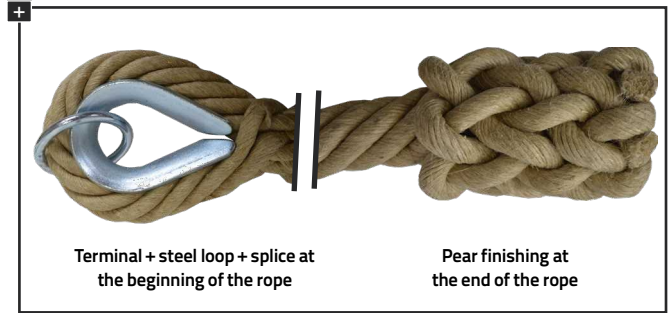

Terminal + steel loop + splice at the beginning of the rope

Pear finishing at the end of the rope

Septain (6 strands + 1 soul):
 - Better catch in hand
 - Better aesthetic result



Length on the request

Smooth rope in natural hemp



Reference	Designation	Diameter
Reference: 060159	Smooth rope in hemp	30 mm
Reference: 060161	Smooth rope in hemp	35 mm
Reference: 060162	Smooth rope in hemp	40 mm

Natural hemp knotted rope



Reference	Designation	Diameter
Reference: 060164	Knotted rope in hemp	22 mm

Sports bags, storage and transport

Multisports

Tracing and ground accessories

Coach, referee and player

First-aid

Fitness, bodybuilding and gym

Swimming

Combat sports

Racket sports

Athletics

Balls

School

Nets and accessories

BOXING

BOXING GLOVES

SPORTI



External material in flexible and very resistant polyurethane. Fastening system of the glove by hook and loop strip and elastic support. Attached thumb anti-reversal. Foam pad. Colour: Blue or Red. Available sizes: 6oz, 8oz, 10oz, 12oz, etc. Sold per pair.

Reference: 059547

Pair

• JUNIOR MULTIBOXE HELMET



WEIGHT 350 g
WIDTH 22 cm
HEIGHT 24 cm

RECYCLED

Foam and PVC material. Adjustable by means of a hook and loop tightening system. Very comfortable. Junior size. Colours: Blue or Red.

Reference: 059551

Unit

FOCUS MITTS

SPORTI



External material in flexible and very resistant polyurethane. Adjustable thanks to the clamp system by Velcro. Support by sewn glove. Sold per pair. Colour: Black.

Reference: 059548

Unit

• PUNCHING PAD



WEIGHT ≈ 610 g
WIDTH 20 cm
HEIGHT 30 cm

RECYCLED
RECYCLABLE

Vinyl covering, high density foam. Hand protection at the handle. The arm is held by a wide elastic.

Reference: 059518

Unit

INTEGRATED 3 PLACES MULTISPORTS PODIUM

SPORTI

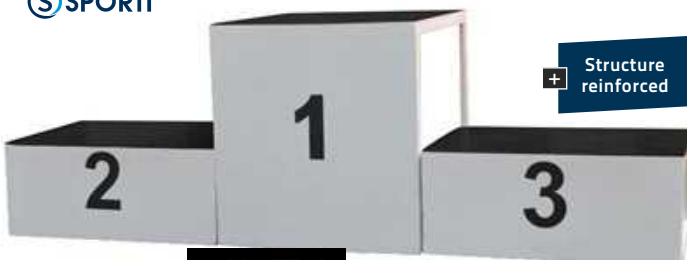

Structure reinforced

Integrated to facilitate storage



OVERALL WEIGHT 27 kg
BOX N°2 AND 3 60 x 48 x 26cm
BOX N°1 66 x 63 x 48 cm

Wooden white podium with white painted iron structure. Black anti-skid rubber surface on the top. Podium n°2 and n°3 could be easily stored in the podium n°1 to be easily transportable and stored. Tip: store your podium inside and avoid moisture.

Reference: 025002

Unit

Reference: 025001

Podium n°3

TATAMIS

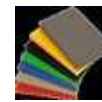

Vinyl

Cotton

MMA



All our Tatamis models are available in different sizes, thicknesses, colours, materials. For any price inquiry and dimensions, please contact us.

For any request, please specify: dimensions, thickness, material, colour, non-skid version or not.

▪ Dimensions :
2000 x 1000 mm
1500 x 1000 mm
1000 x 1000 mm

▪ Thickness :
30 mm
40 mm
50 mm
60 mm

Colours and materials:
Vinyl (Grey, Yellow, Black, Apple green, Blue, Red)
Cotton (Green, Red, Blue, Khaki, Orange)
MMA (Blue, Grey, Red, Black).

• PUZZLE MATS

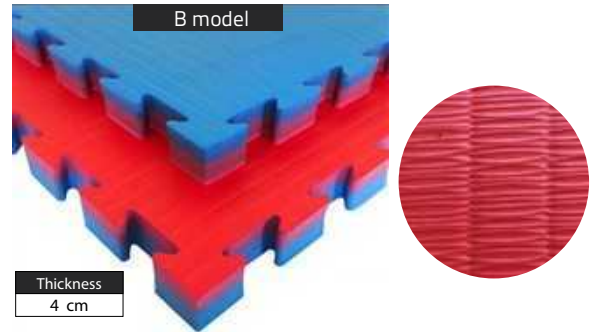
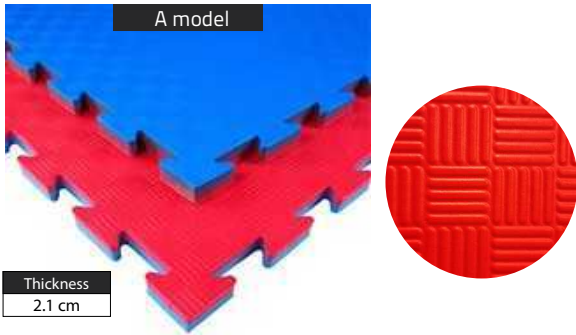

These EVA foam mats are designed for intensive use in gyms, dojos, and combat sports halls. These reversible foams, interlocking 1 m x 1 m mats are ideal for combat sports practise. They create a shock-absorbing, non-slip training surface, ideal for protecting practitioners during falls, throws, or ground training.

A model

Thickness 2.1 cm. Embossed finish. Density 120 kg/m³. Colors: Red/Blue. Suitable for foot and fist sports: Karate, Savate French boxing, Taekwondo.

Reference: 051005 10 m² box
Reference: 051005 10 m² box - from 50 m²

B model

Thickness 4 cm, rice straw finish. Density 90 kg/m³. Colors: Red/Blue. sports involving throwing techniques: Judo, Wrestling, Sambo, Ju-Jitsu, Aikido, Muay Thai, MMA.

Reference: 051006 5 m² box
Reference: 051006 5 m² box - from 50 m²

• KARATE BELT



Roll of 50m +



KARATE BELTS COLOURS

- White / 1 Red line
- White / Yellow
- Yellow / 1 Red line
- Yellow / Orange
- Orange / 1 Red line
- Orange / Green
- Green / 1 Red line
- Green / Blue
- Blue / 1 Red line
- Brown / Blue
- Brown / 1 Red line
- Black / 1 Red line



Strap for karate 100% cotton in roll of 50 m.

Reference: 052001K

• EVOLUTIONARY CHILD KARATE KIMONO

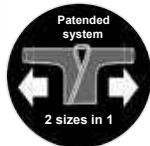

The kimono which grows with your child. Detachable hem to extend the length of jacket and trouser. New canvas micro grain of rice 100% cotton, about 250 g/m². Woven strips gradation. Supplied without belt.

- Reference: 051012 90/100 size
- Reference: 051012 100/110 size
- Reference: 051012 110/120 size
- Reference: 051012 120/130 size
- Reference: 051012 130/140 size
- Reference: 051012 140/150 size
- Reference: 051012 150/160 size

• JUDO BELT



Roll of 50m +



JUDO BELTS COLOURS

- White
- White / 1 Yellow line
- White / 2 Yellow lines
- White / Yellow
- Yellow
- Yellow / Orange
- Orange
- Orange / Green
- Green
- Green / Blue
- Blue
- Blue / Brown
- Red
- Brown
- Black



Strap for judo 100% cotton in roll of 50 m.

Reference: 052001J

• EVOLUTIONARY CHILD JUDO KIMONO

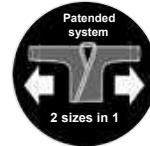

The kimono which grows with your child. Detachable hem to extend the length of jacket and trouser. Canvas 100% smooth cotton, about 180 g/m². Supplied without belt.

- Reference: 051013 90/100 size
- Reference: 051013 100/110 size
- Reference: 051013 110/120 size
- Reference: 051013 120/130 size
- Reference: 051013 130/140 size
- Reference: 051013 140/150 size
- Reference: 051013 150/160 size



Sports bags, storage and transport
Multisports
Tracing and ground accessories
Coach, referee and player
First aid
Fitness, bodybuilding and gym
Swimming
Combat sports
Racket sports
Athletics
Balls
School
Nets and accessories

PAIR OF CLUBS

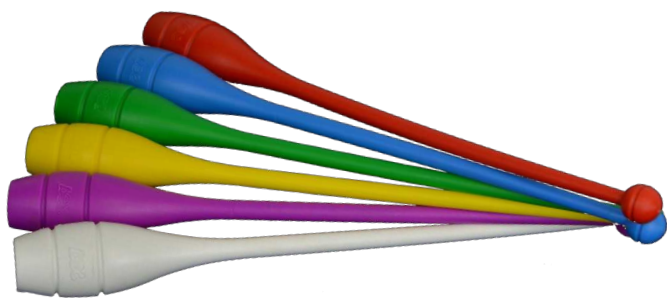

Pair of clubs, plastic material. Made for trainings. Available in White, Blue, Yellow, Red, Green and Purple.

Reference: 033120	Introduction	90 gr / 34 cm L.
Reference: 033121	Training	110 gr / 41 cm L.
Reference: 033122	Competition	160 gr / 45 cm L.

SET OF 5 TRAINING BALLS



WEIGHT	DIAMETER
100 g	18 cm

Early learning balls that can be blown up again in flexible and light bright plastic, to throw and roll it with one or two hands. Matching colours.

Reference: 033139 Set of 5

TRAINING BALL



WEIGHT	DIAMETER
300 g	16 cm

Ball in bright plastic with rubber valve, gloss finish. Available in 4 colours.

Reference: 033137 Unit

COMPETITION BALL



WEIGHT	DIAMETER
420 g	19 cm

Ball in bright plastic with rubber valve, gloss finish. Available in 4 colours.

Reference: 033138 Unit

STIMULATION RIBBON



WIDTH	LENGTH
4 cm	1.60 m

Available in 6 colours: Green, Yellow, Blue, Orange, Purple and Red.

Reference: 033117 1.6 m

TRAINING RIBBON

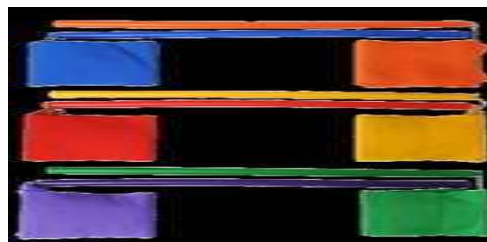

LENGTH
4 m

Available in 6 colours: Green, Yellow, Blue, Orange, Purple and Red.

Reference: 033140 4 m

WOODEN STICK



24 mm

Turned and polished wooden stick, used for indoor warm-up. Available in 4 lengths.

Reference: 033115A	L. 80 cm	Unit
Reference: 033115B	L. 100 cm	Unit
Reference: 033115C	L. 120 cm	Unit
Reference: 033115E	L. 140 cm	Unit

Sports bags, storage and transport
Multisports
Tracing and ground accessories
Coach, referee and player
First aid
Fitness, bodybuilding and gym
Swimming
Combat sports
Racket sports
Athletics
Balls
School
Nets and accessories



Swimming

Swind textile, caps and goggles 128
Accessories and training equipment 129

TO DISCOVER



P.129



P.130



P.130



GIRLS SWIMSUITS



Composition: 80% polyamide, 20% elastane. Available colour: Black/Pink (4/6 - 6/8 - 8/10 - 10/12 - 12/14 years old).

Reference: 041073

WOMEN'S SWIMSUITS



Composition: 80% polyamide, 20% elastane. Available sizes: 36/38 - 38/40 - 40/42 - 42/44 - 44/46. Available colour: Black/Pink.

Reference: 041071

MEN'S SWIM BOXER



Composition: 80% polyamide, 20% elastane. Available sizes: S - M - L - XL - XXL. Available colour: Black/Orange.

Reference: 041074

MEN'S SWIM BOXER



Composition: 80% polyamide, 20% elastane. Available sizes: S - M - L - XL - XXL. Available colour: Black/Orange.

Reference: 041077

• MEN'S SWIM TRUNKS



Composition: 80% polyamide, 20% elastane. Available sizes: M - L - XL. Available colour: Black/Orange.

Reference: 041076

POLYESTER SWIMMING CAP FOR KIDS

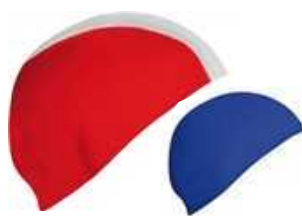

Double layer 100% polyester swimming cap. Reinforced elastic for a better hold. Available colours: Royal blue - Red striped white.

Reference: 041091 Unit

POLYESTER SWIMMING CAP



Polyester swimming cap reinforced for a better hold. Available colours: Midnight blue - Black striped blue.

Reference: 041088 Unit

SILICONE SWIMMING CAP 33 G



Silicone swimming cap 33g. Available colours: Blue - White - Black - Red.

Reference: 041090 Unit

SILICONE SWIMMING CAP 51 G



Silicone swimming cap 51g. Available colours: Blue - Black.

Reference: 041089 Unit

STANDARD SWIMMING GOGGLES FOR KIDS



Silicone eye contour and elastic. Adjustable nose pad. Available colour: Blue.

Reference: 041086 Unit

TRAINING SWIMMING GOGGLES FOR CHILD



Silicone eye contour and elastic. Anti-fog treatment, monobloc goggles. Available colours: Orange / Black and Green / Blue.

Reference: 041084 Unit

STANDARD SWIMMING GOGGLES



With easy adjustment. Silicone eye contour, silicone elastic, adjustable nose pad. Available colour: Transparent.

Reference: 041082 Unit

TRAINING SWIMMING GOGGLES



Eye contour and silicone elastic. Anti-fog treatment, monobloc goggles. Matching colours (Black or Grey).

Reference: 041081 Unit

CHILD BELT



Float 3-6 years old	
Thi	5 cm
w.	6 cm
L.	12 cm

Float 6-12 years old	
Thi	5 cm
w.	7 cm
L.	14 cm

RECYCLABLE

Swimming belt composed of removable floats in high buoyancy foam, mounted on strap with clip. 5 removable floats for belt 3-6 years and 6 removable floats for belt 6-12 years.

Reference: 041011 3-6 years old orange / dark blue
Reference: 041012 6-12 years old blue / white

AQUA JOGGING BELT



Float	
Thi	35 mm
w.	22 cm
L.	74 cm

RECYCLABLE

Aquatic belt with monobloc float ensuring the vertical stability in the water. It is suitable for persons of + 70 kg.

Reference: 042003 Unit

TRAINING SWIMMING BOARD



RECYCLABLE		
LENGTH	WIDTH	HEIGHT
43 cm	27 cm	3.8 cm

Flexible swimming board with a good catch in hand. In PE foam, it has an anatomic shape.

Reference: 041010 Unit

PULL BUOY

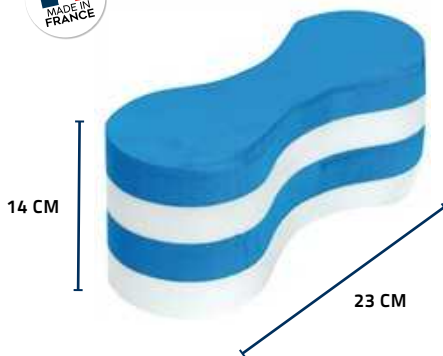

RECYCLABLE	
WIDTH	HEIGHT
23 cm	14 cm

Foam pull buoy. Perfect for working the arms. Unit. Matching colours.

Reference: 041007 Unit

POOL NOODLE

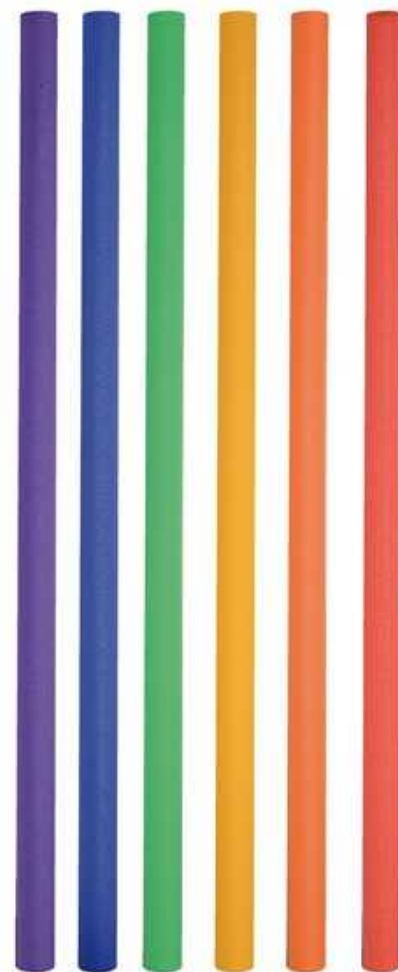

RECYCLABLE	
DIAMETER	LENGTH
6.5 cm	160 cm

Swimming noodle in expandable polystyrene. 6 different colours (Yellow, Red, Blue, Purple, Orange or Green).

Reference: 041036 Unit

• AQUASTEPPER



RECYCLABLE		
LENGTH	WIDTH	HEIGHT
67 cm	35 cm	19 cm

Polypropylene step specially designed for the aqua fit and fitness in an aquatic environment. Equipped with 8 silicone suckers, it sticks perfectly to all swimming pool smooth bottoms. Possibility to ballast the step if the suckers are not enough (for example if the swimming pool bottom is made with little mosaic tiles).

Reference: 044100 Unit



SHORT SWIMMING FINN



RECYCLABLE

Short swimming fins for sports swimming. Ideal for swimming sessions. Easy to put on, extreme comfort and excellent support. Size adjustment on the side and at the back. Allows you to move forward faster. 100% silicone. Blue and black colours. Available in 2 sizes: S (34-38) / L (44-48).

Reference: 041113 Pair

SWIMMING ACCESSORIES

WATER POLO FLOATING GOAL

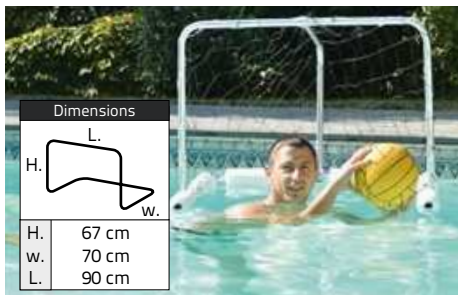

Floating structure in aluminium tube with floats and net.

Reference: 041044 Unit

WATER-POLO BALL



WEIGHT
450 g

RECYCLABLE
DIAMETER
21 cm

Rubber water polo ball. Ideal for initiation, training and schools. Size 5.

Reference: 041049 Unit

POOL BASKETBALL HOOP



Basket
∅ 46 cm

RECYCLABLE
DIAMETER
64 cm

RECYCLABLE
HEIGHT
52 cm

PVC water basketball goal. Tubes structure in flexible plastic with foam float and net.

Reference: 041046 Unit

SWIMMING ARMBANDS



Armbands with valve anti-rejection air.

Reference: 041093

EARPLUGS



Storage case +

Silicon earplugs with storage case.

Reference: 041101

NOSE CLIP



Storage case +

Flesh-coloured nose clip, with storage case.

Reference: 041097

SET OF 6 WEIGHTED DISCUS



Set of 6 perforated and numbered discs. Of different colours, they include a weight on one side in order to submerge them quickly.

Reference: 041032 Set

SET OF 5 WEIGHTED RINGS



Set of 5 weighted rings of soft snorkelling. Numbered and of different colours, they include a weight on one side in order to submerge them quickly.

Reference: 041034 Set

SET OF 5 WEIGHTED DIVING STICKS



Set of 5 weighted diving sticks, of different colours and numbered. In PVC material.

Reference: 041033 Set

SET OF 4 WEIGHTED HOOPS

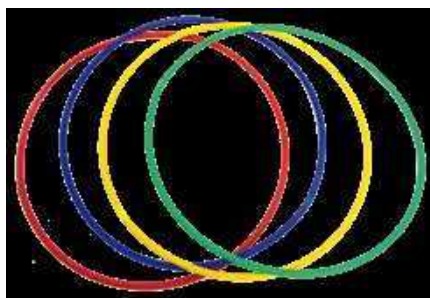

RECYCLABLE
DIAMETER
72 cm

Set of 4 weighted hoops of 4 different colours. The hoops hold vertically on the bottom of the pool.

Reference: 041035 Set

• 4-HAND POOL TIMER FOR SWIMMING



WIDTH
80 cm

HEIGHT
80 cm

Asynchronous motor with extreme precision. Fibreglass frame, resistant to corrosion and chlorine. Metal hands in 4 different colours orange, blue, red, green; allowing 4 swimmers to time their race independently. Power supply.

Reference: 024027 Set



Racket sports

Pickleball	132
Table Tennis	136
Badminton	138
Badminton, beachbadminton and speedbadminton	140
Tennis	141
Trolley for balls and mini-tennis kit	144

TO DISCOVER



P.132



P.138



P.144

KID PICKLEBALL RACKET

2026 NEW Available at the end of March 2026



+ Ultra spin technology

WEIGHT	175 gr	THICKNESS	10.5 mm
WIDTH	18.2 cm	HEIGHT	35.5 cm



Beginner fiberglass racket, very lightweight with excellent grip. Ideal for introducing pickleball to children up to 8 years old. Features **Ultra Spin** technology for smoother backhand/forehand transitions. A protective edge strip extends the racket's lifespan.

Reference: 013019

WOOD PICKLEBALL RACKET



+ Ultra spin technology

WEIGHT	330 gr	THICKNESS	10 mm
WIDTH	19.7 cm	HEIGHT	40.2 cm



This racket is fitted with a protective rim to protect against the scratches and ground impacts. This protection increases its lifespan and the handle has a PU grip allowing a good grip and greater playing comfort. This racket also features **Ultra Spin** technology making it easier to switch from backhand to forehand thanks to a perfect balance and an easier rotation. Wood material.

Reference: 013000

FIBREGLASS PICKLEBALL RACKET



+ Ultra spin technology

+ Technical buffer

WEIGHT	240 gr	THICKNESS	16 mm
WIDTH	19.8 cm	HEIGHT	40.4 cm



This racket is fitted with a protective rim to protect against the scratches and ground impacts. This protection increases its lifespan and the handle has a PU grip allowing a good grip and greater playing comfort. This racket also features below technologies: **Ultra Spin**: making it easier to switch from backhand to forehand thanks to a perfect balance and an easier rotation. **Technical Buffer**: allows to reduce vibrations to improve playing comfort and performances. Fiberglass material, polypropylene core.

Reference: 013001

CARBON PICKLEBALL RACKET

2026 NEW



+ Ultra spin technology

+ Technical buffer

WEIGHT	205 gr	THICKNESS	16 mm
WIDTH	19 cm	HEIGHT	41.5 cm



High-performance carbon fiber racket with polypropylene core designed to deliver maximum power. Features **Ultra Spin** technology for smoother backhand/forehand transitions and **Buffer Technique** to reduce vibrations. A protective edge strip extends the racket's lifespan.

Reference: 013017

SET OF 3 INDOOR BALLS



Set of 3 balls of 74 mm diameter with 26 holes made for an indoor use. Sold with a mesh net to carry it. Material: PE. Colour: Neon green.

Reference: 013002 Set of 3

SET OF 3 OUTDOOR BALLS



Set of 3 balls of 74 mm diameter with 40 holes made for an indoor use. Sold with a mesh net to carry it. Material: PE. Colour: Neon yellow.

Reference: 013003 Set of 3

SET OF 24 OUTDOOR PICKLEBALL BALLS

2026 NEW



Set of 24 balls, 74 mm in diameter with 40 holes, designed for outdoor use. Includes a mesh transport bag. Material: Polyethylene. Colour: Neon Yellow.

Reference: 013018 Set of 24

SINGLE LINE



MARKING «T»



Available in April 2026

MARKING «L»



Available in April 2026



WIDTH 7.5 cm
LENGTH 35 cm

Single line for pickleball court
Colour: Yellow.

Reference: 069103



WIDTH 6 cm
HEIGHT 27 cm
LENGTH 27 cm

Marking only «T» for pickleball court
Colour: Yellow.

Reference: 013020



WIDTH 6 cm
HEIGHT 27 cm
LENGTH 27 cm

Marking only «L» for pickleball court
Colour: Yellow.

Reference: 013021

PICKLEBALL GROUND MARKER SET

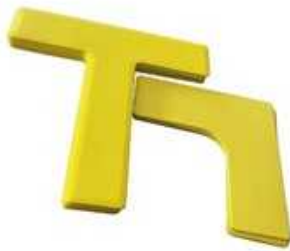

Roller tape measure included

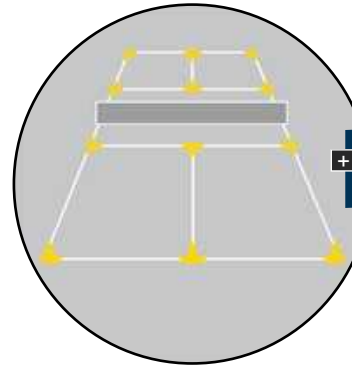

8 T markers + 4 L markers

Ground marker set that turns any surface into a pickleball pitch thanks to its non-slip material. The set includes 8 markers in T shape (27 x 27 cm) and 4 in L shape (27 x 27 cm). Supplied with 10m of measuring tape with reel to help you in the setting up. Colour: Yellow.

Reference: 013004

COACH CLIPBOARD PICKLEBALL/BADMINTON



COACH CLIPBOARD TENNIS/PADDLE

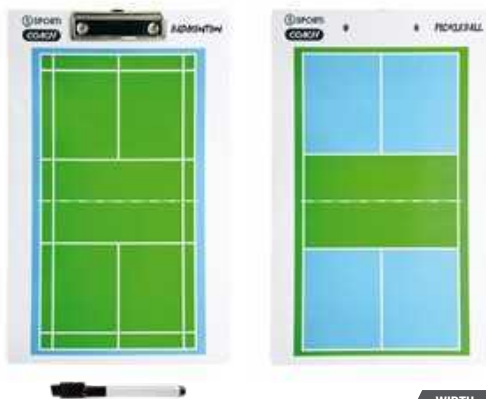

RECYCLED RECYCLABLE
WIDTH 22.5 cm
HEIGHT 36 cm

Rigid wipe-clean PVC board with metal clip. One side features a Badminton court, the other a Pickleball court. Supplied with a marker.

Reference: 063192

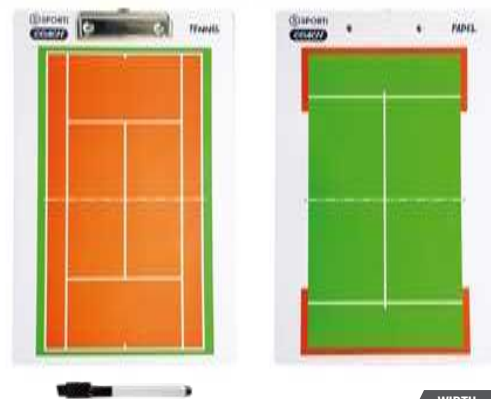

RECYCLED RECYCLABLE
WIDTH 22.5 cm
HEIGHT 36 cm

Rigid wipe-clean PVC board with metal clip. One side features a Tennis court, the other a Paddle court. Supplied with a marker.

Reference: 063191

MESH PICKLEBALL BAG



RECYCLABLE
WIDTH 30 cm HEIGHT 56 cm

210D mesh pickleball bag with a shoulder strap allowing to transport 2 rackets and 3 balls. Hook and loop fastener. Colour: Black.

Reference: 013005

CLUB PICKLEBALL BAG



RECYCLED RECYCLABLE
THICKNESS 10 mm WIDTH 28 cm HEIGHT 50 cm

300D polyester pickleball bag with front mesh storage pocket and shoulder strap for carrying 2 rackets and 3 balls. Zipped fastening. Colour: Black.

Reference: 013006

PICKLEBALL NET



+ Official dimensions

RECYCLED RECYCLABLE
WIDTH 6.70 m HEIGHT 91 cm

Pickleball net designed for a quick, easy and tool-free assembly. Its steel posts and its knotless 2.2 mm polyester net with 40 mm mesh make it a robust and durable structure. Official dimensions: 6.70 m w. x 91 cm H. Supplied with a carrying bag.

Reference: 013007

Pickleball net

Reference: 013008

Spare net for 013007

Reference: 013009

Bag for 013007

INDOOR WOOD PICKLEBALL KIT

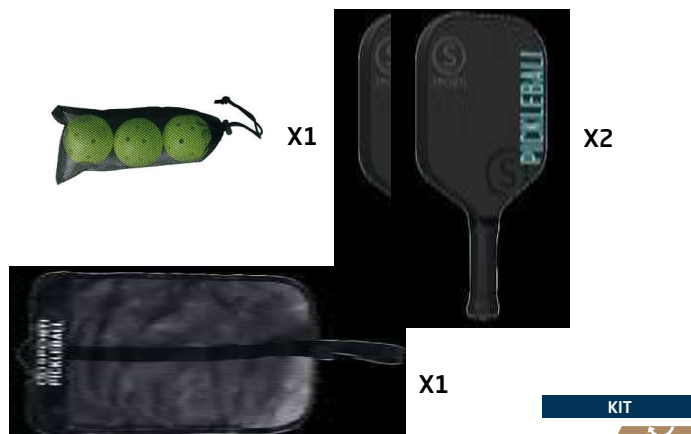

KIT RECYCLABLE

Pickleball kit composed of 2 wood rackets ref 013000 + 1 mesh bag ref 013005 + 1 set of 3 indoor balls ref 013002.

Reference: 013010

OUTDOOR WOOD PICKLEBALL KIT



KIT RECYCLABLE

Pickleball kit composed of 2 wood rackets ref 013000 + 1 mesh bag ref 013005 + 1 set of 3 indoor balls ref 013003.

Reference: 013011

INDOOR FIBREGLASS PICKLEBALL KIT

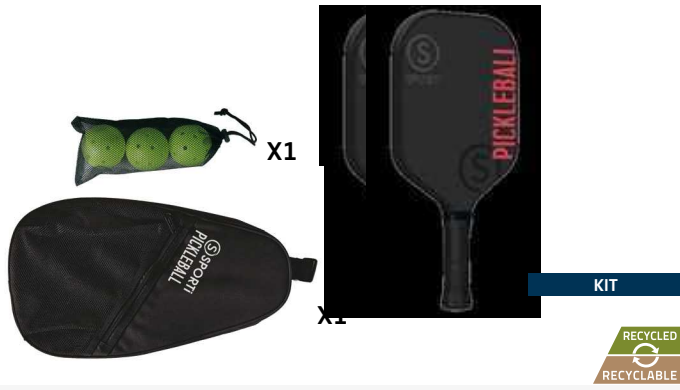

Pickleball kit composed of 2 fibreglass rackets ref 013001 + 1 CLUB bag ref 013006 + 1 set of 3 indoor balls ref 013002.

Reference: 013012

OUTDOOR FIBREGLASS PICKLEBALL KIT



Pickleball kit composed of 2 fibreglass rackets ref 013001 + 1 CLUB bag ref 013006 + 1 set of 3 outdoor balls ref 013003.

Reference: 013013

PICKLEBALL COURT KIT

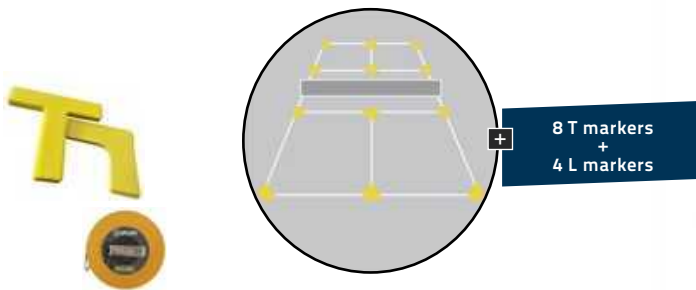

Kit composed of a Pickleball net ref 013007 + 1 floor marking set ref 013004.

Reference: 013014



WOOD PICKLEBALL COMPLETE KIT



Kit composed of a net ref 013007 + 1 marking set ref 013004 + 4 wooden rackets ref 013000 + 1 set of 3 indoor balls ref 013002 + 1 set of 3 outdoor balls 013003 + 2 mesh bags ref 013005.

Reference: 013015

FIBREGLASS PICKLEBALL COMPLETE KIT



Kit composed of a net ref 013007 + 1 marking set ref 013004 + 4 fibreglass rackets ref 013001 + 1 set of 3 indoor balls ref 013002 + 1 set of 3 outdoor balls 013003 + 2 club bags ref 013006.

Reference: 013016

Sports bags, storage and transport

Multisports

Tracing and ground accessories

Coach, referee and player

First aid

Fitness, bodybuilding and gym

Swimming

Combat sports

Racket sports

Athletics

Balls

School

Nets and accessories

TABLE TENNIS

TOPSPIN PADDLE ★



Paddle to use for beginner and leisure, coating with outside pimples.

Reference: 014055

Unit

TOPSPIN PADDLES KIT ★



KIT

x 20



Set of 20 Topspin paddles + 1 paddle bag ref 014043.

Reference: 014049

Kit

SHOOTER PADDLE ★★



Paddle to use at school and to learn playing ping-pong, coating with inside pimples and foam 1.5 mm. 1 red side and 1 black side.

Reference: 014056

Unit

SHOOTER PADDLES KIT ★★



KIT

x 20



Set of 20 Shooter paddles + 1 paddle bag ref 014043.

Reference: 014050

Kit

FIGHTER PADDLE ★★★



Paddle to use at school and in the clubs, coating with inside pimples and foam 1.8 mm.

Reference: 014054

Unit

FIGHTER PADDLES KIT ★★★



KIT

x 20



Set of 20 Fighter paddles + 1 paddles bag ref 014043.

Reference: 014051

Kit

HURRICANE PADDLE ★★★★



Dynamic paddle perfect for first steps in club, coating with inside pimples and foam 1.8 mm. Certified paddle ITTF.

Reference: 014058

Unit

HURRICANE PADDLES KIT ★★★★



KIT

x 20



Set of 20 Hurricane paddles + 1 paddles bag ref 014043.

Reference: 014052

Kit

SHOOTER COLLECTIVITIES PACK ★★



Pack composed of 12 SHOOTER paddles with carry bag + 1 bag of 100 balls.
 Reference: 014048 Collectivities pack
 Reference: 014064 Carry bag only



FIGHTER COLLECTIVITIES PACK ★★★



Pack composed of 12 FIGHTER paddles with carry bag + 1 bag of 100 balls.
 Reference: 014065 Collectivities pack
 Reference: 014064 Carry bag only



SET SHOOTER ★★



Set composed of 2 SHOOTER paddles and 2 balls. Delivered in its carrying bag.

Reference: 014079 Set



SET FIGHTER ★★★



Set composed of 2 FIGHTER paddles and 2 balls. Delivered in its carrying bag.

Reference: 014078 Set



PVC PADDLE

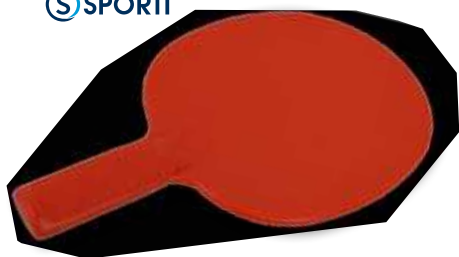

Ping-pong paddle perfect for beginners. High density polyethylene structure for an unbreakable and water resistant racket. Red colour.

Reference: 014083 Unit



BOX OF 6 BALLS ★★



Ball
 Ø 40 mm

ABS material. Diameter of 40 mm.

Reference: 014053 White
 Reference: 014060 Orange



BAG OF 100 BALLS



Ball
 Ø 40 mm

ABS material. Diameter of 40 mm.

Reference: 014061 White
 Reference: 014062 Orange



POSTS / NETS



Fixing of the table with heavy-duty clips. Its net is in black nylon with white strap. Fixed height of the net. Delivered on blister pack.

Réf : 014044 Posts and net



PVC FOLDABLE SCORER



Folded dim
 w. 20 cm
 L. 38 cm

Numbering of the points: 2 sets composed of numbers from 0 to 31 and 2 sets from 0 to 7.

Reference: 014080 Unit



BAG FOR TABLE TENNIS PADDLES



Reinforcement strap

Compartment for paddles

Compartment for balls

LENGTH 62 cm
 WIDTH 26 cm
 HEIGHT 26 cm

Nylon canvas bag reinforced 600 deniers. It is composed of a large main compartment with an opening in U to easily store until 40 table tennis paddles. Front pocket with a zip for the storage. Adjustable and reinforced handles and transport shoulder strap. Colour: black. Delivered without paddle and without ball/shuttlecock.

Reference: 014043 Unit

Sports bags, storage and transport
 Multisports
 Training and ground accessories
 Coach, referee and player
 First-aid
 Fitness, bodybuilding and gym
 Swimming
 Combat sports
 Racket sports
 Athletics
 Balls
 School
 Nets and accessories

Find all our badminton nets on page 191

SPORTi



RACKETS

Model	(1) SCHOOL 53	(2) SCHOOL 58	(3) DISCOVERY 61	(4) DISCOVERY 66	(5) HARD TRAINING	(6) EVOLUTION
Length	53 cm	58 cm	61 cm	66 cm	66 cm	66 cm
Frame	Aluminium	Aluminium	Steel	Steel	Aluminium	Aluminium
Shaft	Steel	Steel	Steel	Steel	Steel	Graphite
Weight	94 g	98 g	110 g	110 g	100 g	95 g
Grip and string	Polyurethane grip and multifilament strings					
Throat	Reinforced	Reinforced	Reinforced	Reinforced	Reinforced	Integrated
Age	6 - 10	8 - 12	8 - 12	12+ and SENIOR	12+ and SENIOR	12+ and SENIOR
Reference	Reference: 011069	Reference: 011070	Reference: 011071	Reference: 011072	Reference: 011073	Reference: 011075

TUBE OF 6 SCHOOL SHUTTLECOCKS



Resistant and with a good flying quality, this shuttlecock is perfect for discovering badminton. Nylon shuttlecock and foam head.

Reference: 011077

TUBE OF 6 FOAM BASE SHUTTLECOCKS FOR INTRODUCTION

SPORTi



Speed adapted to beginners. Foam base and nylon shuttlecock.

Reference: 011041 White

TUBE OF 6 TRAINING SHUTTLECOCKS

SPORTi



Medium speed. Cork head and nylon shuttlecock.

Reference: 011078 White
Reference: 011086 Neon Yellow

Find all our badminton nets on page 191

20 SCHOOL 53 RACKETS KIT



KIT



Set of 20 SCHOOL 53 rackets + 1 rackets bag ref 011084.

Reference: 011030

Kit

20 SCHOOL 58 RACKETS KIT



KIT



Set of 20 SCHOOL 58 rackets + 1 rackets bag ref 011084.

Reference: 011031

Kit

20 DISCOVERY 61 RACKETS KIT



KIT



Set of 20 DISCOVERY 61 rackets + 1 rackets bag ref 011084.

Reference: 011032

Kit

20 DISCOVERY 66 RACKETS KIT



KIT



Set of 20 DISCOVERY 66 rackets + 1 rackets bag ref 011084.

Reference: 011033

Kit

20 HARD TRAINING RACKETS KIT



KIT



Set of 20 HARD TRAINING rackets + 1 rackets bag ref 011084.

Reference: 011034

Kit

20 EVOLUTION RACKETS KIT



KIT



Set of 20 EVOLUTION rackets + 1 rackets bag ref 011084.

Reference: 011035

Kit

BAG FOR BADMINTON RACKETS



Compartment for shuttlecocks



Reinforcement strap

LENGTH 80 cm WIDTH 48 cm HEIGHT 33 cm

Nylon canvas bag reinforced 600 deniers. It is composed of a large main compartment with an opening in U to easily store until 40 badminton rackets. Side pocket with an opening in U to store the tubes for shuttlecocks (until 10 tubes). Handles and transport adjustable and reinforced shoulder strap. Colour: black. Delivered without racket and ball.

Reference: 011084

Unit

COACH CLIPBOARD PICKLEBALL/BADMINTON

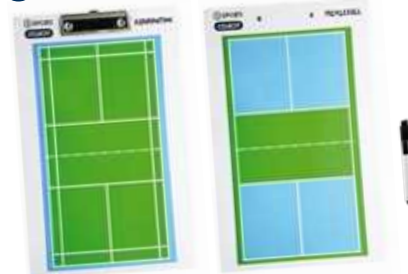

WIDTH 22.5 cm HEIGHT 36 cm

Rigid wiper-clean PVC board with metal clip. One side features a Badminton court, the other a Pickleball court. Supplied with a marker.

Reference: 063192

Sports bags, storage and transport
Multisports
Tracing and ground accessories
Coach, referee and player
First-aid
Fitness, bodybuilding and gym
Swimming
Combat sports
Racket sports
Athletics
Balls
School
Nets and accessories

FOLDABLE BADMINTON SET

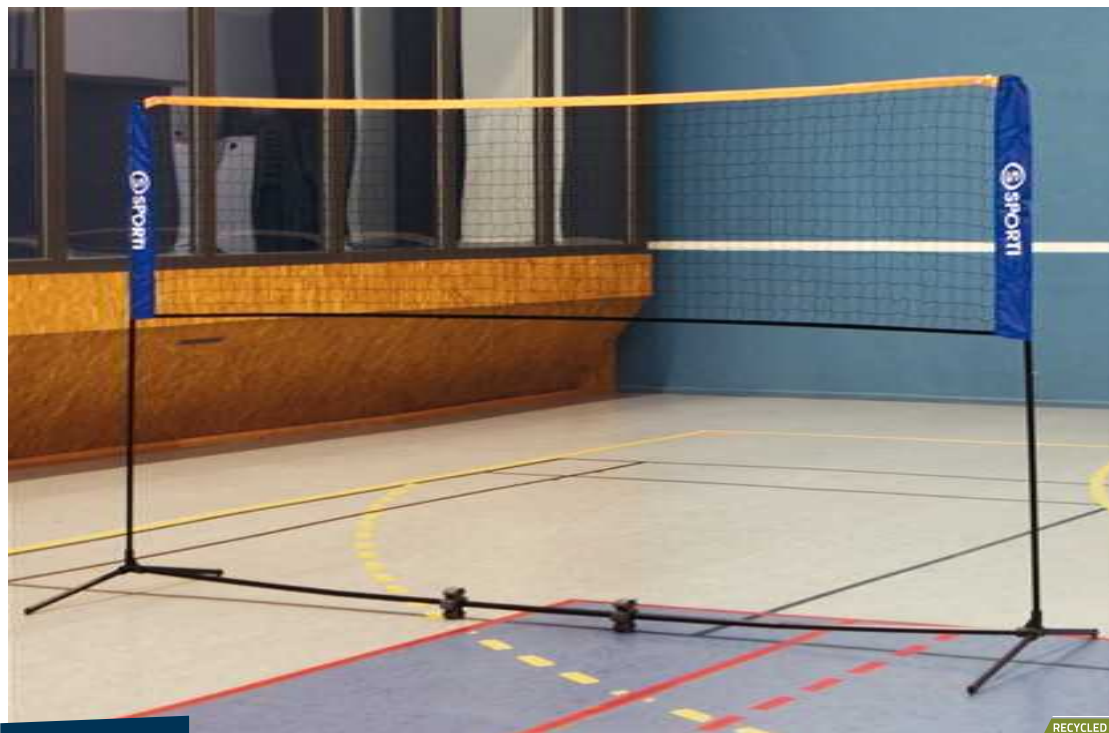

+ Practical & easy to install

RECYCLED RECYCLABLE
LENGTH 3 m
HEIGHT 1.50 m

Very stable thanks to its large base and its structure in steel tube of 19 mm diameter. Very practical and easy to install, this set will be assembled and dismantled in only 2 minutes. Delivered with PE net 2 mm and carrying bag.

Reference: 011044

Unit

• SPEED 4400 SPEEDBADMINTON SET



This set is composed of 2 aluminium rackets (54.5 cm / 165 gr.) and 3 shuttlecocks (1 slower «STARTER» shuttlecock and 2 faster «RACER» shuttlecocks).

Reference: 015006

• SPEED 2200 BEACHMINTON SET



This set is composed of 2 aluminium badminton rackets (54.5 cm / 105 gr.) and 3 shuttlecocks (1 slower «STARTER» shuttlecock and 2 faster «RACER» shuttlecocks).

Reference: 015007

• TUBE OF 6 SPEEDBADMINTON SHUTTLECOCKS



Tube of 6 Speedbadminton shuttlecocks composed of 4 faster «RACER» shuttlecocks and 2 slower «STARTER» shuttlecocks.

Reference: 011085

Sports bags, storage and transport
 Multisports
 Tracing and ground accessories
 Coach, referee and player
 First aid
 Fitness, bodybuilding and gym
 Swimming
 Combat sports
 Racket sports
 Athletics
 Balls
 School
 Nets and accessories

• TENNIS BALL STAGE 1

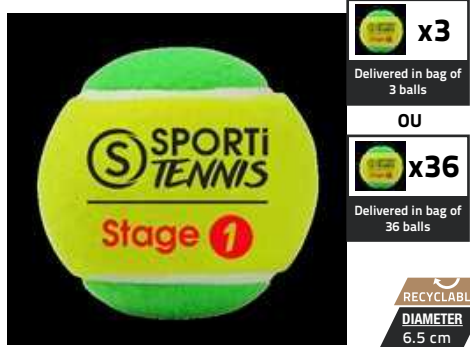

x3
Delivered in bag of 3 balls

OU

x36
Delivered in bag of 36 balls

RECYCLABLE
DIAMETER 6.5 cm

The ball Stage 1 has the same size than a standard tennis ball but with a rebound and a speed slightly lower. It is adapted to the Galaxy Tennis programme "Green" level for children from 9 years old. Material: felt.

Reference: 012076 Set of 3
Reference: 012051 Set of 36

• TENNIS BALL STAGE 2



x3
Delivered in bag of 3 balls

OU

x36
Delivered in bag of 36 balls

RECYCLABLE
DIAMETER 6.5 cm

The ball stage 2 has the same size than a standard tennis ball but with a small rebound. It is adapted to the Galaxy Tennis programme "Orange" level for children from 7 years old.

Reference: 012072 Set of 3
Reference: 012052 Set of 36

• TENNIS BALL STAGE 3

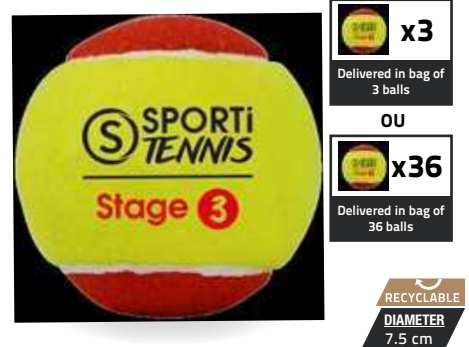

x3
Delivered in bag of 3 balls

OU

x36
Delivered in bag of 36 balls

RECYCLABLE
DIAMETER 7.5 cm

The ball Stage 3 is biggest and less rapid than a standard tennis ball. It is adapted to the Galaxy Tennis programme "Red" level for children from 6 years old. Material: felt.

Reference: 012071 Set of 3
Reference: 012053 Set of 36

• TENNIS BALLS FOR CLUB - BUCKET OF 36 BALLS



Bucket of 36 tennis balls without pressure, training.

Reference: 012077 Bucket of 36 balls

• TENNIS BALL FOR CLUB - TUBE OF 3



Tube of 3 training pressurized tennis balls.

Reference: 012070 Tube of 3 balls

BALL	AGE	SPEED	Ø	REBOUND
Club	> 14	██████████	6.5 cm	
Stage 1	9-14	██████████	6.5 cm	
Stage 2	7-11	██████████	6.5 cm	
Stage 3	6-9	██████████	7.5 cm	

FOAM BALL

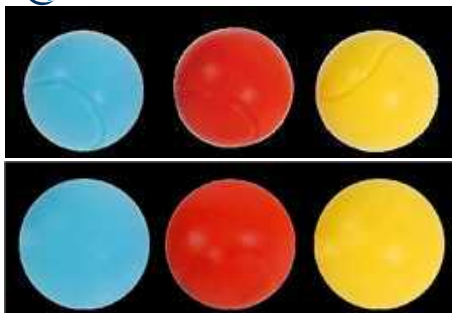

Polyurethane foam balls for introduction to all racket games.

Reference: 099241 Unit - 7 cm ball
Reference: 099370 Set of 24 balls 7 cm
Reference: 099242 Unit - 9 cm ball
Reference: 099371 Set of 20 balls 9 cm

• GALAXY TENNIS BALL 15CM DIAMETER - PURPLE



RECYCLABLE
DIAMETER 15 cm

PVC ball adapted to the Galaxy Tennis programme "Purple" for children from 4 years old. Its size and rebound allow children to play and have fun quickly.

Reference: 012102 Unit

ULTRA-LIGHT BALLS WITH STRAW FOR TENNIS



Delivered with straw + nozzle

RECYCLABLE
WEIGHT 115 g
DIAMETER 26 cm

Flexible and very light PVC ball, without phthalate, inflatable with the mouth and with a straw + a nozzle to close the ball. White colour. Ball adapted to the Galaxy Tennis programme "White" level for children from 4 years old.

Reference: 099368 Unit

Sports bags, storage and transport
Multisports
Tracing and ground accessories
Coach, referee and player
First-aid
Fitness, bodybuilding and gym
Swimming
Combat sports
Racket sports
Athletics
Balls
School
Nets and accessories

Find all our tennis nets on page 190

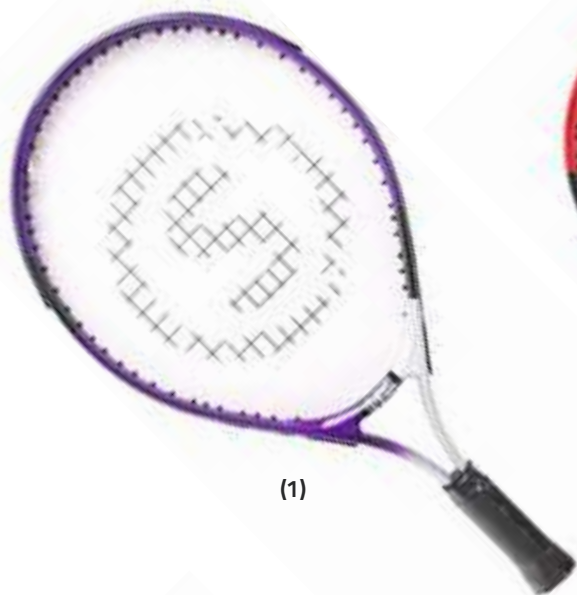

(1)



(2)



(3)



(4)

JUNIOR RACKETS

Model	(1) JR T500 19"		(2) JR T600 21"	(3) JR T700 23"	(4) JR T800 25"
Length	49 cm		53 cm	58 cm	63 cm
Material	Aluminium		Aluminium	Aluminium	Aluminium
Grip size	0		1	1	2
Age	4 - 7 years old		6 - 9 years old	7 - 11 years old	9 - 14 years old
Player size	< 116 cm		116 to 128 cm	128 to 140 cm	140 to 152 cm
«Galaxy Tennis» level	White	Purple	Red	Orange	Green
Adapted ball	Ultra-light straw ball Page 141	Purple ball 15cm Ø Page 141	Stage 3 Page 141	Stage 2 Page 141	Stage 1 Page 141
Reference	Reference: 012064		Reference: 012062	Reference: 012063	Reference: 012065

Sports bags, storage and transport
Multisports
Tracing and ground accessories
Coach, referee and player
First aid
Fitness, bodybuilding and gym
Swimming
Combat sports
Racket sports
Athletics
Balls
School
Nets and accessories

Find all our tennis nets on page 190

10 RACKETS KIT JR T500 19"



Set of 10 rackets JR T500 19" + 1 rackets bag ref 011084.

Reference: 012058

Kit

10 RACKETS KIT JR T600 21"



Set of 10 rackets JR T600 21" + 1 rackets bag ref 011084.

Reference: 012059

Kit

10 RACKETS KIT JR T700 23"



Set of 10 rackets JR T700 23" + 1 rackets bag ref 011084.

Reference: 012060

Kit

10 RACKETS KIT JR T800 25"



Set of 10 rackets JR T800 25" + 1 rackets bag ref 011084.

Reference: 012061

Kit

BAG FOR TENNIS RACKETS



Opening in «U»

LENGTH	WIDTH	HEIGHT
80 cm	48 cm	33 cm

Nylon canvas bag reinforced 600 deniers. It is composed of a large main compartment with an opening in U to easily store until 20 tennis rackets. Side pocket with an opening in U to store the tubes for tennis balls (until 6 tubes). Handles and transport adjustable and reinforced shoulder strap. Colour: black. Delivered without racket and ball.

Reference: 011084

Unit

SET OF 2 TARGETS FOR TENNIS NET

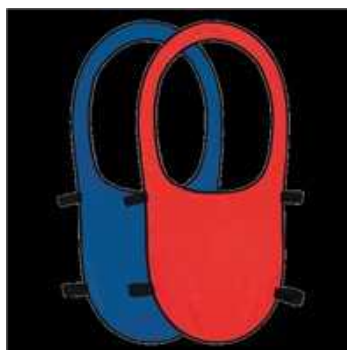

WIDTH	HEIGHT
53 cm	122 cm

Nylon targets to fix to the net per hook and loop. For a precision work. Colour: 1 red target and 1 blue.

Reference: 012049

Set of 2

COACH CLIPBOARD TENNIS/PADDLE



WIDTH	HEIGHT
22.5 cm	36 cm

Rigid wipe-clean PVC board with metal clip. One side features a Tennis court, the other a Paddle court. Supplied with a marker.

Reference: 063191

Sports bags, storage and transport
 Multisports
 Training and ground accessories
 Coach, referee and player
 First-aid
 Fitness, bodybuilding and gym
 Swimming
 Combat sports
 Racket sports
 Athletics
 Balls
 School
 Nets and accessories

• TROLLEY FOR TENNIS BALLS



Bag	
w.	34 cm
L.	33 cm

Capacity: +/- 90 Balls

Practical to use



Trolley	
H.	110 cm
w.	40 cm
L.	45 cm



Foldable trolley with wheels. Metal structure and nylon bag 420 deniers. Supplied without ball. Transport bag included.

Reference: 012048

Unit

ELASTIC CORD

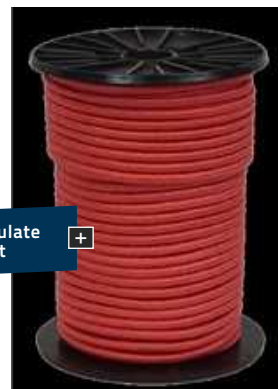

Can simulate a net

RECYCLABLE
DIAMETER
5 mm

This rubber cord has an elastic multi-threads covered with red textile. Perfect for the introduction to high jump.

Reference: 022008	25 m
Reference: 022102	50 m

MINI-TENNIS KIT



Available in 2 dimensions: 4 m and 6 m

Net tension system by hook and loop



Easily adjustable heights: 0.90 m and 1.10 m by clips system

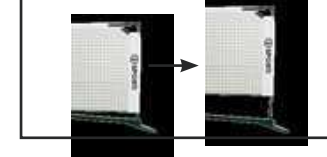

Quick assembly and disassembly

RECYCLED
RECYCLABLE



Set for both ball-tennis and mini-tennis. Steel rectangular structure very stable due to its wide feet which avoid any risk of toppling as well as a back and forth tip over. Designed to use it on hard floor, grass and synthetic pitch. Very practical and easy to set up, this set will be mounted and dismantled very quickly. Delivered with a net PE 2 mm, mesh 40 mm. Delivered with carry bag. Available in 2 lengths: 4 m and 6 m. 2 easily adjustable heights: 0.90 m and 1.10 m.

Reference: 099046	4 m	Reference: 099047	6 m
Reference: 099046F	4 m net	Reference: 099047F	6 m net

Reference: 0990475

The transport bag only (compatible with 4 and 6m)

TENNIS MATCH POINTER SCOREBOARD



DIGITS HEIGHT	WIDTH	HEIGHT
7 cm	46 cm	60 cm

Match pointer for tennis matches. Double-sided display with easy set up. Easy to use, just turn the discs to change the score.

Reference: 012011 Unit

FOLDABLE MINI-TENNIS KIT

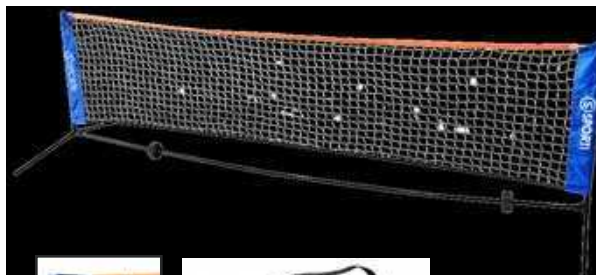

Practical & easy to install

RECYCLED
RECYCLABLE

LENGTH	HEIGHT
3 m	0.80 m

Very stable thanks to its large base and its structure in steel tube of 19 mm diameter. Very practical and easy to install, this set will be assembled and dismantled in only 2 minutes. Delivered with 2 mm PE net and carrying bag.

Reference: 099048 Unit

Athletics

Throwing introduction	146
Throwing and magnaesia	147
Running: starting-blocks, hurdles and relays	148
Muscle-strengthening and speed ladders	149
Measuring devices, elastic jump cord and podium	150

TO DISCOVER

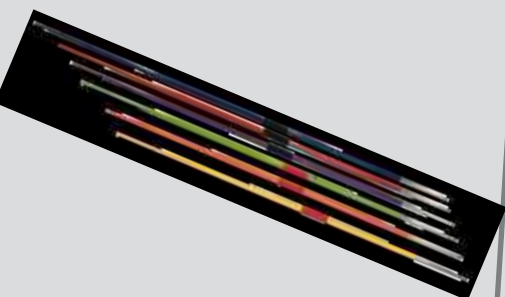

P.147



P.150



P.150

THROWING INTRODUCTION

• VORTEX JAVELIN

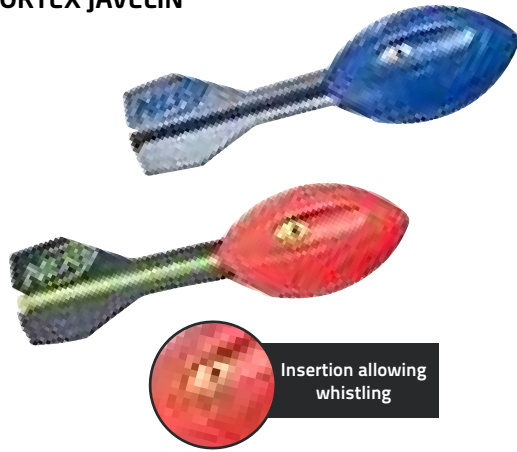

Insertion allowing whistling

WEIGHT
125 g

LENGTH
33 cm

Especially designed for the introduction to throwing, the vortex is fun thanks to the whistlings during its flight and securing with its foam material. Matching colour.

Reference: 099051 Unit

• MINI VORTEX



WEIGHT
40 g

LENGTH
17 cm

It allows to discover the pleasures of throwing. Very appreciated by children due to its manoeuvrability.

Reference: 099215U

FOAM JAVELIN

SPORTi



WEIGHT
110 g

LENGTH
90 cm

Foam javelin of high density, slightly weighted on the front.

Reference: 099050

MULTI-THROW DISCUS

SPORTi



RECYCLABLE

Rubber discus with a good catch in hand and an arrow indicating the direction of rotation.

Reference: 099333A	400 gr.	Ø: 20 cm	Red
Reference: 099333B	600 gr.	Ø: 20 cm	Yellow
Reference: 099333C	800 gr.	Ø: 20 cm	Blue

SOFT INITIATION DISCUS

SPORTi



RECYCLABLE

DIAMETER
16 cm

It allows to discover the pleasures of throw. Very appreciated by children due to its manoeuvrability.

Reference: 099309	red / Ø: 16cm / 200 gr.
Reference: 099332	blue / Ø: 16cm / 350 gr.

SOFT WEIGHTED BALL

sea



RECYCLED

RECYCLABLE

Ref: 021046	0.2 kg. Orange	Ø: 6.5cm
Ref: 021045	0.5 kg. Beige	Ø: 9.5cm
Ref: 021047	1 kg. Red	Ø: 10cm
Ref: 021048	2 kg. Green	Ø: 13cm
Ref: 021049	3 kg. Blue	Ø: 14cm

SOFT INITIATION WEIGHT

SPORTi



RECYCLABLE

WEIGHT
600 g

DIAMETER
9 cm

Perfect for learning of throw. Colour: Blue.

Reference: 099301 Unit

SOFT INITIATION HAMMER

SPORTi



RECYCLABLE

WEIGHT
350 g

DIAMETER
14 cm

Hammer in flexible PVC designed especially for a safe introduction to the hammer. It can be used both indoor and outdoor.

Reference: 025003 Unit

TRAINING WEIGHT



Painted cast iron weight to quickly identify the levels.

Reference: 021026	2 kg.	Dark blue	Ø: 8 cm
Reference: 021027	3 kg.	Green	Ø: 9.4 cm
Reference: 021028	4 kg.	Black	Ø: 10 cm
Reference: 021029	5 kg.	Yellow	Ø: 11 cm
Reference: 021030	6 kg.	Red	Ø: 11.8 cm
Reference: 021031	7.26 kg.	Black	Ø: 12.4 cm

THROW DISCUS

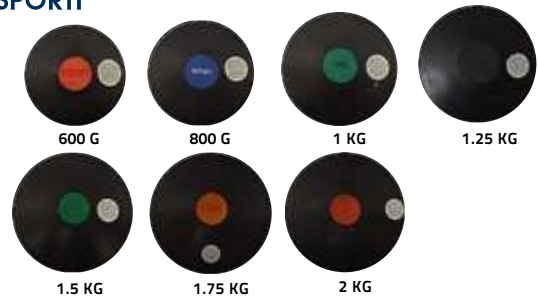

Rubber discus with coloured insert allowing to quickly recognise them.

Reference: 021037	600gr.	Ø: 16.5 cm	Red
Reference: 021038	800gr.	Ø: 16.5 cm	Royal
Reference: 021035	1kg.	Ø: 18 cm	Green
Reference: 021032	1.25kg.	Ø: 18 cm	Black
Reference: 021033	1.5kg.	Ø: 20 cm	Green
Reference: 021034	1.75kg.	Ø: 21.5 cm	Brown
Reference: 021036	2kg.	Ø: 22 cm	Red

TRAINING JAVELIN



Javelin made in aluminium alloy with chrome steel point. Rope handle and a metallic paint finish.

Reference: 021039	300 g	L: 172 cm	22 mm Ø	Yellow (red rope)
Reference: 021040	400 g	L: 186 cm	22 mm Ø	Orange (red rope)
Reference: 021041	500 g	L: 205 cm	22 mm Ø	Green (red rope)
Reference: 021042	600 g	L: 221 cm	24 mm Ø	Purple (black rope)
Reference: 021043	700 g	L: 239 cm	28 mm Ø	Red (black rope)
Reference: 021044	800 g	L: 261 cm	28 mm Ø	Blue (black rope)

Javelins bag - 16.5 cm diameter / L.276 cm

SET OF 12 ROUND FIELD MARKERS



Short throws

Numbered from 1 to 12



Round model.

Reference: 024007 Set of 12

SET OF 12 RECTANGULAR FIELD MARKERS



Long throws

Numbered from 1 to 12

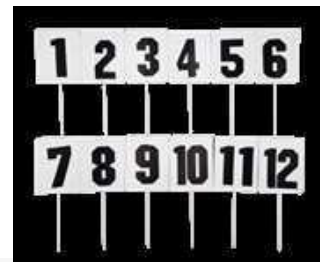

Rectangular steel model. High rounded surface to facilitate anchoring to the ground.

Reference: 024008 Set of 12

BLOCK OF MAGNESIA



Box of 8 blocks of 56 gr of magnesia.

- 1 Training: Flexible and soft grain for all sports needing a firm and sure taking in hand.
- 2 Competition: Especially created for athletes who need a very strong grip due to long and difficult movements.

Reference: 033127 1 Training magnesia
Reference: 033128 2 Competition magnesia

LIQUID MAGNESIA



VOLUME 200 ml

200 ml flask, created with particular drying agents ensuring a strong grip in a few seconds and an absorption of all excessive perspiration.

Reference: 033130 Unit

TRAINING STARTING BLOCK



LENGTH
61 cm

Suitable for right and left-footed users. Adjustable spacing. Non-slip coating. 14 positions with 3.5 cm spacing. 7cm wide steel rack. Supplied with spikes for fixing to the floor and a spike system on the side of the blocks for even greater stability.

Reference: 025006 Unit

STARTING BLOCK CLUB



LENGTH
81 cm

Suitable for right-footed and left-footed people. Adjustable spacing. Non-slip coating. 20 positions with 2cm spacing. 7.5cm wide steel rack. Supplied with ground fixing spikes.

Reference: 025007 Unit

SET OF 6 RELAY BATONS



LENGTH
30 cm

DIAMETER
38 cm

Set of 6 PVC relay batons.

Reference: 025004 Unit

TRAINING HURLDE 4 HEIGHTS

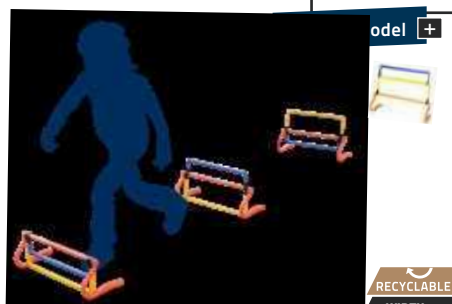

RECYCLABLE
WIDTH
47 cm

4 positions for 4 different heights

Perfect to prepare diversified motor ability sessions, these training hurdles adjustable on 4 heights (15 cm, 23 cm, 29 cm and 36.5 cm) allow to offer different exercises according to age and the desired level of difficulty. Easily transportable and foldable. Designed for both indoor and outdoor use.

Reference: 025032 Unit

INITIATION HURDLE

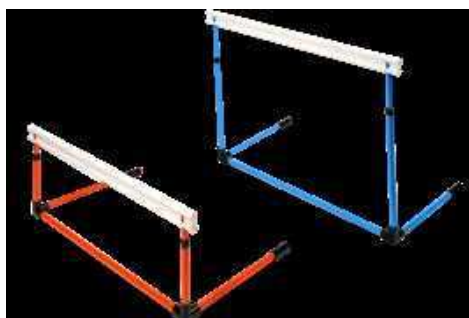

WIDTH
100 cm

Hurdle in PVC tube with an adjustment system of the height.

Reference: 063386	Red	Adjustable from 35 to 60 cm
Reference: 063393	Blue	Adjustable from 60 to 105 cm

SPEED HURDLE



Available in kit
6 hurdles / 3 heights

* Available in kit: 2 x 20 cm + 2 x 40 cm + 2 x 60 cm

Speed hurdles in elastomeric material, very flexible, light and easily transportable.

Reference: 025013B	Ø: 16 mm - L.60 cm - H.20 cm
Reference: 025013C	Ø: 16 mm - L.60 cm - H.40 cm
Reference: 025013D	Ø: 16mm - L.60 cm - H.60 cm
Reference: 025013A	KIT: 2 x 20 cm + 2 x 40 cm + 2 x 60 cm

FLEXIBLE HURDLE

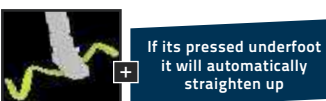

If its pressed underfoot it will automatically straighten up

RECYCLABLE

Flexible PVC hurdle to avoid any danger. It automatically gets its original position back if someone steps on.

Reference: 063184	w. 46 cm. H. 15 cm	Turquoise
Reference: 063185	w. 46 cm. H. 23 cm.	Yellow
Reference: 063186	w. 46 cm. H. 30 cm.	Orange

SPEED HURDLE



RECYCLABLE

Hurdle in reinforced PVC. Practical and easy to transport and store.

Reference: 063183A	Width. 47 cm. Hei. 15 cm.	Turquoise
Reference: 063183B	Width. 47 cm. Hei. 30 cm.	Yellow
Reference: 063183C	Width. 47 cm. Hei. 45 cm.	Orange

BOUNCE-BACK HURDLE

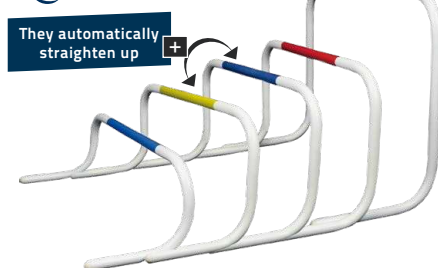

They automatically straighten up

Very useful, these hurdles automatically straighten up. Width: 70 cm.

Reference: 063302A	w. 70 cm. H. 21 cm.	White/Blue
Reference: 063302B	w. 70 cm. H. 26 cm.	White/Yellow
Reference: 063302C	w. 70 cm. H.31 cm.	White/Blue
Reference: 063302D	w. 70 cm. H. 36 cm.	White/Red
Reference: 063302E	w. 70 cm. H. 50 cm.	White/Blue

TRAINING HARNESS

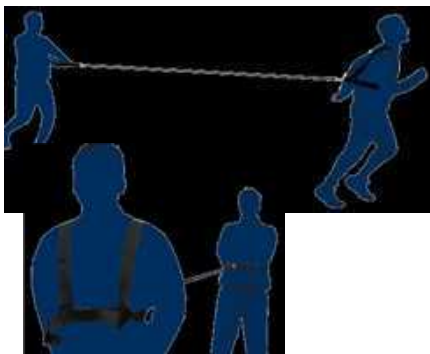

This training harness is perfect to work the muscle-strengthening. Widely used in sports that require accelerations and sprints of short distances. It has a foam handle very ergonomic for the person who exerts a force against the sportsman movement, a harness very comfortable held to the shoulder level to avoid any risk of injury.

Reference: 062735 Unit

WEIGHTED VESTS



10 KG



+ Delivered with removable ballasts

It allows an effective work of the muscle-strengthening by adding to the sportsperson an overloading. Adjustable belt by hook and loop fastener (for the 10 kg) or by clips (for the 5 kg).

Reference: 062767

5 kg vest

w. 36 cm.

H. 36 cm.



Reference: 062736

10 kg vest

w. 44 cm.

H. 55 cm.

POWER SPEED

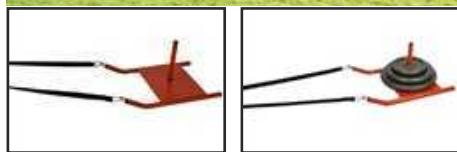

Tray
w. 37 cm
L. 55 cm



Recommended for resistance exercises in order to develop explosivity and running speed. Adjustable belt. Initial weight: 3.5 kg. Possibility to add some weights until 60 kg.

Reference: 060063 Unit

• CAST-IRON WEIGHT DISC



Adapted to strength training bars of Ø28 mm.

Reference: 062758

5 kg.

Reference: 062759

10 kg.

Reference: 062760

20 kg.

SET OF 10 TRAINING SLATS



LENGTH 50 cm
WIDTH 4 cm
HEIGHT 0.5 cm

Set of 10 slats in white PVC.

Reference: 025008 Set of 10

PARACHUTE



Training parachute in durable nylon with belt. It allows to work his speed and power.

Reference: 060077 Unit

SPEED LADDER 2 M

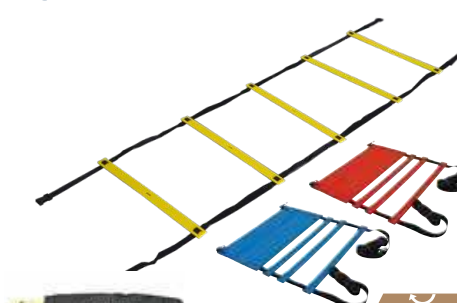

LENGTH 2 m
WIDTH 50 cm



Made with 2 nylon straps and 5 flat bars for safety reasons, it is the perfect tool to work the coordination. Supplied with a carrying bag.

Reference: 063180A Unit - Yellow

Reference: 063180A Unit - Blue

Reference: 063180A Unit - Red

SPEED LADDER 4 M

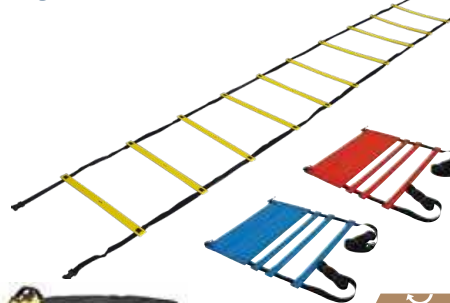

LENGTH 4 m
WIDTH 50 cm



Made with 2 nylon straps and 10 flat bars for safety reasons, it is the perfect tool to work the coordination. Supplied with a carrying bag.

Reference: 063177A Unit - Yellow

Reference: 063177A Unit - Blue

Reference: 063177A Unit - Red

DOUBLE SPEED LADDER

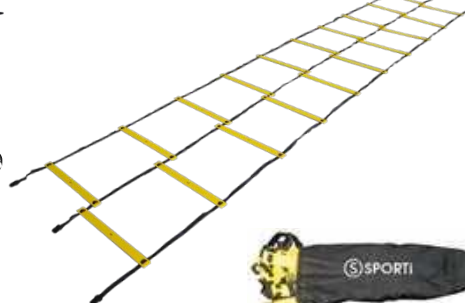

LENGTH 4 m
WIDTH 1 m



Same composition as the simple speed ladder, the double speed ladder allows to work in a different way in particular thanks to a more important distance between the bars. Supplied with a carrying bag.

Reference: 063178 Unit

RED ELASTIC HIGH JUMP CORD



RECYCLABLE
DIAMETER
5 mm

This rubber tape has an elastic multi-threads covered with red textile. Perfect for the introduction to high jump.

Reference: 022008 25 m
Reference: 022102 50 m

ELASTIC BAND



WIDTH
50 mm

Elastic band with a hook and loop fastener hanging system at both ends. Fixed between two posts, it can be used as a net for ball games, in athletics for high jump, in Fitness for muscle-strengthening, in football or handball to delimit targets between goal posts and other applications. It is not sensitive to humidity and can be used both inside and outside.

Reference: 022103 L. 3 m (stretching up 6 m) Neon Orange / Neon Yellow
Reference: 022104 L. 6 m (stretching up 12 m) Neon Orange / Neon Yellow

TAPE MEASURE



10 M



20 M



30 M



50 M



100 M

RECYCLABLE

Thermoplastic box with tape measure in fibreglass with centimeter and inch graduation.

Reference: 062737 10 m
Reference: 062745 20 m
Reference: 024051 30 m
Reference: 024052 50 m
Reference: 024053 100 m

PULSE METER



RECYCLABLE

Chromed metal box, 4 numbers of 47 x 25 mm, with reset function.

Reference: 024055 Unit

BUILT-IN SIREN AND MICROPHONE



RECYCLABLE

WEIGHT 1.2 kg
DIAMETER 20.5 cm
LENGTH 34 cm

All ABS body, sturdy yet light weight. Clear sound, long range (500 m). Conveniently located volume control and switch. Power output: 30 W. Power source: 6 x 1.5V R14 (not included) for an easy using. Weight (without cell): 1.2 kg.

Reference: 024048 Unit

ODOMETER



Wheel
Ø 31.8 cm

Unfolded
L. 102 cm

Folded
L. 55 cm

RECYCLABLE

WEIGHT
2 kg

+ Retractable

Foldable to facilitate the storage. Delivered with a carry bag. Features: measuring range from 0 to 99 999.9 m, resolution 0.1 m.

Reference: 024078 Unit

INTEGRATED 3 PLACES MULTISPORTS PODIUM



+ Reinforced structure

Integrated to facilitate storage



Podium n°3
ref 025001

OVERALL WEIGHT 25 kg
BOX N°2 & 3 60 x 48 x 26 cm
BOX N°1 66 x 63 x 48 cm

Wooden white podium with white painted iron structure. Black anti-skid rubber surface on the top. Podium n°2 and n°3 could be easily stored in the podium n°1 to be easily transportable and stored. Tip: store your podium inside and avoid moisture.

Reference: 025002 Unit
Reference: 025001 Podium n°3

Balls

Football, futsal, beach soccer	152
Basketball	154
Handball	155
Volleyball and water-polo	156
Rugby and American football	157
Foam balls	158
Foam balls and «elephant skin» balls	159
Educational balls	160
Giant balls and space hopper	162

TO DISCOVER



P.155

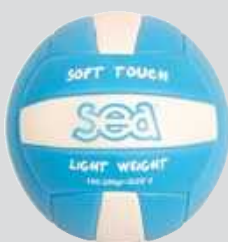

P.158



P.163

UNITED FOOTBALL



SIZE 3



SIZE 4



SIZE 5

Ball designed for training, very good price-quality ratio for this ball made with synthetic materials very flexible and resistant with its 4 layers. Available in 3 sizes: Size 3 (White / Blue), Size 4 (White / neon yellow) and Size 5 (White / Red).

- Reference: 067319A
- Reference: 067319B
- Reference: 067319C

- Size 3 - Unit
- Size 4 - Unit
- Size 5 - Unit

BEACH SOCCER BALL



WEIGHT 380 g
DIAMETER 20 cm

Specially adapted for sand game to resist abrasion while remaining flexible.

Reference: 067320 Size 5

FUTSAL BALL



CIRCUMFERENCE 62/64cm
WEIGHT 400/440 g
DIAMETER 20 cm

Training futsal ball, hand-stitched and shiny, designed for an intensive use on all types of floor. Synthetic materials very flexible and resistant. It rebounds 3 times when it is thrown at a height of 1 m. Official circumference 62/64 cm.

Reference: 067291 Unit

INDOOR FOOTBALL



SIZE 4



SIZE 5

Traditional indoor football, 32 pannels hand-stitched. Felt coating, latex bladder. It can be used on all types of indoor floor (except abrasive like tarmac). Its composition allows to have a classic rebound.

Reference: 067289A Size 4
Reference: 067289B Size 5

RUBBER FOOTBALL



SIZE 3



SIZE 4



SIZE 5

Grained rubber ball on ultra resistant nylon carcass. For all types of surfaces, including the most abrasive ones like tarmac in a schoolyard. 3 available sizes: Size 3 (Colour Yellow / White), Size 4 (Colour Blue / White) and Size 5 (Colour Red / White).

- Reference: 067040A
- Reference: 067040B
- Reference: 067040C

- Size 3 - Unit
- Size 4 - Unit
- Size 5 - Unit



SMALL BELLS BALL



RECYCLABLE	
WEIGHT	DIAMETER
540 g	20 cm

Openwork PVC Goalball with 2 bells inside. Adapted for group games based on hearing. It allows to develop sense of hearing.

Reference: 099008 Unit

CECIFOOT BALL AND TORBALL



SIZE 3		SIZE 5	
WEIGHT	DIAMETER	WEIGHT	DIAMETER
450 g	19 cm	510 g	22 cm

Official Torball with low rebound and with bells inside allowing a person who is partially sighted or blind to locate it when it is rolling. Practice place: inside and outside. Material: polyurethane. Official size and weight. Available in 2 sizes.

Reference: 067016A Size 3
Reference: 067016B Size 5

SET OF 6 EYE MASK



Double elastics +

WIDTH	LENGTH
8 cm	18 cm

Nylon blindfolds with an elastic cord. Each set is composed of 6 assorted colours. Designed for various group activities in communities. Dimensions: 18 cm x 8 cm.

Reference: 099140 Set of 6

SET OF 10 BLIND MASKS



Double elastics +

WIDTH	LENGTH
8 cm	18 cm

Nylon masks with double elastic bands. Designed for use in a variety of community activities. Set of 10 back blind mask. Available colours : black and red.

Reference: 099136 Set of 10 black blind masks
Reference: 099138 Set of 10 red blind masks



INITIATION FOOTBALL



RECYCLABLE	
WEIGHT	DIAMETER
315 g	21 cm

Beginner football in flexible plastic which allows a long lifespan and flexibility. It can be used on all types of floor, including very hard (for example tarmac). Colour: Turquoise/Blue.

Reference: 067037 Unit

EDUCATIONAL FOOTBALL



RECYCLABLE	
WEIGHT	DIAMETER
300 g	21.5 cm

In moulded PVC (polymer resin and plasticizer) for a long lifespan and flexibility rubber valve. Antimicrobial surface treatment. It can be used on all types of floor, including very hard (for example tarmac). Available in 3 colours: Red, Yellow and Green.

Reference: 067038 Unit

Sports bags, storage and transport
Multisports
Tracing and ground accessories
Coach, referee and player
First-aid
Fitness, bodybuilding and gym
Swimming
Combat sports
Racket sports
Athletics
Balls
School
Nets and accessories

BASKETBALL

3X3 BASKETBALL



WEIGHT
600 g

CIRCUMFERENCE
72 to 74 cm



Basketball especially designed for 3-on-3 play. Size 6 ball with the weight of a size 7.

Reference: 067328 Unit

CELLULAR TRAINING BASKETBALL



SIZE 5



SIZE 6



SIZE 7



Basketball designed for introduction. Its rubber cellular structure allows a very good grip and an important resistance to abrasion. For all types of surfaces, even outdoor. 3 available sizes.

Reference: 067300A Size 5
Reference: 067300B Size 6
Reference: 067300C Size 7

RUBBER BASKETBALL



SIZE 3



SIZE 5



SIZE 6



SIZE 7



Rubber basketball ball 8 panels. Nylon carcass ultra resistant. For all types of surfaces, even outdoors. Available in 4 sizes.

Reference: 067282A Size 3 Circumference 55 to 60 cm.
Reference: 067282B Size 5 Circumference 69 to 71 cm.
Reference: 067282C Size 6 Circumference 72 to 74 cm.
Reference: 067282D Size 7 Circumference 75 to 78 cm.

DISCOVERY BASKETBALL



WEIGHT
220 g

CIRCUMFERENCE
62 cm

DIAMETER
20 cm



Discovery basketball, with a classic rebound and an easy catch in hand (it doesn't hurt in case of shock). Ball with a moulded flexible plastic coating. It is suitable for a use inside or outside.

Reference: 067110 Unit

FUTURE CHAMP



WEIGHT
350 g

DIAMETER
20 cm



Ball with a moulded flexible plastic coating, a classic rebound and an easy catch in hand (it doesn't hurt in case of shock). Perfect for mini-basket. It is suitable for a use inside or outside.

Reference: 067111 Unit

SCHOOL COMPOSITE BALL



Micro-bubbled synthetic ball, granular surface very flexible. Reinforced nylon carcass allowing a long-term good performance to inflation. This school composite ball was designed with teachers taking the best of similar models existing with the quality guarantee SEA. Ball highly flexible. For an outside use on all types of floor including very hard (tarmac, etc.).

Reference: 067232A	00	Red
Reference: 067232B	0	Green
Reference: 067232C	1	Blue
Reference: 067232D	2	Yellow

PROGRESSIVE HANDBALL



Handball with a moulded PVC coating (polymer resin and plasticizer), covered with a polyurethane foam skin. Double-wall carcass allowing an increased resistance. Rebound of an excellent quality equivalent to plastic but with the softness of the foam. Antimicrobial surface treatment.

Reference: 067310A	00	190 g
Reference: 067310B	0	220 g
Reference: 067310C	1	290 g
Reference: 067310D	2	360 g

BEGINNER HANDBALL



S0

RECYCLABLE

WEIGHT 155 g

DIAMETER 15 cm

Beginner handball in moulded flexible plastic, light, for a smooth discovery of handball. Size 0.

Reference: 067085 Unit

1ST STEPS HANDBALL



S0

S0

RECYCLABLE

WEIGHT 155 g

DIAMETER 15 cm

For the discovery and introduction of the minihand thanks to a synthetic material very flexible. Available in neon orange and neon green. Size 0.

Reference: 067083 Unit

BEACH HAND BALL



S2 (WOMAN)

S3 (MAN)



Moulded PVC cover (polymer resin and plasticizer) covered with a polyurethane foam skin. Double-walled frame, suitable for practice on sand.

Reference: 067327A	S2 - 290 g	Unit
Reference: 067327B	S3 - 330 g	Unit

EDUCATIONAL HANDBALL



RECYCLABLE

WEIGHT 190 g

DIAMETER 15 cm

Material: moulded PVC coating (polymer resin and plasticizer) flexible and resistant. Construction: rubber valve. Antimicrobial surface treatment. Available in 3 colours: blue, yellow and green.

Reference: 087090 S0 - Unit

TRAINING VOLLEYBALL



WEIGHT
260 g

DIAMETER
21 cm

18-panel PVC volleyball for club and school training. Size 5.

Reference: 067132

Unit

SOFT VOLLEYBALL

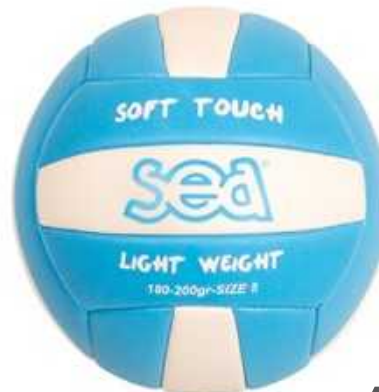

WEIGHT
190 g

DIAMETER
20 cm

Lighter (between 180 and 200 g) with a soft and flexible feel, this ball is ideal for beginner use in clubs, especially for baby volleyball. White/Blue colour.

Reference: 067129

Unit

BEACH VOLLEYBALL



WEIGHT
280 g

DIAMETER
21 cm

Beach volleyball in polyurethane micro ventilated insuring a great flexibility and a very nice soft touch.

Reference: 067292

Unit

BEGINNER VOLLEYBALL



WEIGHT
210 g

DIAMETER
20 cm

Volleyball made with flexible plastic of high quality (thick). Block ball without inside bladder. Long-term good performance to inflation. This ball can be multipurpose and used for other games than volleyball.

Reference: 067131

Unit

EDUCATIONAL VOLLEYBALL



WEIGHT
220 g

DIAMETER
20 cm

Ball in moulded PVC (polymer resin and plasticizer). Block ball without inside bladder. Long-term good performance to inflation, rubber valve. This ball can be multipurpose and used for other games than volleyball. Antimicrobial surface treatment. Available in 3 different colours.

Reference: 067130

Unit

WATER POLO BALL



WEIGHT
450 g

DIAMETER
21 cm

Rubber water polo ball. Ideal for initiation, training and schools. Size 5.

Reference: 041049

Unit

RUGBY BALL



SIZE 3



SIZE 4



SIZE 5



With pimples for a better grip

RECYCLABLE

Ball designed for introduction to rugby practice. Excellent grip for a very good catch in hand. Hand-stitched.

Reference: 067314A

Size 3 • White/Blue

Reference: 067314B

Size 4 • White/Yellow

Reference: 067314C

Size 5 • White/Red

SOFT RUGBY BALL



Water-resistant

The sponge rugby ball is incomparable with standard products. Perfect for the discovery of indoor rugby thanks to its low rebound and its very soft and flexible touch. It is composed of soft polypropylene/cotton inner foam and vinyl surface. Water-resistant.

Reference: 067230

Size 2

Unit

L.21 cm - 12.5 cm Ø - 200 g

Reference: 067231

Size 3

Unit

L.27 cm - 15 cm Ø - 320 g

AMERICAN FOOTBALL



EDUCATIONAL RUGBY BALL



WEIGHT 385 g
DIAMETER 12.5 cm
LENGTH 27 cm

RECYCLABLE

WEIGHT 300 g
DIAMETER 15 cm
LENGTH 26 cm

RECYCLABLE

American football with a flexible plastic coating and heavy-duty for introduction, legal size.

Reference: 067062

Unit

Junior ball in moulded PVC (polymer resin and plasticizer) flexible and heavy-duty. Antimicrobial surface treatment. Available in 3 colours.

Reference: 067061

Unit

FOAM BALLS

TWO-COLOURED FOAM BALLS



Foam ball in raw polyurethane. These very light balls are used for any type of indoor game. Low rebound.

Reference: 099310	120 mm. Ø	Unit	60 g
Reference: 099172	120 mm. Ø	Set of 4	60 g
Reference: 099335	175 mm. Ø	Unit	140 g
Reference: 099171	175 mm. Ø	Set of 4	140 g
Reference: 099336	200 mm. Ø	Unit	180 g
Reference: 099173	200 mm. Ø	Set of 4	180 g

DYNAMIC PLAIN FOAM BALL

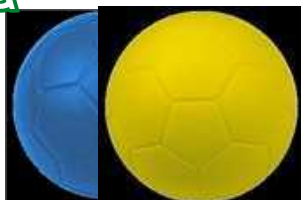

15CM



19 CM

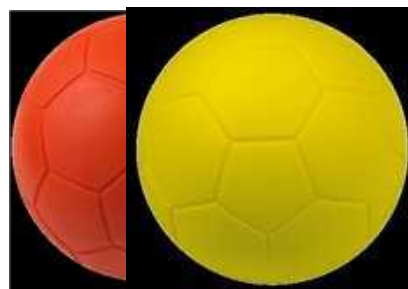

21 CM

Foam ball in high density polyurethane.

Reference: 067233	15cm. Ø	Weight: 160 g	Blue / Yellow
Reference: 067208	19cm. Ø	Weight: 250 g	Red / Green
Reference: 067215	21cm. Ø	Weight: 300 g	Yellow / Red



FOAM FOOTBALL



WEIGHT 210 g
DIAMETER 22 cm

DYNAMIC FOAM FOOTBALL



WEIGHT 320 g
DIAMETER 21 cm

Foam ball in raw polyurethane.

Reference: 067305 Unit

Foam football in high density polyurethane.

Reference: 067210 Unit

DISCOVERY AND DYNAMIC FOAM BALL PACK



KIT

This pack includes 3 foam balls: a plain ball of 16 cm, a foam football and a foam rugby ball. In high density polyurethane.

Reference: 067236 Unit



HIGH DENSITY FOAM BALLS



A



B



C

Balls in high density polyurethane. These balls of high quality can be used both indoor and outdoor. They rebound more than traditional foam balls.

Reference: 067082	Handball A	15 cm.	190 g
Reference: 099020	Basketball B	20 cm.	275 g
Reference: 099321	Football C	20 cm.	285 g

HIGH DENSITY FOAM RUGBY BALL



WEIGHT	DIAMETER	LENGTH
165 g	15 cm	24 cm

Rugby ball in raw polyurethane foam, this very light ball is used for any type of indoor game because it has a low rebound. Perfect for the discovery of indoor rugby.

Reference: 067304 Unit

DYNAMIC FOAM RUGBY BALL



WEIGHT	DIAMETER	LENGTH
255 g	13 cm	25 cm

Rugby ball in high density polyurethane foam. It is unrivalled with standard products: abrasion resistance, soft touch and flexible. Especially designed for an intensive use.

Reference: 067293 Unit

HIGH DENSITY FOAM VOLLEYBALL



WEIGHT	DIAMETER
300 g	21 cm

Foam volleyball in high density polyurethane. It can be used both indoor and outdoor. They rebound more than traditional foam balls.

Reference: 067128 Unit

FOAM BALL 7 CM



WEIGHT	DIAMETER
15 g	7 cm

Foam balls in raw polyurethane for all the racket games. Available in 3 different colours: yellow, red and blue.

Reference: 099241 Unit
Reference: 099370 Set of 24

FOAM BALL 9 CM



WEIGHT	DIAMETER
30 g	9 cm

Foam balls in raw polyurethane for all the racket games. Available in 3 different colours: yellow, red and blue.

Reference: 099242 Unit
Reference: 099371 Set of 20

«ELEPHANT SKIN» BALL



Puncture-proof+



In polyurethane retractable foam, they are covered with an elastomere skin. This «puncture-proof» ball becomes distorted and reformed in a few seconds for multiple uses. Very flexible, resistant and washable.

Reference: 099337	7cm. Ø	Blue / Green
Reference: 099338	16cm. Ø	Yellow / Red
Reference: 099339	18cm. Ø	Red / Green
Reference: 099340	21cm. Ø	Blue / Yellow

Sports bags, storage and transport

Multisports

Tracing and ground accessories

Coach, referee and player

First-aid

Fitness, bodybuilding and gym

Swimming

Combat sports

Racket sports

Athletics

Balls

School

Nets and accessories

Find all our masks on page 153

SET OF 5 12 CM INTRODUCTION BALLS



RECYCLED RECYCLABLE

WEIGHT	DIAMETER
70 g	12 cm

Smooth ball in PVC. Delivered in set of 5 balls. Colours: green, pink, blue, red and yellow.

Reference: 067326A

Set of 5

SET OF 5 18 CM INTRODUCTION BALLS



RECYCLED RECYCLABLE

WEIGHT	DIAMETER
100 g	18 cm

Smooth ball in PVC. Delivered in set of 5 balls. Colours: green, pink, blue, red, orange and yellow.

Reference: 067322A

Set of 5

MULTISPORTS BALL



RECYCLED RECYCLABLE

WEIGHT	DIAMETER
275 g	21 cm

Rubber ball with a smooth surface, very robust, can be used for all kinds of sports activities and on any surface.

Reference: 067086

Unit

MULTIBALL RUBBER BALL



13 CM



18 CM



22 CM



Multipurpose rubber ball, for all uses. Striated surface for a better catch in hand. Very resistant for both inside and outside use.

Reference: 067307A	13cm.	110 g
Reference: 067307B	18cm.	260 g
Reference: 067307C	22cm.	415 g

SET OF 4 10 CM HONEYCOMBED BALLS



+ Rebound



RECYCLED RECYCLABLE

WEIGHT	DIAMETER
60 g	10 cm

Honeycombed PVC ball for a better catch in hand. Delivered in set of 4 colours : blue, yellow, red and green. Diameter: 10 cm. Weight: 60 g.

Reference: 099009

Set of 4

LOT DE 4 BALLE SENSORIELLES



+ Rebound

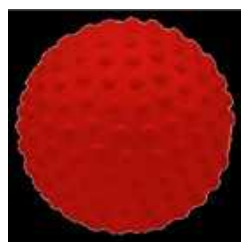

Touch ball offers an easy and secure grip thanks to its spikes. Both light and strong ball. Material: PVC. Delivered in set of 4 colours: blue, yellow, red and green.

Reference: 099010

10 cm Ø - 80 g. - Set of 4

Sports bags, storage and transport
Multisports
Tracing and ground accessories
Coach, referee and player
First aid
Fitness, bodybuilding and gym
Swimming
Combat sports
Racket sports
Athletics
Balls
School
Nets and accessories

SET OF 6 EMOTIONS BALLS



RECYCLABLE
DIAMETER
20 cm

Set of 6 PVC balls 20 cm diameter (6 colours/6 emotions).

Reference: 099013L Set

HONEYCOMB BALL



These balls moulded in one piece are very resistant and pleasant to the touch. They are easy to control, to catch or to throw. Matching colours.

Reference: 099220A 12 cm Ø 180 g
Reference: 099220B 18 cm Ø 450 g

SET OF 20 BALLOONS



2026
NEW

DIAMETER
15 cm

Set of 20 balloons, 15cm diameter. Assorted colours (yellow, red, green and blue). Biodegradable balloons, made in France.

Reference: 099012 Set

ULTRA-LIGHT BALLS



RED YELLOW



RECYCLED
RECYCLABLE
WEIGHT
180 g
DIAMETER
25 cm

Flexible and very light PVC ball, inflatable with the mouth with a straw. Available in 3 colours: Blue, Yellow and Red.

Reference: 099157 Unit

BOUNCING BALL



DIAMETER
7.2 cm

Material: plain rubber. Matching colours.

Reference: 099001U Unit

MULTIFORM BALL



Ball with 6 rubber sides. Very bouncing and unpredictable. It makes gestural learning easier. Matching colours.

Reference: 099240 Unit

HEDGEHOG MASSAGE BALL



RECYCLED
RECYCLABLE

Pimples balls are designed for soft massages and stimulation of the reflex zones. They boost blood circulation.

Reference: 099341 6 cm Ø 40 g
Reference: 099342 7 cm Ø 50 g
Reference: 099343 8 cm Ø 70 g
Reference: 099344 9 cm Ø 90 g
Reference: 099379 10 cm Ø 150 g

Sports bags, storage and transport

Multisports

Tracing and ground accessories

Coach, referee and player

First-aid

Fitness, bodybuilding and gym

Swimming

Combat sports

Racket sports

Athletics

Balls

School

Nets and accessories

GIANT BALLS AND SPACE HOPPER

GIANT BALL

75 cm delivered with 2 bladders



RECYCLABLE

Giant ball with a low rebound. Adapted for motor skills of children, it allows the improvement of the eye-hand coordination. Ultra-light. Nylon fabric with latex bladder.

Reference: 099271	The ball with 2 bladders	75 cm. Ø
Reference: 099274	The ball with 1 bladder	120 cm. Ø
Reference: 099272	The bladder	75 cm. Ø
Reference: 099273	The bladder	120 cm. Ø

SPACE HOPPER



A



B

RECYCLABLE

Flexible and thick plastic material. Ergonomic handle and cork. Inflatable space hopper.

A Reference: 099377	45cm. Ø	Blue
B Reference: 099375	60cm. Ø	Red

KIN-BALL®* - AIM OF THE GAME

- Serve the KIN-BALL to one of the opposing teams so that they can't catch it before it touches the floor.
- The team who has the ball (during the service or the game) chooses one of the opposing teams (it should be the team who has the highest points) by calling her by her colour, then throws the ball toward a strategic location. When the team throws the ball, all players must be in contact with it.
- For the team who will catch the KIN-BALL, the aim of the game is to lift the ball before touching the floor and to throw it again to another team. If the players don't succeed to catch the KIN-BALL or if they make a mistake according to the rules of the game, one point is given to the two other teams.

* The KIN-BALL® brand is a third-party brand

• SKYFLOATER BALL

Valve protection system



DIAMETER 122 cm



RECYCLABLE

The Skyfloater ball has been developed for the practice of KIN-BALL®* sport. It can also be used for other cooperative games. Its durable, washable, double-stitched nylon cover ensures maximum durability of the ball, even after intensive use in a competitive environment. Under the cover, a large latex bladder gives the ball its spherical shape; it inflates and deflates quickly thanks to its wide opening. Delivered with a bladder.

Reference: 088027	Unit
-------------------	------

• COLOURED CAGE BALL

Valve protection system



2 sizes available: 85 cm and 120 cm



RECYCLABLE

Very light and resistant oversized ball, ideal for cooperative games. Its durable, washable, double-stitched nylon cover ensures the ball will last for a long time, even after intensive use. Under the cover, a large latex bladder gives the ball its spherical shape; it inflates and deflates quickly thanks to its large opening. Delivered with a bladder.

Reference: 088025	85 cm Ø
Reference: 088026	100 cm Ø

• REPLACEMENT BLADDER



Compatible with ref: 088025, 088026 and 088027

Latex replacement bladder with large opening. Ideal to use for oversized balls as the Skyfloater Ball and Coloured Cage Ball.

Reference: 088028	100 Ø and 122cm. Ø
Reference: 088003	85cm. Ø

DOUBLE ACTION PUMP

SPORTI



RECYCLABLE
HEIGHT 50 cm

Double action system, it inflates twice faster, recommended for the inflation of large balls like gymball. Delivered with different nozzles.

Reference: 044074	Unit
-------------------	------



School

Orienteering	164
Must-have for teacher	167
Hockey and street-hockey	168
Juggling	170
Throwing games	172
Throwing games and rackets	174
Throwing games, space hoppers and giant balls	175
Floor marking	176
Agility and precision kits	177
Playground and balance games	178
Road safety	180

TO DISCOVER



P.165



P.170



P.173



ECO COMPASS



WEIGHT	THICKNESS	WIDTH	LENGTH
23 g	11 mm	55 mm	90 mm

Durable plastic Compass, designed for initiation and training in schools and educational organisations. 360° graduation every 2°, with rotating capsule. The luminescent markings on the needle and arrow make it easy to find your bearings. Scale 1/10000-1/15000-1/25000, delivered with lanyard.

Reference: 086025 Unit

SCO INITIATION COMPASS WITH GREEN TRANSPARENT PLATE



WEIGHT	THICKNESS	WIDTH	LENGTH
35 g	14 mm	64 mm	90 mm

Rotating capsule. Sighting line and arrow. Large numbers easy to read. Accuracy: 2°. Graduation: 0-360°. Scale in cm, inches: 1:10 000 - 1:15 000. Delivered with lanyard.

Reference: 086040 Unit

COMPASS WITH MAGNIFYING LENS



WEIGHT	THICKNESS	WIDTH	LENGTH
52 g	17 mm	60 mm	128 mm

Very resistant plastic model, dedicated to school and training, as well as to higher educational levels. 360° graduation every 2°, with rotating capsule. The luminescent markings on the needle and the cardinal points make it easy to find your way around. Consists of a large magnifying lens, sighting arrow, and tracing templates (circle and starting triangle). Scale 1/10000-1/15000-1/25000, delivered with lanyard.

Reference: 086024 Unit

SURVIVOR COMPASS



WEIGHT	THICKNESS	WIDTH	LENGTH
43 g	15 mm	60 mm	71 mm

Graduation: 0-360°. Scale in mm, inches, with mirror, arrow and sighting hole. Adjustable declination. Protective cover for better protection and convenience.

Reference: 086043 Unit

TRAIL COMPASS WITH SIGHTING MIRROR



WEIGHT	THICKNESS	WIDTH	LENGTH
97 g	22 mm	64 mm	122 mm

With magnifying lens and luminescent markings. Graduation : 0-360°. Scale in mm, inches: 1:25 000e – 1:50 000e. With protective cover and lanyard.

Reference: 086044 Unit

HIKE PRO COMPASS

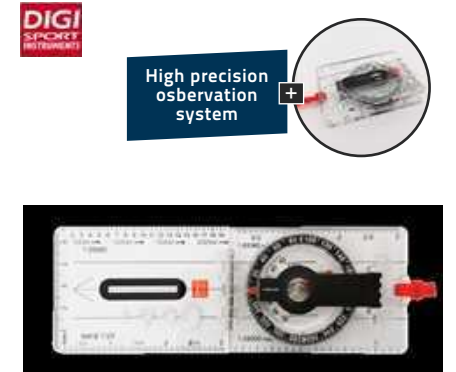

High precision observation system

WEIGHT	THICKNESS	WIDTH	LENGTH
51 g	14 mm	57 mm	155 mm

With magnifying lens and luminescent markings. Graduation : 0-360°. Scale in mm, inches: 1:25 000e – 1:63 360e – 1:24 000e. With protective cover and lanyard.

Reference: 086041 Unit

SCHOOL SET OF 16 SCO COMPASSES



WEIGHT	THICKNESS	WIDTH	HEIGHT
1 kg	80 mm	240 mm	330 mm

Ideal for a whole class. 1 hard plastic case with structured foam for 16 SCO compasses included.

Reference: 086045 Set

SCHOOL CASE 24 SCO COMPASSES



WEIGHT	THICKNESS	WIDTH	HEIGHT
1.3 kg	80 mm	240 mm	330 mm

Ideal for a whole class. 1 hard plastic case with foam insert and 24 SCO compasses.

Reference: 086046 Set

ORIENTEERING CASE 16/24 ECO COMPASSES



LENGTH	WIDTH
37 cm	30 cm

Set including 1 case and 16 or 24 Eco compasses (ref : 086025).

Reference: 086047 Set of 16

Reference: 086048 Set of 24

STOPWATCH WATCH



1 timing line - Accuracy 1/100sec - Timing time: 24H 12-24H clock / alarm / date mode - Backlighting of the screen - Splash proof - Dial diameter 50mm - Digits height: 10/4mm . - 63gr.

Reference: 024001

Unit

MECHANICAL COMPASS



WEIGHT	THICKNESS	WIDTH	LENGTH
24 g	16 mm	45 mm	96 mm

Allows you to measure mileage on a map.
Material: plastic and metal.

Reference: 086035

Unit

SET OF 10 COLOURED CONTROL PUNCHES

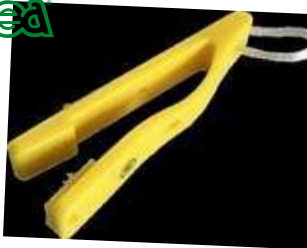

Set of 10 clips with different punches forms for the control marking in competition and training. Available in 4 sets of different punches: A / B / C / D.

Reference: 086030

A model - Yellow

Reference: 086031

B model - Blue

Reference: 086032

C model - Red

Reference: 086033

D model - Orange

COLOURED CHECKPOINT MARKERS



A MODEL



B MODEL



C MODEL



D MODEL



LENGTH	WIDTH
15 cm	15 cm

Set of 10 plastic checkpoint markers 15 x 15 cm, not sensitive to humidity and very resistant. 4 colours schemes for team courses or variable difficulties. Each set is numbered from 1 to 10 with a different code on each card to copy on your control card.

Reference: 086021

Set of 10 coded markers

Reference: 086037

Kit of 40 markers (A model + B + C + D)

SET OF 5 CHECKPOINT MARKERS



Triangular checkpoint marker in orange and white nylon.

Reference: 086002

Dim 15 x 15 cm

Reference: 086002A

Dim 30 x 30 cm

SET OF 50 CONTROL ORIENTEERING CARDS



LENGTH	WIDTH
19 cm	9 cm

Set of 50 control cards for orienteering.

Reference: 086007B

Unit

SET OF 50 TEARPROOF CONTROL ORIENTEERING CARDS



LENGTH	WIDTH
19 cm	9 cm

Set of 50 tear-proof control cards for orienteering.

Reference: 086034

Unit

MAP-HOLDER



LENGTH	WIDTH
30 cm	28 cm

In plastic, with a closure by self-grabbing. With support guiding line.

Reference: 086036

Unit



Sports bags, storage and transport
Multisports
Tracing and ground accessories
Coach, referee and player
First-aid
Fitness, bodybuilding and gym
Swimming
Combat sports
Racket sports
Athletics
Balls
School
Nets and accessories

ORIENTEERING KIT

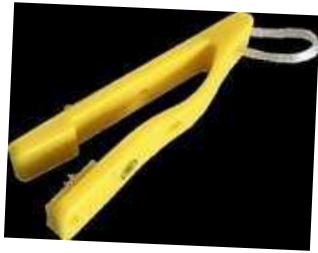

10 control punches

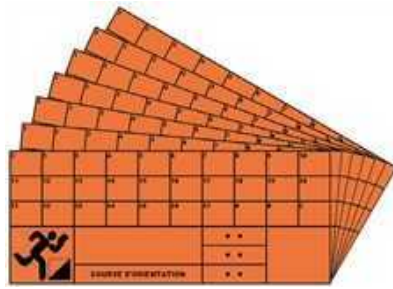

50 control orienteering cards



10 checkpoint markers



Kit composed of a set of 10 A model control punches, a set of 50 control orienteering cards and 10 checkpoint markers 15 x 15 cm.

Reference: 086028

Kit

EDUCATIONAL BOX



Complete educational set for introduction to orienteering including: 10 compasses ref 086025, 10 markers 15 x 15 cm, 10 control punches, 50 control orienteering cards, 1 whistle + lanyard and 1 storage case.

Reference: 086029

Set

COMPASSE CASE



LENGTH 37 cm WIDTH 30 cm

Briefcase with handle and handle. Removable foam.

Reference: 024070

Unit

CHALK-BASED MARKING SPRAY



Maximum duration: 1 month



Ephemeral chalk-based spray paint ideal for very short-term floor markings. For signaling and beaconing sporting events (races, hikes) or any type of event: flea markets, markets, shows, leisure. Available in blue, pink and orange.

Reference: 060094

Unit

TEMPORARY MARKING SPRAY



Maximum duration: 2 months



Temporary spray paint that is used for floor markings that should not last. Particularly suitable for markings in urban areas or on classified or protected sites. Available in red, white and orange.

Reference: 060093

Unit

FLAGGING TAPE 100 M



LENGTH 100 m WIDTH 5 cm

Colour: Red/White.

Reference: 069080

Unit

FLAGGING TAPE 500 M



LENGTH 500 m WIDTH 5 cm

Colour: Red/White.

Reference: 069081

Unit

SPECIAL CONE WITH ONE STRIP



RECYCLABLE WIDTH 24 cm

Square base of 14 cm stable and very visible, in polyethylene.

Reference: 063331

Unit

• RIGID BRIEFCASE N°2



Size	
w.	24 cm
L.	32 cm

Reference: 063461 - Unit



• RIGID DOCUMENT HOLDER WITH ERASABLE FACE



* Pencils not included

Size	
w.	24 cm
L.	32 cm

Reference: 063489 - Unit



• PRO RIGID BRIEFCASE



Size	
w.	24 cm
L.	34 cm

Reference: 063463 - Unit



MEGAPHONE **S**SPORTI



W.	1.2 kg
----	--------

Size	
Ø	20.5 cm
L.	34 cm

Made in ABS, sturdy yet light weight. Clear sound, long range (500 m). Conveniently located volume control and switch for a simple use. Power output: 30 W. Power source: 6 x batteries 1.5 V R14 (not included).

Reference: 024048

Unit



ELECTRONIC WHISTLE



Electronic whistle with manual control. This kind of article is voted in by physical education teachers because it is more hygienic. 2 different tones. Ergonomic design, light and robust. Delivered with cordon. Works with 4 CR2032 batteries included. Decibel: max. 125 DB.

Reference: 063485

PLASTIC WHISTLE + LANYARD



Reference: 063193

Unit



HAND WHISTLE



Hand whistle, perfect for several users to maintain hygiene, effortlessly loud sound and strident. Available in colours: Red, Blue, Purple and Orange. Antimicrobial surface treatment.

Reference: 063153

Unit

POSTER SUPPORT **S**SPORTI



internal Ø
25 mm

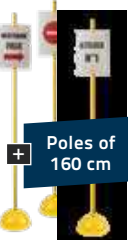

Poles of
160 cm



Transparent poster support to facilitate your communication both outside and inside. You will slide your A4 papers in two seconds thanks to a clips system. You can fix it very quickly on any pole or slalom pole. Sold in set of 5.

Reference: 063408 Set of 5 supports

Reference: 063403 The kit (5 supports + 5 poles of 160 cm + 5 bases)

WHITE TACTIC BOARD **S**SPORTI



LENGTH	WIDTH
90 cm	60 cm

Blank rigid tactic board. Support base included to put your pencils, magnets, etc. Delivered without accessory.

Reference: 063210 Unit



PORTABLE MAGNETIC BOARD **S**SPORTI



Unfolded view

2 sizes:
45 x 60 cm
60 x 90 cm

Board easy to use, transportable thanks to its handle. Delivered without magnetic pawn.

Reference: 063445A Size: folded 45 x 60 cm
Reference: 063445B Size: folded 60 x 90 cm



Sports bags, storage and transport

Multisports

Tracing and ground accessories

Coach, referee and player

First-aid

Fitness, bodybuilding and gym

Swimming

Combat sports

Racket sports

Athletics

Balls

School

Nets and accessories

STREET HOCKEY BALL



DIAMETER
65 mm

Ball for the practice of street hockey.

Reference: 089004U Unit

STREET HOCKEY PUCK



DIAMETER
75 mm

Reference: 089005U Unit

Reference: 089040 Set of 12

UNIHOKEY BALL



RECYCLABLE

DIAMETER
70 mm

Openwork ball to practice hockey.

Reference: 089035U Unit

STREET HOCKEY STICK



For introduction and practice of street hockey. 2 colours (blue and red).

Reference: 089065C

Handle: 80 cm

Reference: 089066C

Handle: 100 cm

UNIHOKEY STICK



Handle
L. 85 cm

Reinforced PVC stick. Available in yellow and red colour.

Reference: 089036 Unit

UNIHOKEY KIT

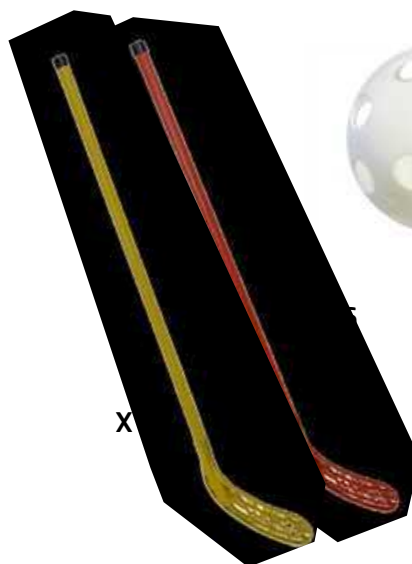

X 12

Handle
L. 85 cm

This kit includes 12 unihokey sticks (6 yellow and 6 red) and 12 balls.

Reference: 089051

Kit

RECYCLABLE

**KIT OF 6 STREET HOCKEY STICKS
PRIMARY SEA**



This kit includes 6 hockey sticks of 80 cm length (3 red and 3 blue), 1 hockey ball and 1 hockey puck.

Reference: 089071

Kit

**KIT OF 6 STREET HOCKEY STICKS
SECONDARY SEA**



This kit includes 6 hockey sticks of 100 cm length (3 red and 3 blue), 1 hockey ball and 1 hockey puck.

Reference: 089072

Kit

**KIT OF 12 STREET HOCKEY STICKS
PRIMARY SEA**



Street hockey primary kit composed of 12 sticks. L = 80 cm + 1 ball + 1 puck.

Reference: 089057

Kit

**KIT OF 12 STREET HOCKEY STICKS
SECONDARY SEA**



Street hockey secondary kit composed of 12 sticks. L = 100 cm + 1 ball + 1 puck.

Reference: 089058

Kit

PACK STREET HOCKEY PRIMAIRE SEA

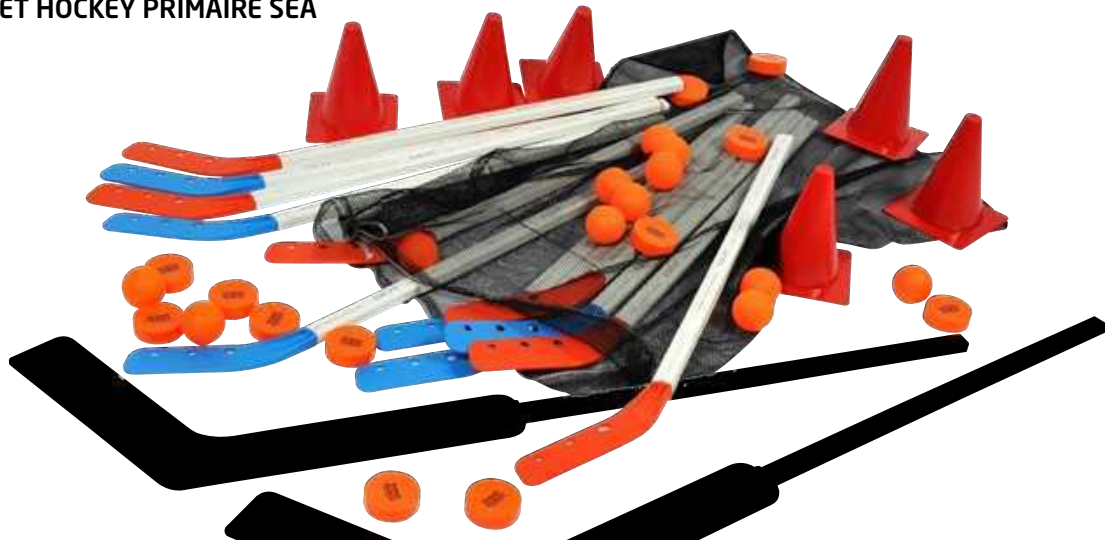

Street hockey primary pack is composed of 12 primary sticks. L = 80 cm + 12 balls + 12 pucks + 6 markers of 20 cm + 1 bag.

Reference: 089059

Kit



Sports bags, storage and transport
Multisports
Tracing and ground accessories
Coach, referee and player
First aid
Fitness, bodybuilding and gym
Swimming
Combat sports
Racket sports
Athletics
Balls
School
Nets and accessories

JUGGLING BALLS ECO



RECYCLABLE
WEIGHT 80 g
DIAMETER 62 mm

Perfect ball for a first introduction to juggling. PVC and plastic beans, 62 mm diameter, weight 80 gr. Delivered in a plastic sachet.

Reference: 082002 Set of 3

JUGGLING BALLS SENIOR



RECYCLABLE
WEIGHT 120 g
DIAMETER 62 mm

Flexible ball and pleasant to the touch. PU cover and millet seeds. Delivered with its cardboard box.

Reference: 082004 Set of 3

JUGGLING BALLS JUNIOR



RECYCLABLE
WEIGHT 80 g
DIAMETER 55 mm

Flexible ball and pleasant to the touch, it is advised to begin or in a school environment. PU cover and millet seeds. Delivered with its cardboard box.

Reference: 082003 Set of 3

PVC BEANBAG BALLS

More hygienic



RECYCLABLE
WEIGHT 90 g
DIAMETER 65 mm

The first stage ball which brings the flexibility of bean bags (filled of plant seeds). Besides, its PVC coating in test of time is more hygienic than any ball because it is washable. For all jugglers and all figures. Antimicrobial surface treatment. Available in 6 colours (Blue, Yellow, Green, Red, Purple and Orange).

Reference: 082061 Unit

SET OF 3 JUGGLING CLUBS



RECYCLABLE
WEIGHT 175 g
LENGTH 44.5 cm

Ideal for introduction from 7 years old. The fancy «silver» stick allows to increase relief to his shows, it is flexible to absorb the shocks and has a better prehension of the club. Club moulded, 1 body to 2 flexible end pieces. Matching colours Blue / Red and Yellow.

Reference: 082087 Set of 3

JUGGLING SCARVES



Nylon scarves for learning juggling very softly. Thanks to their very slow movements, they allow to break the gestures down. Very eye-catching the juggling scarves are highly suitable for the show. Dimensions: 65 cm x 65 cm (6 colours: orange, pink, red, green, yellow and blue).

Reference: 082084 Unit - 65 x 65 cm

Reference: 082084L Set of 3 - blue, yellow, pink

JUGGLING RINGS JUNIOR

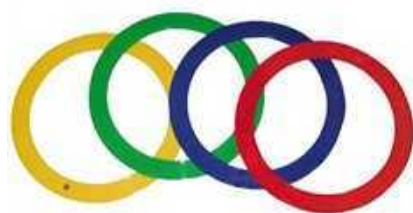

Junior
Ø 24 cm
W 70 g

RECYCLABLE

To juggle alone or in a group. Polypropylene rings with curved edges. Sold by the unit.

Reference: 082062 Junior Yellow/Green/Blue/Red

JUGGLING RINGS SENIOR

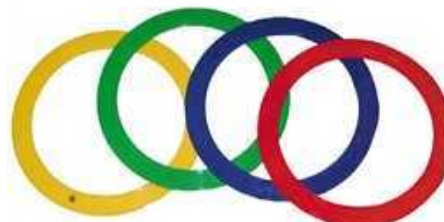

Senior
Ø 32 cm
W 100 g

To juggle alone or in a group. Polypropylene rings with curved edges. Sold by the unit.

Reference: 082062B Senior Yellow/Green/Blue/Red

• DIABOLO + ALU STICKS



+
Delivered with aluminum sticks.
Length: 32.5cm / Weight: 77gr.



WEIGHT	DIAMETER	LENGTH
215 g	10.5 cm	12 cm

Perfect model for introduction. Rigid plastic body and a screwed axis, delivered with a pair of sticks and a booklet. Available in 3 colours: Red, Turquoise and Green.

Reference: 082006 Unit

ROLLA BOLLA



Roll	
w.	40 cm
Ø	11 cm

RECYCLABLE		
THICKNESS	WIDTH	LENGTH
3.6 cm	28 cm	73.5 cm

Composite balance board of dimensions 73.5 x 28 cm, thickness 3.6 cm with a non-skid surface. PE roll of 40 cm, 11 cm Ø. Maximum user weight: 160kg.

Reference: 082005 Unit

FUN DEVIL STICK

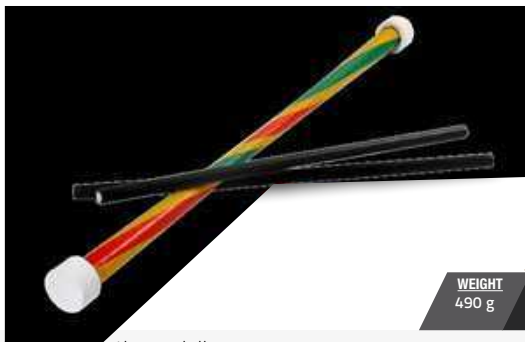

RECYCLABLE	
WEIGHT	LENGTH
490 g	76 cm

Perfect for introduction and discovery. Conical devil stick, 2 rubber sticks.

Reference: 082091 Unit

• CHINESE PLATE + STICK



+ Soft material limiting breakage



+
Delivered with a stick

WEIGHT	DIAMETER
100 g	23 cm

Ideal for school shows, this exercise that requires agility and concentration fascinates and amazes. Includes a soft plate, 2-piece baguette for easy storage and a transport net. Available in 3 colors: Red, Yellow and Blue.

Reference: 082007 Unit

BOLAS



Ribbons	L. 135 cm
Cords	L. 50 cm

RECYCLABLE	
WEIGHT	
104 g	

Perfect for all (beginners and experienced) the bola provides a superb visual effect thanks to the large trains. Finger stability with an adjustable length wire and an anti-twisting swivel hook.

Reference: 082013 Pair

Sports bags, storage and transport
Multisports
Tracing and ground accessories
Coach, referee and player
First aid
Fitness, bodybuilding and gym
Swimming
Combat sports
Racket sports
Athletics
Balls
School
Nets and accessories

BEGINNER KIT TARGET 1 M X 1 M + SET OF 10 NUMBERED BAGS



Bag	
W.	100 gr.
D.	12x12cm

KIT

This kit includes 1 target 1 m x 1 m and 1 set of 10 multicoloured filled bags numbered from 1 to 10. Adapted for schools.

Reference: 099260

Reference: 099202

Reference: 099205F

Kit

Single target

Set of 10 bags

MULTICOLOURED SET OF 20 SOFT PUCKS



2026
NEW



RECYCLABLE	
THICKNESS	DIAMETER
1.5 cm	9.5 cm

WEIGHT	SIZE
155 g	16x16x 16 cm

Set of 20 PVC discs. 5 discs per colour, 4 colours: Yellow, Blue, Green, and Red.

Reference: 089003

Set

HIGH DENSITY FOAM DICE



In high density polyurethane foam. Faces numbering from 1 to 6. Available in 3 colours (Yellow, Red, Blue).

Reference: 099300

Unit

• AEROBIC SUPERDISK

• AEROBIC SPRINT RING

BOOMERANG



DIAMETER
25 cm

The superdisc allows a long and straight flight, easy to throw, ideal for all levels. Soft edge for an optimal catch in hand. It floats on the water therefore it can be used in aquatic environment. Matching colours.

Reference: 099303

Unit



DIAMETER
25 cm

The Sprint Ring allows a flight of long distances with different techniques of taking in hand thanks to its specific form. Matching colours.

Reference: 099302

Unit



RECYCLABLE

Plastic boomerang, ideal for introduction to circular path. Matching colours.

Reference: 099074

Unit

GOAL FOR FLYING DISCUS



Delivered with 6 discus +

Target
H. 37 cm
L. 77 cm



This goal for flying discus is an ovoid target adjustable at 3 different heights: from 130 to 150 cm. The base can be weighted with water or sand. It offers many games combinations, used alone as a target or by two during precision trials. Delivered with 3 red and 3 blue discus (weight 87g, Ø 23cm). Tubes Ø 32mm and 36mm in lower part.

Reference: 081016 Unit

INTRODUCTION TARGET

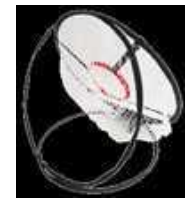

Easy to use, easy to carry, easy to store, this target to put on the floor can be folded and unfolded in no time thanks to a clips system. Delivered with anchor pegs.

Height putting on the floor: 47 cm.
Diameter of the large target: 62 cm / Diameter of the little target: 22 cm.

Reference: 099376 Unit

SOFT FOAM FLYING DISCUS



WEIGHT	95 g
DIAMETER	21 cm

Foam flying discus to discover safe the pleasures of throw. Available in Green, Yellow, Red and Blue.

Reference: 099210 Unit

LEISURE FRISBEE



Matching colours

WEIGHT	78 g
DIAMETER	21 cm

Plastic discus. Available in 4 colours: Blue / Green / Red / Yellow.

Reference: 099221 Unit

FLYING DISK CERTIFIED BY THE FFDF



WEIGHT	150 g
DIAMETER	24 cm

PVC flying disk certified by the FFDF.

Reference: 099245 Unit

FOAM FLYING RING



WEIGHT	80 g
DIAMETER	21 cm

Material: high density foam. Extended lifetime (excellent abrasion resistance). Available in 2 colours: Blue and Red.

Reference: 081013 Unit

DECK-TENNIS RING



WEIGHT	200 g
DIAMETER	18 cm

Throwing ring very flexible, adapted to the younger ones. Available in 4 different colours: Blue / Green / Red / Yellow.

Reference: 099071U Unit
Reference: 099071R Set of 12

THROWING RING

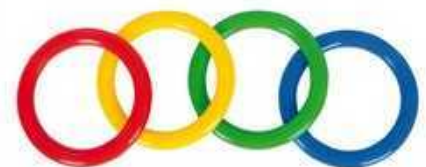

WEIGHT	15 g
DIAMETER	14,5 cm

Available in 4 different colours: Blue / Green / Red / Yellow.

Reference: 099070U Unit
Reference: 099070R Set of 12

SET OF 2 MINI-TENNIS RACKETS + 2 BALLS



RECYCLABLE

Set containing 2 ABS mini-tennis rackets 40 cm (1 blue and 1 orange) and 2 foam balls 70 mm diameter.

Reference: 099154R Set

MINI-TENNIS EDUCATIONAL KIT

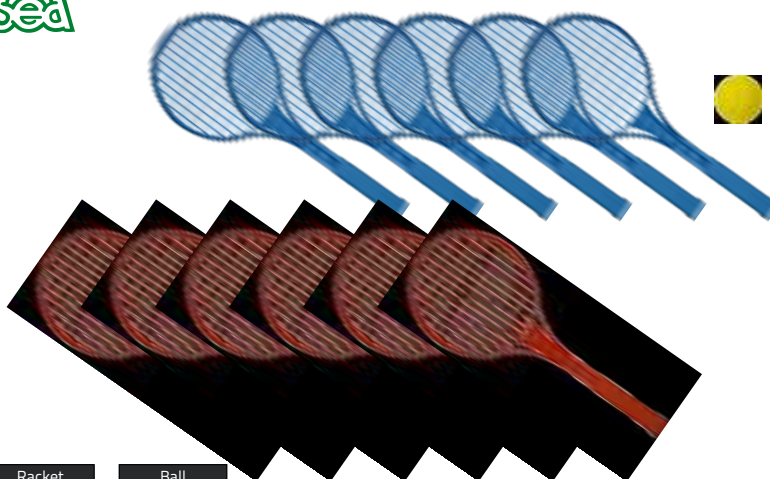

X 12

Racket	Ball
L. 40 cm	Ø 70 mm

RECYCLABLE

Composed of 6 orange plastic rackets, 6 blue and 12 softy foam balls.

Reference: 099073R Kit

SET OF 2 BEACH BALL RACKETS



Set of 2 beach ball rackets. Material: moulded polyethylene. Delivered with a ball. Matching colours.

Reference: 099072 Pair

CATCHER BALL GAME



Ball	Catcher
Ø 6 cm	Ø 18.5 cm

Recreational activity, which develops skill and agility, the ball stays stuck to surfaces thanks to auto-gripping coating. Delivered with a ball.

Reference: 099038 Unit

TOPKARI GAME



Game of 2 wooden rackets and one rubber ball connected to the base by an elastic. It allows to work coordination and liveliness.

Reference: 099258 Set

INITIATION INDIKA



RECYCLABLE

Ideal model for learning Indika. Excellent value for money. Shuttlecock in natural plumes with a soft foam end piece. Matching colours.

Reference: 081001 Unit

CESTAS



RECYCLABLE

Set composed of 2 Cestas and a ball, this game is perfect to develop player's manual and visual coordination.

Reference: 099141 Set

SET OF FLYING BALL



Composed of 2 «flying-balls» with foam handles for greater comfort and a ball of 70 mm, this game allows to 2 players to knock the ball up in a fun way.

Reference: 099142 Set

• MINI VORTEX



WEIGHT 40 g LENGTH 17 cm

It allows to discover the pleasures of throw. Very appreciated by children due to its manoeuvrability.

Reference: 099215U Unit

COMET BALL

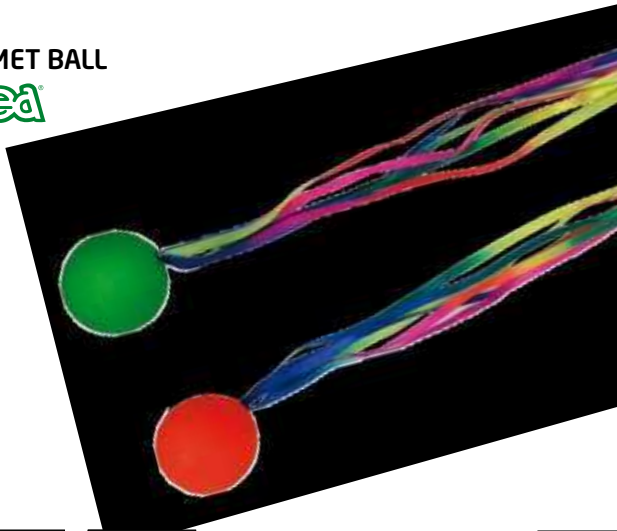

Ball	Ribbon
Ø 65 mm	H. 65 cm

WEIGHT 74 g

Ideal for learning throw. Rubber ball. With multicoloured ribbons.

Reference: 099247 Unit

SPACE HOPPER



Inflatable space hopper. Flexible and thick plastical material. Ergonomic handle and cork.

A Reference: 099377	Ø 45cm.	Blue
B Reference: 099375	Ø 60cm.	Red

• VORTEX JAVELIN

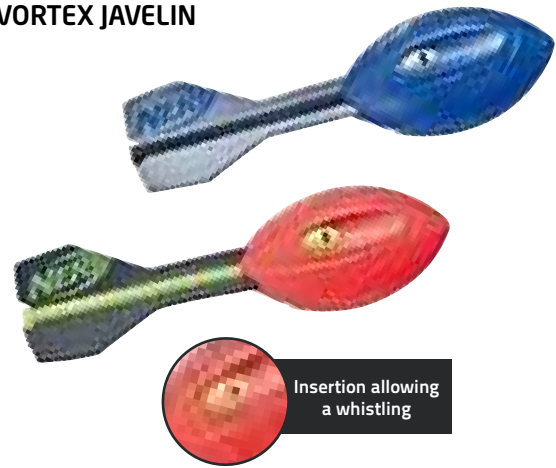

Insertion allowing a whistling

WEIGHT 125 g LENGTH 33 cm

Especially designed for the introduction to throws, the vortex is fun thanks to the whistling during its flight and securing with its foam material. Matching colours.

Reference: 099051 Unit

FOAM JAVELIN

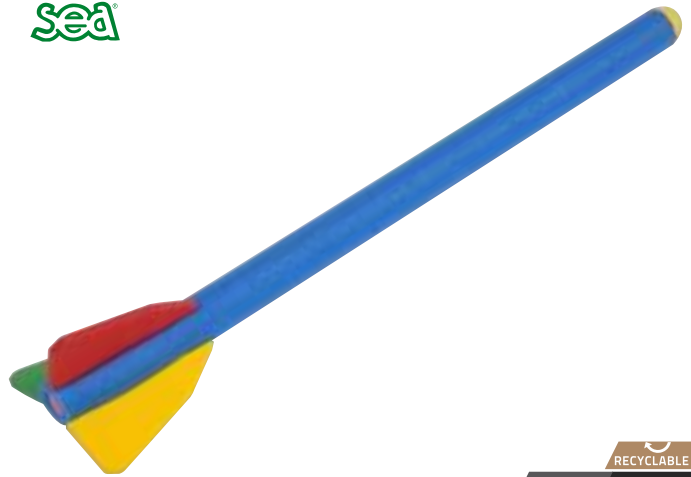

WEIGHT 110 g LENGTH 90 cm

Foam javelin of high density, slightly weighted on the front.

Reference: 099050 Unit

GIANT BALL



75 cm delivered with 2 bladders +

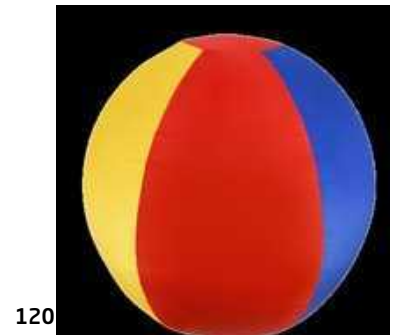

75 CM

120



Giant ball with a low rebound. Adapted for motor skills of children, it allows the improvement of the eye-hand coordination. Ultra-light.

Reference: 099271	Ball with 2 bladders	75 cm Ø
Reference: 099274	Ball with 1 bladder	120 cm Ø
Reference: 099272	The bladder	75 cm Ø
Reference: 099273		120 cm Ø



Sports bags, storage and transport
 Multisports
 Tracing and ground accessories
 Coach, referee and player
 First-aid
 Fitness, bodybuilding and gym
 Swimming
 Combat sports
 Racket sports
 Athletics
 Balls
 School
 Nets and accessories

FLOOR MARKING

CASE FOR MOTOR ABILITY



Floor marking, on pages 22-23

Transparent case containing 32 vinyl pieces in 4 different colours (4 pairs of feet, 4 pairs of hands, 4 triangles, 4 circles and 8 arrows). Allows to understand the notions of balance, of shapes and colours.

Reference: 069215 Unit

CASE FOR PSYCHOMOTOR COURSE



Transparent case containing 36 vinyl pieces in 4 different colours (4 pairs of feet, 4 pairs of hands, 4 floor marking tapes, 8 corner markers and 8 arrows). Allows to create psychomotor courses by mixing feet, hands and varied shapes of different colours. Supplied with instruction booklet.

Reference: 069214 Unit



GROUND MARKERS WITH NUMBERS



DIAMETER	THICKNESS
20.5 cm	3 mm

Ground marking with numbers from 1 to 10. Nonskid flexible rubber.

Reference: 062981 Unit

FLOOR MARKING KIT



This kit includes: 4 round markers, 4 corner markers, 4 floor marking slats, 4 vinyl arrows, 2 pair of hands, 2 pair of feet.

Reference: 069089 Kit

BOX OF 7 GIANT CHALKS



LENGTH 19 cm

Box with 7 chalks to draw concrete and asphalt. 7 colours.

Reference: 060095 Unit

SLACKLINE



Strap	
w.	50 mm
L.	15 m

Elastic strap in yellow polyester of 15 m reserved for the practice of the Slackline. The strap is fixed thanks to a polyester tether strap of 2 m length with protected loops. Maximum weight per user: 90 kg. Maximum load: 3.000 kg. Inside or outside use.

Reference: 099306 Unit

• TACTILE GAME 1



RECYCLABLE

5 tactile structures are available in the form of a large plate to put on the floor and a little plate to hold in his hand. This set includes 5 large plates (27 cm diameter), 5 little plates (11 cm diameter), a blindfold for eyes and a cloth bag.

Reference: 099135

Kit

• SET OF 6 RIVER STONES



RECYCLABLE

These accessories with a triangular shape looking like rocks have sides with variable slopes that offer several degrees of difficulty. You just have to jump from one stone to another one without touching the floor. Each stone has to its base non-skip rubber pads that also protect inside floor. The river stones can be piled up to facilitate the storage. Games ideas included. This set is composed of 3 large stones 36 x 36 x 36 cm, height: 8.5 cm and 3 little stones 25 x 25 x 25 cm height: 4.5 cm. Maximum load 75 kg.

Reference: 099132

Kit

INTRODUCTION KIT



RECYCLED
RECYCLABLE

This kit allows to compose a short course of motor ability by mixing passages under a pole, stepping over obstacles, jumps... It is composed of:
-6 fillable bases
-10 poles of 1 m
-4 flat hoops (40 cm, 50 cm, 60 cm and 70 cm) in matching colours
-12 multi-use clips.

Reference: 099326

Kit

TARGETS MOTOR ABILITY



RECYCLED
RECYCLABLE

It includes:
-3 split cones 30 cm H. drilled 8 holes
-3 split cones 50 cm H. drilled 12 holes
-3 poles 1.20 m
-3 flat hoops 40 cm in diameter
-6 flat hoops 50 cm in diameter
-6 multi-use clips
-3 foam rugby balls
-6 foam balls 7 cm in diameter
-1 seaman bag in openwork stitches.

Reference: 099327

Kit

MULTI-ACTIVITIES MOTOR ABILITY KIT

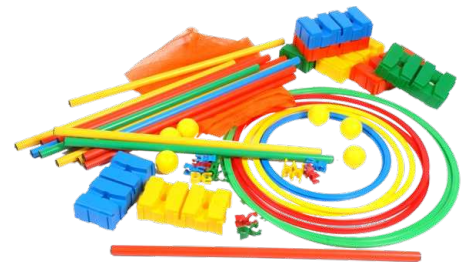

RECYCLED
RECYCLABLE

The different hoops diameters allow to vary the games' difficulty. It includes:
-8 multi-activities bricks
-16 poles of 80 cm
-8 flat hoops 40 and 70 cm in diameter
-20 multi-use clips
-6 foam balls 9 cm
-1 seaman bag in openwork stitches.

Reference: 099328

Kit

DEXTERITY



RECYCLED
RECYCLABLE

An ideal kit for learning throwing on targets: varieties of heights and diameters are adjustable. Items to throw allow to children to discover different ways of throwing. In addition to these games of skill, a motor ability course can be composed with different obstacles. This kit includes:

- 6 split cones 30 cm H. drilled 8 holes
- 3 split cones 50 cm H. drilled 12 holes
- 10 poles 80 cm + 2 poles 1 m
- 5 flat hoops 40 cm in diameter
- 3 flat hoops (50 cm, 60 cm and 70 cm)
- 12 multi-use clips
- 3 foam mini-javelins
- 4 foam balls 7 cm in diameter
- 2 foam balls 17.5 cm in diameter
- 1 seaman bag in openwork stitches.

Reference: 099330

Kit

CROSSING



RECYCLABLE

This complete kit allows to create different exercises for several motor activities: jumps, stepping over obstacles, crawling, speed... A course with alternation of slow and quick parts by combining obstacles of different natures and heights. You can also realise many combinations. It includes:

- 1 set of 20 extra-flexible markers with notches
- 6 split cones 50 cm H. drilled 12 holes
- 10 poles of 1.20 m
- 14 poles 1 m
- 8 poles 80 cm
- 24 multi-use clips
- 4 flat hoops 70 cm in diameter
- 8 fillable bases
- 1 seaman bag in openwork stitches.

Reference: 099331

Kit

STRAIGHT BALANCE BEAM, CURVE AND INTERSECTION



It is possible to combine straight beams, curved beams and to modify paths with intersections. Very easy to assemble and remove, matching colours.

Reference: 099123U	Straight beam	Unit
Reference: 099124U	Curved beam	Unit
Reference: 099125U	Intersection	Unit

MULTI-ACTIVITIES BRICK

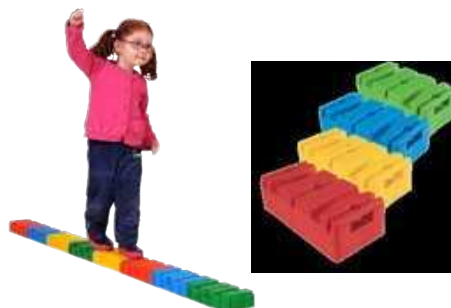

Brick	
w.	15 cm
L.	31 cm
H.	10 cm



They interlock, pile up, grip on all sides to do obstacles, routes, balance beams, constructions, etc. Used alone or in combination with poles and flat hoops. Available in 4 colours (red/yellow/green/blue). Material: plastic. The roof for brick interlocks on the SEA bricks to form a semi-spherical set. Non-skid grainy surface to stimulate touch and balance.

Reference: 099322	Set of 12 bricks	Matching colours
Reference: 099323	Set of 24 bricks	Matching colours
Reference: 099324	Set of 40 bricks	Matching colours

BALANCE PLATFORM



RECYCLED	
RECYCLABLE	
DIAMETER	HEIGHT
39.5 cm	8 cm

Perfect to develop the static balance. Wooden board with non-skid surface. Half sphere for the first feeling balance. Maximum user weight: 110kg.

Reference: 082027	Unit
-------------------	------

ROLLA BOLLA



Balance board		Roll	
w.	28 cm	w.	40 cm
L.	73.5 cm	Ø	11 cm



Composite balance board of dimensions 73.5 x 28 cm, thickness 3.6 cm with a non-skid surface. PE roll of 40 cm, 11 cm Ø. Maximum user weight: 160kg.

Reference: 082005	Unit
-------------------	------

PEDALO WITH 4 WHEELS



Very stable, to get safe balance exercises while having fun and move freely.

Reference: 082031	Unit
-------------------	------

NON-SLIP PAIR OF STILTS IN PVC



RECYCLED	
RECYCLABLE	
DIAMETER	HEIGHT
11 cm	12 cm

Cylindrical shape for a better introduction to balance and motor activities. Non-skid rubber base. Colour: red and blue cord.

Reference: 082073	Pair
-------------------	------

Sports bags, storage and transport
 Multisports
 Tracing and ground accessories
 Coach, referee and player
 First aid
 Fitness, bodybuilding and gym
 Swimming
 Combat sports
 Racket sports
 Athletics
 Balls
 School
 Nets and accessories

PARACHUTE



It allows to work group cohesion and movements coordination of each participant. In nylon canvas of different colours. Delivered with an individual bag. Available in 2 sizes: 6 m diameter with 16 handles, 3.50 m diameter with 12 handles.

Reference: 099120 Ø 3.5m.
Reference: 099121 Ø 6m.

SET OF 6 PETANQUE BALLS IN PVC



Set composed of 6 petanque balls and a «jack» to practice boules safety.

Reference: 099231 Unit

SACK RACE



Set of 6 sacks of different colours numbered from 1 to 6, made of nylon very resistant with double seams and 2 handles. Ideal for a coordination work and balance.

Reference: 099235 Set of 6 bags

3 M ELASTIC



Elastic game, perfect for playgrounds.

Reference: 044057 Unit

TUNNEL



DIAMETER 60 cm LENGTH 1.80 m

Very fun, this tunnel of 1.80 m length and 60 cm diameter will make the youngest happy. Carrying bag included. Easily foldable.

Reference: 099250 Unit

SET



After threading his leg into the ring, the goal of the game is to spin the ball around you without touch the string with his other leg. Perfect for a coordination work. Matching colours.

Reference: 063242 Set of 6

SET OF BUCKET, SHOVEL AND FLEXIBLE ACCESSORIES



Beach set composed of a shovel, a sieve and a flexible bucket to avoid any risk of injury.

Reference: 099233 Unit

Sports bags, storage and transport
Multisports
Tracing and ground accessories
Coach, referee and player
First-aid
Fitness, bodybuilding and gym
Swimming
Combat sports
Racket sports
Athletics
Balls
School
Nets and accessories

SCHOOL TRAFFIC LIGHTS

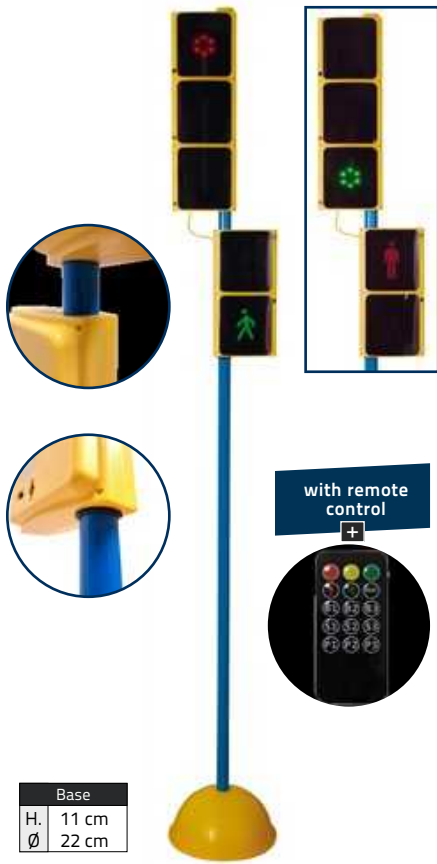

Base	
H.	11 cm
Ø	22 cm
Pole	
Ø	25 mm
L.	160 cm

Set made of a traffic light for vehicles and a pedestrian light. 9 automatic programs to simulate real traffic conditions. Possibility to light each symbol individually. Works with 6 AA batteries (not included). Remote control included. Available as a kit with a 160cm pole and a rigid fixing base.

Reference: 099351 Signaling system
 Reference: 099378 Set with 1 Pole + 1 base



These road signs are designed for an introduction to the highway code. They allow to do some circuits to make in skates, bike, scooter and so on. Models with supports are delivered with plastic poles and fillable bases. These circuits are easy to mount and dismantle therefore they can be modified very often.

Road signs

Obligations	Dangers	Bans
<p>1 Turn-right</p>	<p>5 Right-hand curve</p>	<p>10 Overtaking</p>
<p>2 Turn-left</p>	<p>6 Priority on the right</p>	<p>11 No parking</p>
<p>3 Roundabout</p>	<p>7 Priority on the right</p>	<p>12 No parking</p>
<p>4 Go straight on</p>	<p>8 Children at play</p>	<p>13 On turning right</p>
	<p>9 Pedestrian crossing</p>	<p>14 On turning left</p>
		<p>15 STOP</p>
		<p>16 No bicycle</p>

Reference: 099372

Unit - to choose

ROAD SIGNS SET + SUPPORT

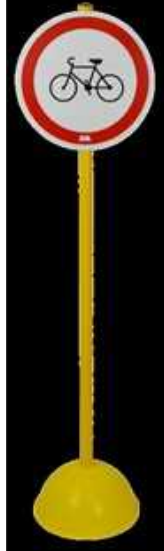

Base	
H.	11 cm
Ø	22 cm
Pole	
Ø	25 mm
L.	100 cm

Kit composed of a pole, a base and a road sign to choose among 16 possibilities (ref: 099372).

Reference: 099373 Set to choose



POSTER SUPPORT



intgernal Ø	25 mm
-------------	-------

Ref: 063408

Set of 5 supports
 The kit (5 supports + 5 poles of 160 cm + 5 bases)



Nets and accessories

FOOTBALL	182
Nets accessories	182
Football for 8	183
Football for 11	184
BASKETBALL	186
Nets	186
HANDBALL	187
Nets	187
VOLLEYBALL	188
Nets	188
Antennas, Volleyball and beach Volleyball accessories	189
TENNIS	190
Nets	190
BADMINTON	191
Nets and ball stop nets	191

TO DISCOVER

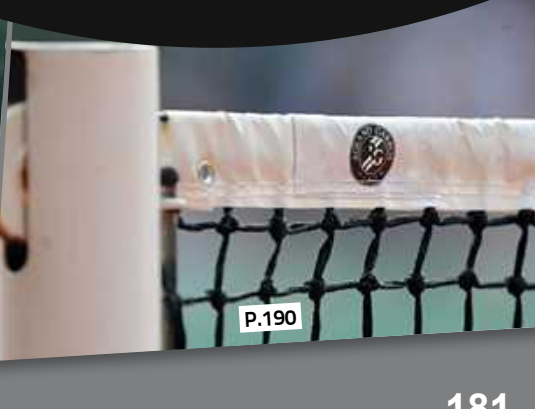

HOW TO CHOOSE A NET?

1. MATERIAL

POLYETHYLENE (PE)

- For outdoor / indoor use
- UV resistant material
- Nets mostly knotted for a better hold of the net

POLYPROPYLENE (PP)

- For outdoor / indoor use
- UV resistant material
- Nets more flexible, knotless

2. TWISTED OR BRAIDED

PE TWISTED TWINE

- For training and leisure
- The strands are «twisted» to compose the thread

PE BRAIDED TWINE

- For competition, intense uses
- The strands are «braided» to compose the thread
- Has greater flexibility than the twisted

3. SQUARE MESH SIMPLE OR DOUBLE

Double square mesh offers shock resistance higher than a simple square mesh.

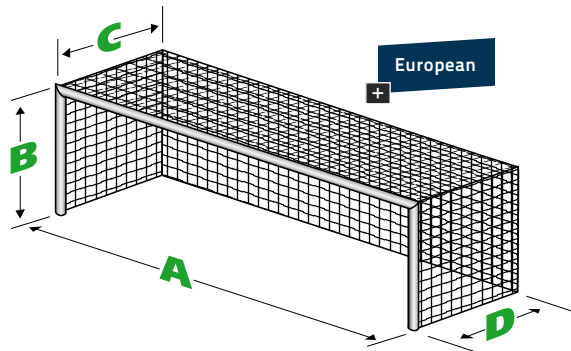
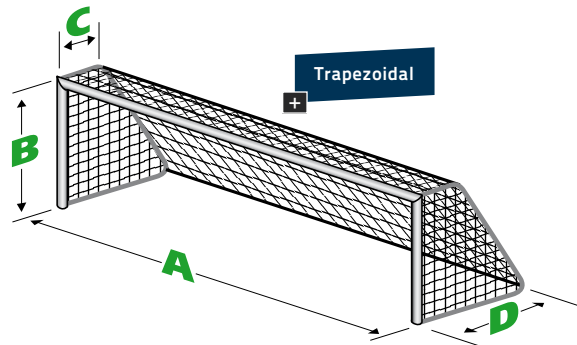

SIMPLE MESH

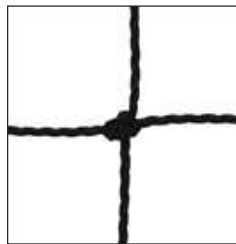

DOUBLE MESH

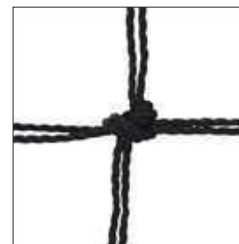

ACCESSORIES:

25 M. STRAP ROLL / REF: 022008



- To fix the net on the goals.
- Bobbin of 25 m. red

Unit:

SET OF 26 METAL PEGS / REF: 060146

- To fix the net on the field.

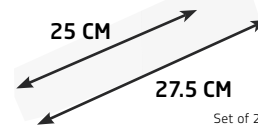

SANDOWS 10 MM Ø (SET OF 4)
REF: 022110

- With buckles.
- Length: 50cm.



Set of 4:

• HOOK FOR STEEL GOAL (WITH SCREW)



Hook very resistant. For steel goal with screw.

Reference: 060042 Unit

• HOOK FOR ALU GOAL



Hook very resistant. For aluminium goal.

Reference: 060043 Unit

• HOOK FOR ALU GOAL

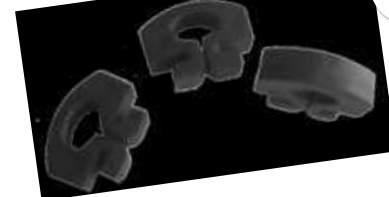

Plastic hook for alu goal with a runner. Sold by the unit. Width: 3 cm. Height: 2 cm. Thickness: 0.91 cm.

Reference: 060041 Unit

FOOTBALL FOR 8 - TRAPEZOIDAL NETS

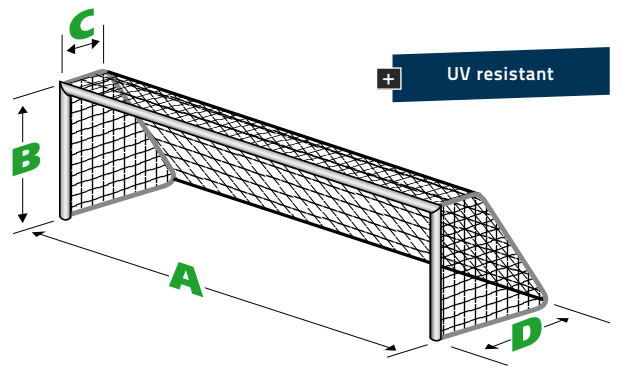

	Dimensions A x B x C x D	Knotted or knotless	Net type**	Twine size (mm)	Colours	Reference		Pair
						145 mm square mesh	120 mm square mesh	
TRAPEZOIDAL SHAPE								
GOAL TO BE SEALED	6 x 2.10 x 0.80 x 1.60 m	Knotted	Twisted PE	2 mm double	●	Ref.065001	-	
		Knotted	Braided PP	3 mm simple			Ref.065004	
		Knotted	Braided PE	3 mm simple		Ref.065123	-	
TRANSPORTABLE GOAL AND MOBILE GOAL	6 x 2.10 x 0.87 x 2.03 m	Knotted	Braided PE	3 mm simple	●	Ref.065069	-	
						Ref.065069U	-	
FOLDABLE GOAL	6 x 2.10 x 0.60 x 1.60 m	Knotted	Braided PE	3 mm simple	●	Ref.065009	-	

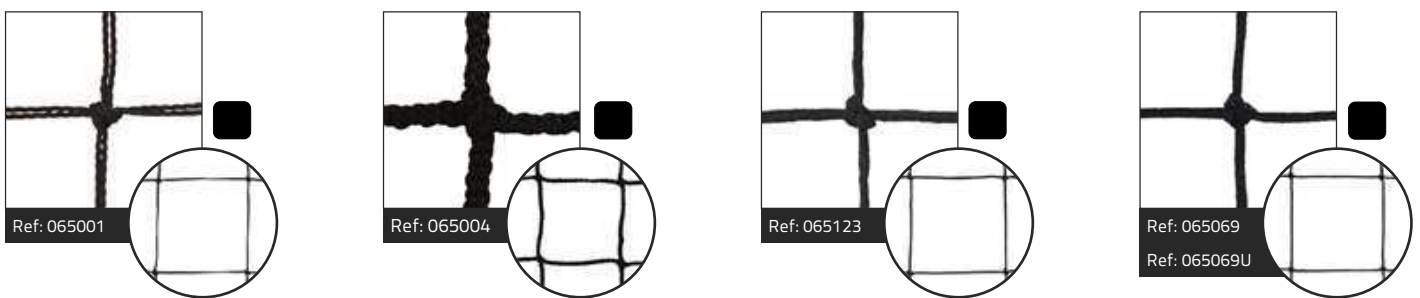

Fitted cut +

Net slightly shorter on the sides = specific dimension for folding goal.
The net doesn't drag on the ground and doesn't wrap around the du roll.

* Braided PE = braided polyethylene twine - Twisted PE = twisted polyethylene twine - PP = polypropylene

Sports bags, storage and transport

Multisports

Tracing and ground accessories

Coach, referee and player

First-aid

Fitness, bodybuilding and gym

Swimming

Combat sports

Racket sports

Athletics

Balls

School

Nets and accessories

FOOTBALL FOR 11 - TRAPEZOIDAL NETS



Goal to be sealed



Transportable goal

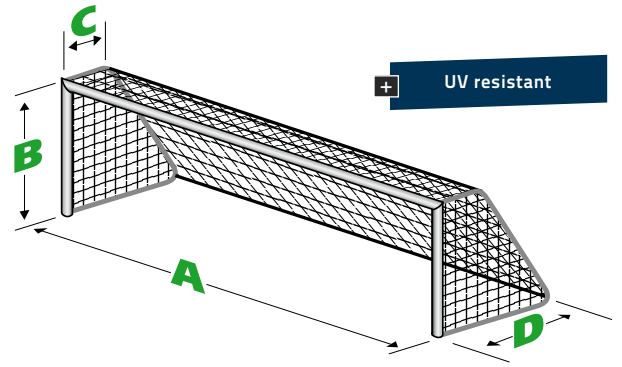

	Dimensions AxBxCxD	Knotted or knotless	Net type**	Twine size (mm)	Colours	Type of use	Reference		Pair
							145 mm square mesh	120 mm square mesh	
TRAPEZOIDAL SHAPE									
GOAL TO BE SEALED	7.50 x 2.50 x 0.80 x 2 m	Knotted	Braided PE	3 mm simple	● ○	Training, Competition	Ref.065104	-	
		Knotless	Braided PP	3 mm simple	● ○	Training, Competition	-	Ref.065005	
		Knotless	Braided PP	4 mm simple	● ● ● ● ● ● ● ●	Competition	-	Ref.065116	
TRANSPORTABLE GOAL	7.50x2.50x1x2 m	Knotted	Braided PE	3 mm simple	●	Training	Ref.065097	-	(Unit)

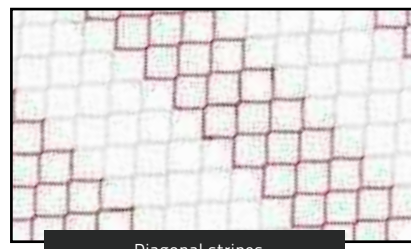
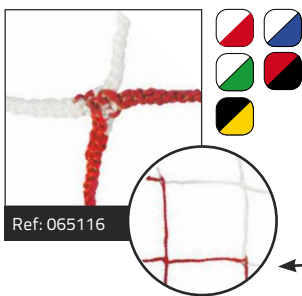
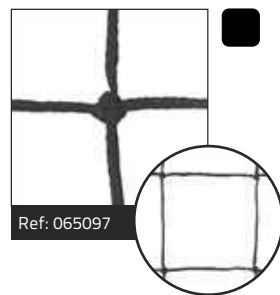
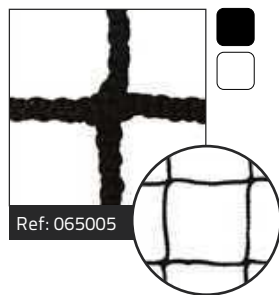
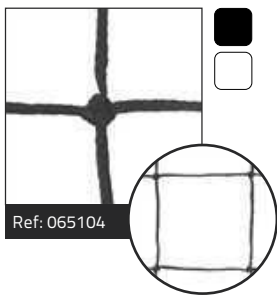

Diagonal stripes

*Braided PE = braided polyethylene twine - Twisted PE = twisted polyethylene twine - PP = polypropylene

Sports bags, storage and transport
Multisports
Tracing and ground accessories
Coach, referee and player
First aid
Fitness, bodybuilding and gym
Swimming
Combat sports
Racket sports
Athletics
Balls
School
Nets and accessories



FOOTBALL FOR 11 - EUROPEAN NETS



Goal to seal

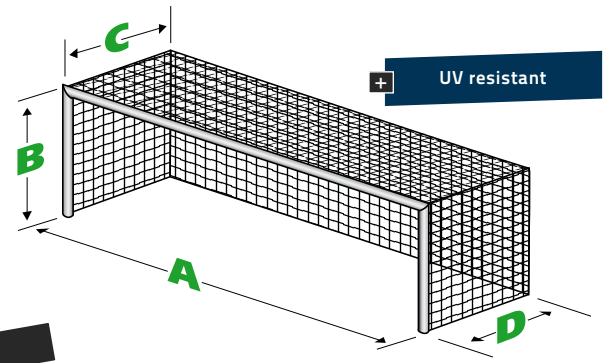

	Dimensions AxBxCxD	Knotted or knotless	Net type**	Twine size (mm)	Colours	Type of use	Reference		120 mm hexagonal mesh	Pair	
							145 mm square mesh	120 mm square mesh			
EUROPEAN FORM											
GOAL TO BE SEALED	7.50 x 2.50 x 2 x 2 m	Knotted	Braided PE	3 mm simple	<input type="checkbox"/> <input type="checkbox"/>	Competition	Ref.065209	-	-		
				4 mm simple	<input type="checkbox"/> <input type="checkbox"/>	Competition	Ref.065109	-	-		
					<input type="checkbox"/> <input type="checkbox"/>	Competition	-	Ref.065062	-	-	
		Knotless	Braided PP	4 mm simple		Competition	-	Ref.065118	-	-	
					<input type="checkbox"/>	Competition	-	-	Ref.065060 (Honeycomb)		
						Competition			Ref.065210 (Honeycomb)		

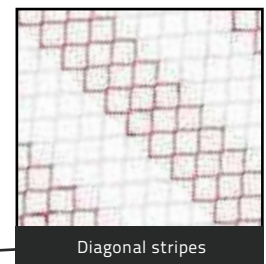
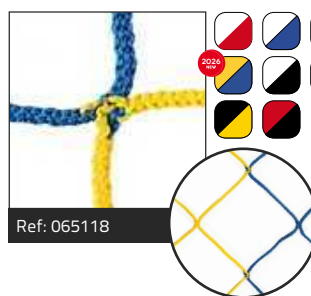
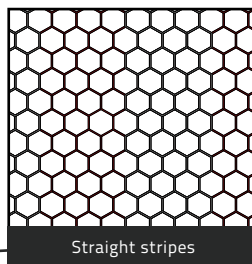
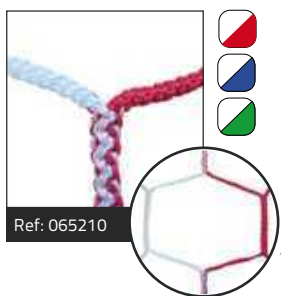
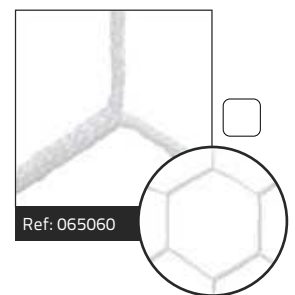
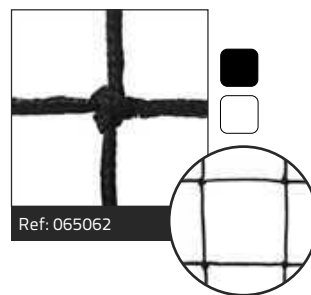
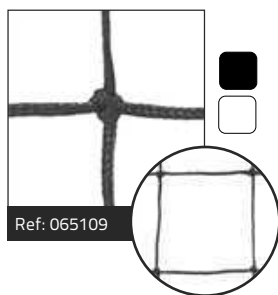
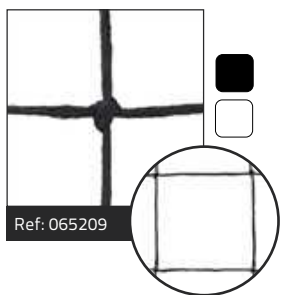

** Braided PE = braided polyethylene twine - Twisted PE = twisted polyethylene twine - PP = polypropylene

Sports bags, storage and transport
 Multisports
 Training and ground accessories
 Coach, referee and player
 First-aid
 Fitness, bodybuilding and gym
 Swimming
 Combat sports
 Racket sports
 Athletics
 Balls
 School
 Nets and accessories

BASKETBALL NETS

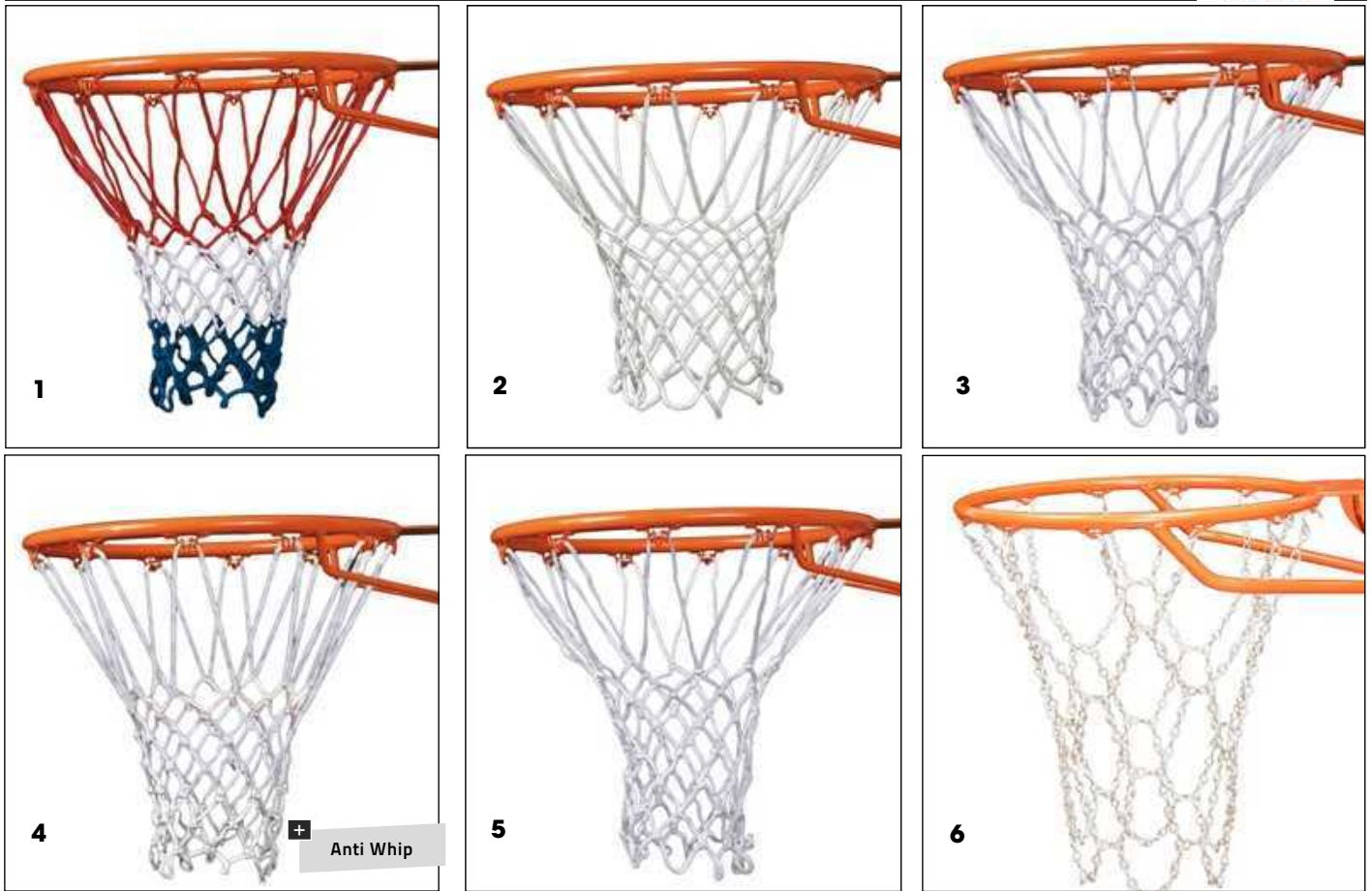

TYPE OF USE	REFERENCE	MATERIAL	TWINE SIZE (mm)	COLOURS
SCHOOL/ LEISURE	Ref.065080 (1) (Pair)	Braided Polypropylene	4	
TRAINING	Ref.065079 (2) (Pair)	Braided Nylon (polyamide)	4	
	Ref.065063 (3) (Pair)	Braided Nylon (polyamide)	6	
COMPETITION	Ref.065068 (4) (Pair)	Braided Polypropylene «anti whip»	6	
	Ref.065078 (5) (Pair)	Polyester / Braided Cotton	6	
	Ref.065082 (Pair)	Polyester / Braided Cotton	8	
URBAN	Ref.065071 (6) (Unit)	Metal Mesh (anti-vandalism)	/	/

BASKETBALL RIMS

Type of rim	Reference	Type of use	Description	Dimensions
(1) TRAINING REINFORCED RIM	064196 (1)	Training	Regulatory reinforced rim for training use. Indoor or outdoor use. Twisted net fasteners. Tube Ø: 20mm.	Circle Ø: 45 cm Weight: 5.9 kg
(2) COMPETITION REINFORCED RIM	064197 (2)	Competition	Breakaway flex basketball rim adjusted at 105 kg. Tube tie net attachment (safety strand net fastener).	Circle Ø: 45 cm Weight: 11 kg

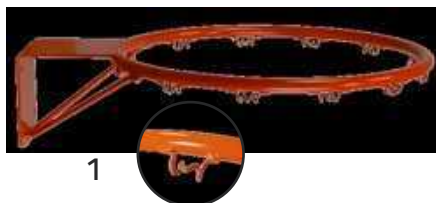

1

2

Sports bags, storage and transport
Multisports
Tracing and ground accessories
Coach, referee and player
First aid
Fitness, bodybuilding and gym
Swimming
Combat sports
Racket sports
Athletics
Balls
School
Nets and accessories



HANDBALL NETS

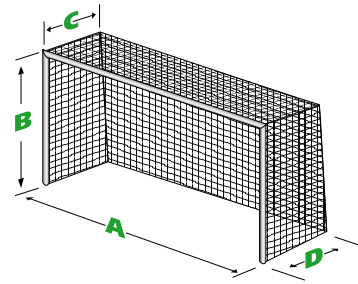

+ UV resistant

- A** = 3 m
- B** = 2 m
- C** = 0.90 m
- D** = 1.10 m

TYPE OF USE	KNOTTED OR KNOTLESS	NET TYPE (*)	TWINE SIZE (MM)	COLOURS	REFERENCE		Pair
					MESH 120 mm	MESH 100 mm	
GOAL NETS 3 X 2 X 0.90 X 1.10M							
CLUB	knotted	Twisted PE	2 mm - simple		Ref.065025	-	
			2 mm - double		Ref.065026	-	
	knotless	Braided PP	3 mm - simple		-	Ref.065211	
	knotless	Braided PP	4 mm - simple		-	Ref.065205	
					-	Ref.065006	
	knotted	Braided PE			-	Ref.065208	
SHOCK-ABSORBER NET (3 X 2 M) Delivered with a fixing line - to be positioned at 0.30 m from the bottom of the cage							
TRAINING/ COMPETITION	knotless	Braided PP	4 mm - simple		-	Ref.065139	

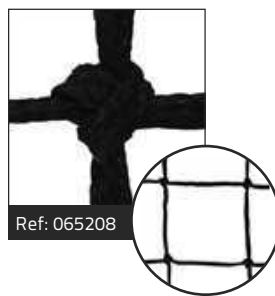
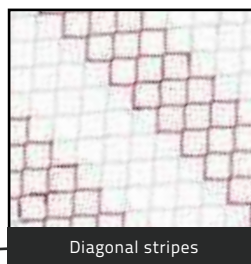
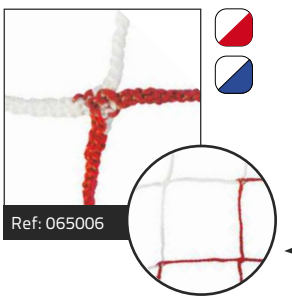
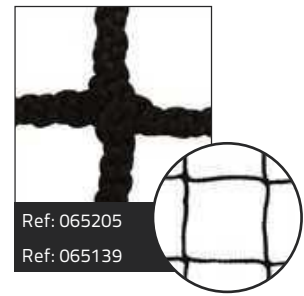
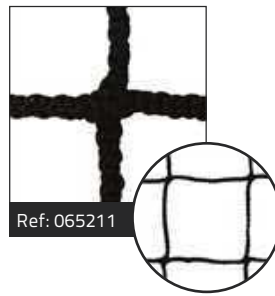
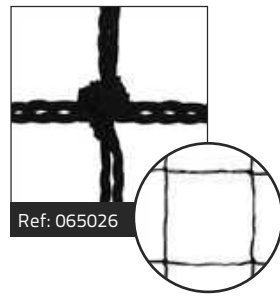
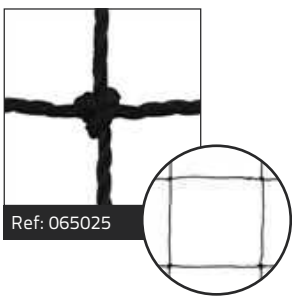

** Braided PE = braided polyethylene twine - Twisted PE = twisted polyethylene twine - PP = polypropylene



+ UV resistant



Type of use	DIMENSIONS	MESH	Net type (*)	Twine size (mm)	COLOURS	BAND	TENSION	REFERENCE	UNIT
SCHOOL/ LEISURE	H. 1.00 m	100 mm	Twisted PE	2 mm simple		110 mm white PVC band on top	Cord	Ref.065084	sold per linear meter
	9 x 0.80 m	100 mm	Twisted PE	2 mm simple		110 mm white PVC band with double stitchings on top	Cord on top and on bottom	Ref.065086 (Unit)	
TRAINING	9.50 x 1 m	100 mm	Twisted PE	2 mm simple		110 mm white PVC band with double stitchings on top	Cord on top and on bottom	Ref.065087 (Unit)	
	9.50 x 1 m	100 mm	Twisted PE	2 mm simple		110 mm white PVC band with double stitchings on top	PVC covered steel wire 6mm diameter, 12.15m length on top and cord on bottom	Ref.065088 (Unit)	
	9.50 x 1 m	100 mm	Braided PE	3 mm simple		110 mm white PVC band with double stitchings on top and 70 mm black PVC bands on 3 sides with double stitchings	PVC covered steel wire 6mm diameter, 12.15m length on top and cord on bottom	Ref.065089 (Unit)	
COMPETITON	9.50 x 1 m	100 mm	Braided PE	3 mm simple		110 mm white PVC band with double stitchings on top and 70 mm black PVC bands on 3 sides with double stitchings	PVC covered steel wire 6mm diameter, 12.15m length on top and tension straps on bottom	Ref.065090 (Unit)	
	9.50 x 1 m	100 mm	Braided PP Knotless-reinforced at the ends by fiberglass bar	4 mm simple		150mm white PVC band with foam with double stitchings on top / 110 mm white PVC band with double stitchings on bottom / 70mm black PVC band with double stitchings on sides.	PVC covered steel wire 6mm diameter, 12.15m length on top / brackets blocking the net on top and on the middle / tension straps on bottom	Ref.065092 (Unit)	

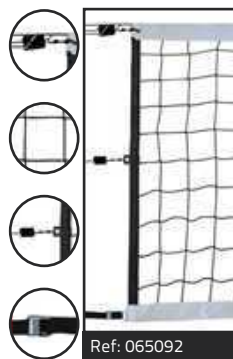
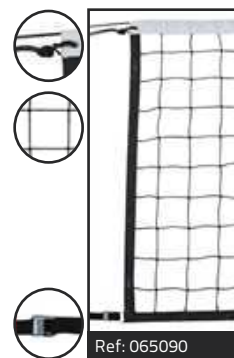
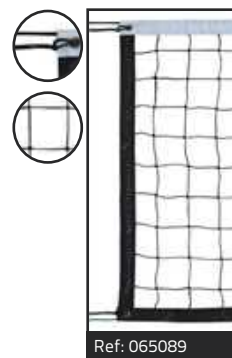
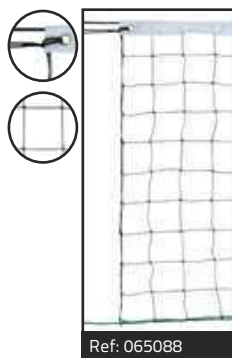
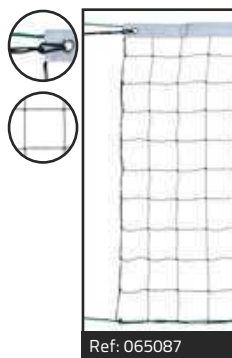
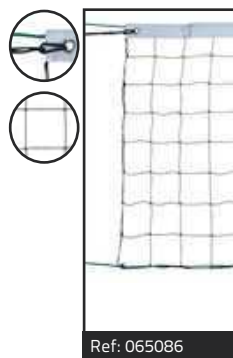

+ For competition nets, it is imperative to use vertical strips with antenna screw system or support antenna screw system that can be received MD1/A or MD2/A rods.

PLASTIC NET HANGER

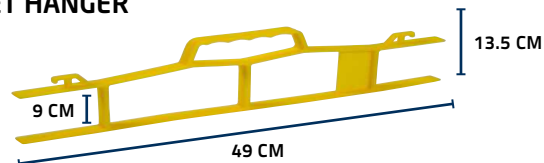

Plastic net hanger perfect to wind and transport your net.

Reference: 012025

Unit



Sports bags, storage and transport
Multisports
Tracing and ground accessories
Coach, referee and player
First aid
Fitness, bodybuilding and gym
Swimming
Combat sports
Racket sports
Athletics
Balls
School
Nets and accessories

REGULATORY ANTENNAS



SET OF 2 STRAPS



RECYCLABLE
DIAMETER 10 mm
LONGUEUR 50 cm

With closed buckle for the tension of the net.

Reference: 022109 Set of 2

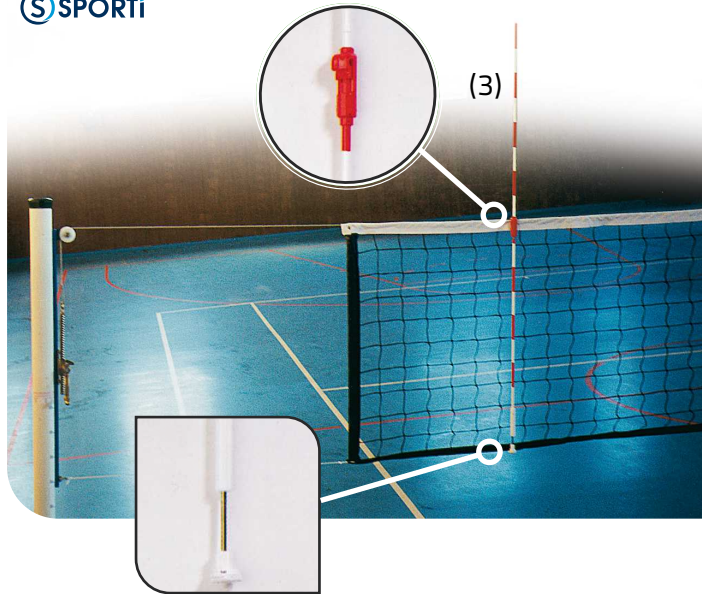

REPLACEMENT CABLE



RECYCLABLE
DIAMETER 5 mm
LONGUEUR 12.15 m

Coated steel replacement cable.

Reference: 060121 Unit

Type of use	Specificities	Ref	Description
Training	Fixed	069211 (1)	2 rods of 180 cm, Ø 9,5 mm in fiberglass + 2 fixing supports (Hook and loop fastener covers). Pair.
Training	Assembled	069212 (2)	2 rods of 180 mm, Ø 9,5 mm in fiberglass + 2 fixing supports (Hook and loop fastener covers). Pair.
Competition	With screw system	069210 (3)	Approved by the FIVB. They can be fixed directly on the net with a clamp on the top and the bottom. 180 cm, Ø 9,5 cm, with transport bag. Pair.
Pair of covers for antennas	-	069213	One Hook and loop fastener on top and one Hook and loop fastener on bottom. Pair.



BEACH VOLLEYBALL

BEACH VOLLEYBALL NETS



DIMENSIONS	MESH	Net type	Twine size	COLOURS	BAND	TENSION	REFERENCE
9.50 x 1 m	100 mm	Twisted PE	3 mm simple	■	Neon Yellow PVC band around the net	Cord	Ref.065093 (1)
			2 mm simple			Steel wire	Ref.065094

(1)



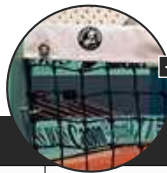

Roland Garros supplier



RECYCLABLE

UV resistant

TENNIS NETS

DIMENSIONS	MATERIAL	MESH (mm)	TWINE SIZE (mm)	COLOURS	BAND	TENSION	REFERENCE	SPECIFICITIES	UNIT
12.70 x 1.07m	Braided PE* knotted	SIMPLE 45 mm	3 mm		Polyester (PES) 110 mm white with 4 topstitches	PVC covered steel wire 6 mm diameter on top and cord on bottom	065107	110 mm black PVC* band on sides and 80 mm on bottom	
	Twisted PE* knotted	6 rows of 45mm double mesh	2 mm		110 mm white PVC* with 2 topstitches	PVC covered steel wire 6 mm diameter on top and cord on bottom	012084	-	
	Braided PE* knotted	6 rows of 45mm double mesh	3 mm		Polyester (PES) 110 mm white with 4 topstitches	PVC covered steel wire 6 mm diameter on top and cord on bottom	012086	-	
	Braided PE* knotted	7 rows of 40mm double mesh	3 mm		110 mm white PVC* with 4 topstitches	PVC covered steel wire 6 mm diameter on top and cord on bottom	Model used on Roland Garros' courts 065105	80 mm black PVC band on bottom	

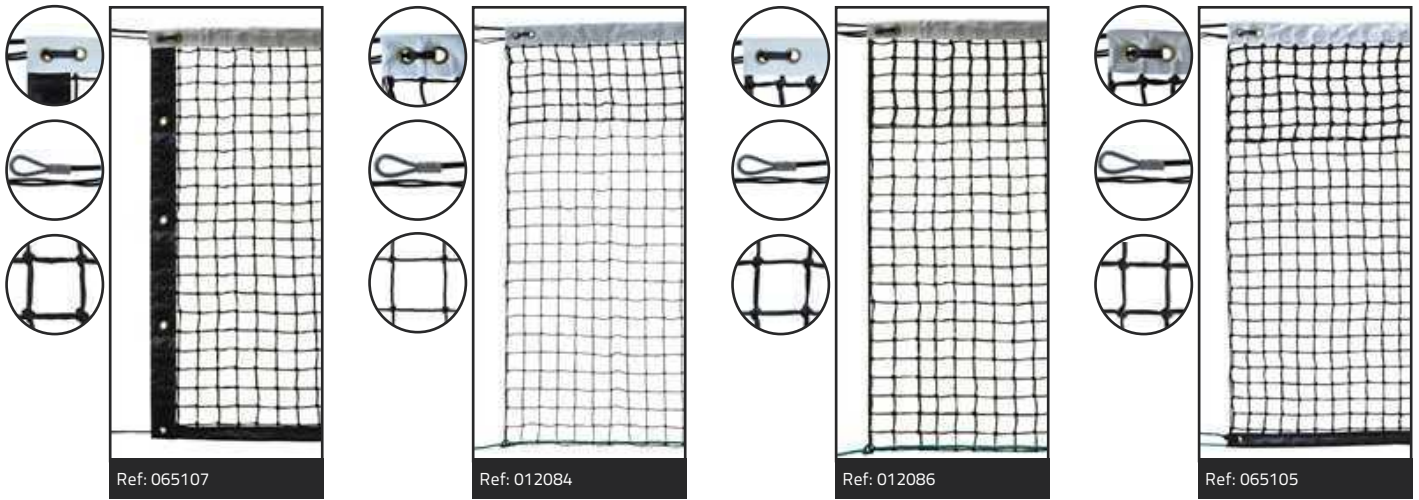

*PE= POLYETHYLENE / PVC= Polychlorure de vinyle

TENNIS ACCESSORIES

PLASTIC NET HANGER

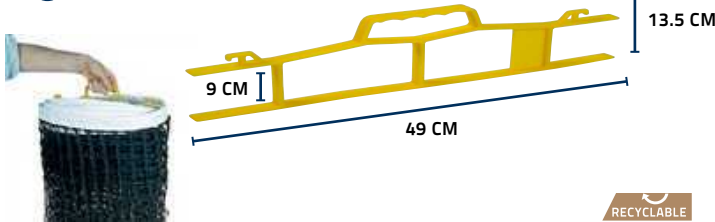

RECYCLABLE

Plastic hanger for net.

Reference: 012025

• SPARE BAND WITH EYELETS



RECYCLED

With tie rope.

Reference: 012028

REGULATOR



RECYCLABLE

Polyester straps of 50 mm. Adjustment by hook and loop fastener with metal hook.

Reference: 012027

SPARE CORD



RECYCLABLE
DIAMETER 5 mm

PVC covered steel wire. Length 13.7 m. Ø 5 mm.

Reference: 012026

Sports bags, storage and transport
Multisports
Tracing and ground accessories
Coach, referee and player
First aid
Fitness, bodybuilding and gym
Swimming
Combat sports
Racket sports
Athletics
Balls
School
Nets and accessories



BADMINTON NETS									
TYPE OF USE	DIMENSIONS	MESH (mm)	TWINE SIZE (mm)	COLOURS	BAND ON THE TOP	BAND AROUND	REF	SPECIFICITIES	UNIT
TRAINING	6.02 x 0.76 m	19mm polyamide knotted	1.2 mm	Brown	80mm white PVC with double stitchings	30mm nylon black	011064	Braided cord (3.5mm diameter - 8.5m L) on top and cord fastener on bottom	
COMPETITION		19mm polyamide knotted	1.6 mm	Brown	80mm white PVC with double stitchings	30mm nylon black	011065	Braided cord (4mm diameter - 8.5m L) on top and cord fastener on bottom	
HIGH - LEVEL COMPETITION CERTIFIED		19mm polyamide knotted	1.6 mm	Brown	80mm white PVC with double stitchings	40mm black nylon with double stitchings	011066	4 Hook and loop fastener fastener on each side - braided cord (4mm diameter - 8.5m L) on top and cord fastener on bottom	
		19mm polyamide knotted	1.6 mm	Brown	80mm white PVC with double stitchings	40mm black PVC with double stitchings	011057	Framing bar in fiberglass on each side - braided cord (4mm diameter - 8.5m L) on top and cord fastener on bottom	

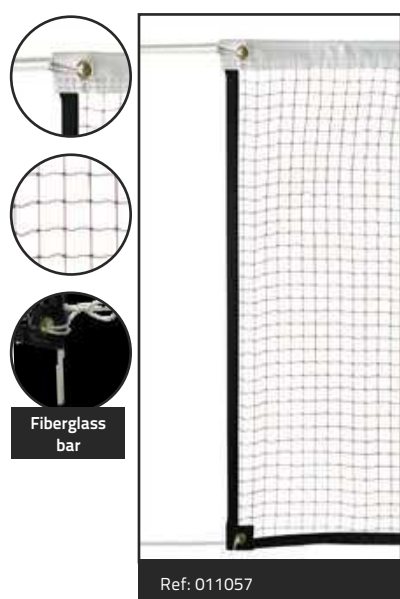
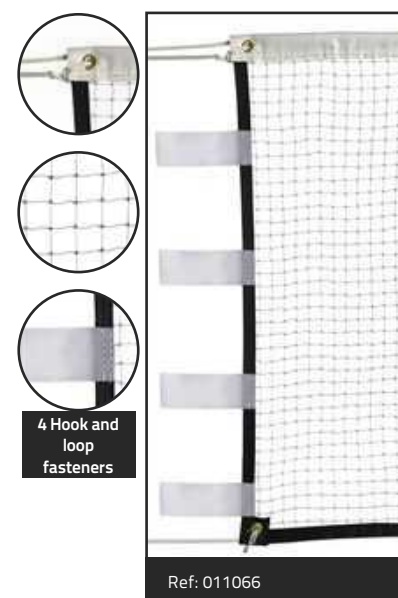
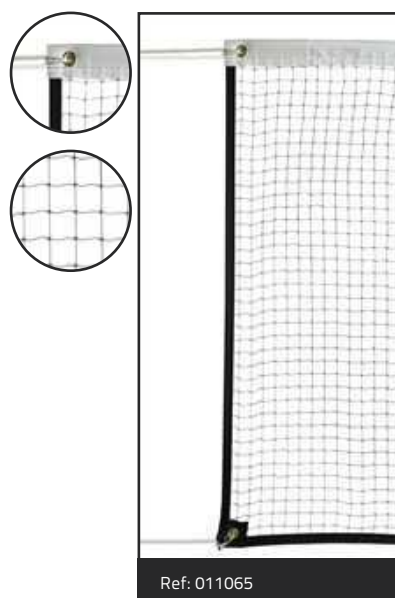
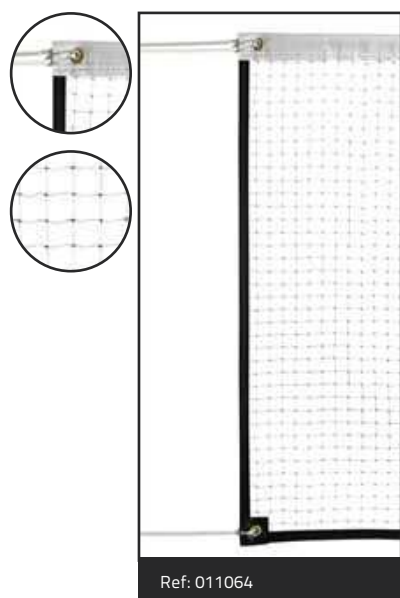

Sports bags, storage and transport

Multisports

Tracing and ground accessories

Coach, referee and player

First aid

Fitness, bodybuilding and gym

Swimming

Combat sports

Racket sports

Athletics

Balls

School

Nets and accessories

INDEX

A		
11-a-side football net	184-185	
25 m elastic cord roll	182	
3 m elastic	179	
8-a-side football net	183	
Ab wheel	116	
Absorbent cotton	106	
Adhesive bandage	105	
Adhesive tape	104	
Aerobic sprint ring	172	
Aerobic super disc	172	
Agility and precision kit	177	
Agility kit	177	
Alcohol	107	
American football	157	
Anti-chafing cream	103	
Aquastep	115-129	
Aquatic belt	129	
Arch	27	
Armband	16-74-75	
Arnica	102-103	
Arnica cream	103	
Arnica cryo gel	103	
Arnica massage oil	102	
Arnica sachet	107	
Athletics	145 to 150	
Athletics marking sheet	147	
B		
Baby floor-standing basketball hoop	48	
Baby handball kit	45	
Backpack	7-64	
Badminton	138 to 140	
Badminton net	191	
Badminton racket	138	
Badminton racket bag	6-139	
Badminton shuttlecock	138	
Balance beam	178	
Balance board	114-178	
Balance dome	114	
Balance foam	114	
Balance game	178	
Ball and tyre repair spray	72	
Ball bag	8	
Ball carry net	8	
Ball needle	72	
Ball pick-up trolley	144	
Ball rack	9	
Ball trolley	144	
Ball trolley	9 to 12	
Balloon	161	
Base	26	
Base plate	55	
Basketball arrow marker	82	
Basketball goal	48-49	
Basketball hoop	48-49	
Basketball initiation kit	48	
Basketball net	186	
Basketball shooting glasses	48	
Basketballs	154	
Battery	91	
Battle rope	118	
Beach ball racket	174	
Beach handball	156	
Beach soccer ball	152	
Beach volleyball	156	
Beach volleyball kit	51	
Beach volleyball net	188	
Beach volleyball post	189	
Beachminton	140	
Beachminton racket	140	
Bean ball	170	
Bear paw mitt	124	
Beginner ball	160	
Beginner hammer	146	
Beginner shot put	146	
Bell ball	153	
Bib holder	14	
Blind football	153	
Blind football	153	
Blower	73-162	
Bolas	171	
Boomerang	172	
Boot scraper	55	
Bottle	61 to 63	
Bottle carrier	62-63	
Bottle label	61	
Bouncing ball	161	
Boundary tape	166	
Box of 7 giant chalks	176	
Boxing gloves	124	
Boxing headguard	124	
Bucket, spade and accessories	181	
C		
California training kit	51	
Camphorated massage oil	102	
Canister	61	
Card	81	
Care towel	107	
Care wipe	107	
Cast iron fixing block	56	
Cast iron weight	50-149	
Cast iron weight plate	116	
Catcher ball	174	
Cestas	174	
Chinese plate	171	
Chlorhexidine	107	
Clamp	27	
Coach backpack	7-64-167	
Coach board	68-69	
Coach's notebook	65	
Cohesive bandage	105	
Cold spray	101	
Coloured weight plates	116	
Comet ball	175	
Compass	164	
Compressor	73	
Cone	18-19-166	
Control punch	165	
Cooler	61-96	
Corner and rugby post	54	
Countdown timer	94	
Cream/gel display stand	103	
Crepe bandage	106	
Cross-training box	118	
Cup and medal	52	
Curl bar	116	
D		
Deck tennis ring	173	
Devil stick	171	
Diabolo	171	
Direction-of-play marker	82	
Discovery target	173	
Discus	147	
Display board	94-95-96	
Display remote control	96	
Document holder	64-167	
Dumbbell	117	
Dumbbell bar	116	
Dumbbell rack	117	
Dummy	32-33-34	
Dummy trolley	33	
E		
Ear plugs	130	
Educational ball	113-160-161	
Elastic	144	
Elastic bandage	106	
Elastomer band	56	
Electronic substitution board	80-94	
Electronic whistle	77-167	
Elephant-skin ball	113-159	
Elephant-skin balloon	113-159	
Emergency kit	97 to 100	
Equipment bag	7	
Escape belt	31	
Extra-flat hoop	20	
F		
FFDF flying disc	173	
Film roll	102	
First-aid kit	98 to 100	
First-aid pouch	96-97	
First-aid room furniture	108	
Fitness	110 to 123	
Fitness resistance band	121	
Fitness roller	113	
Fixing base	26	
Flag belt	16	
Flat band	121	
Flat hoop	20	
Flexi-basket kit	48	
Flexible dummy	33	
Floating basket	130	
Floating water polo goal	130	
Floor cleaner	60	
Floor marking adhesive tape	22	
Florida competition kit	51	
Flying ball	174	
Flying disc	146-173	
Flying disc goal	173	
Flying ring	173	
Foam ball	141-159	
Foam ball	158-159	
Foam die	172	
Foam javelin	146-175	
Foldable badminton kit	140	
Foldable football goal	37-38-39	
Foldable futsal goal – Flexi Goal	38	
Foldable handball goal	45-46-47	
Foldable magnetic board	71-167	
Folding table	109	
Football	152-153	
Football corner target	35	
Football Flexi-goal	39	
Football Flexi-goal	39	
Football goal target	35	
Foul board	82	
Fox 40® whistle	78-79	
Futnet kit + reel	37	
Futsal ball	152	
G		
Galaxy tennis ball	141	
Giant ball	162-175	
Giant chalk	176	
Glycerine	72	
Go Go 4 wheels	178	
Goal hook	182	
Goal weighting bag	40	
Ground imprint	22-23	
Ground marking	22-176	
Ground marking	22-23-176	
Ground marking kit	23-176	
Gym bag	5	
Gym ball	113	
Gym ball stand	113	
Gym mat	111	
Gym tube	121	
Gymnastics ball	126	
Gymnastics rope	122	
H		
Hand grip	116	
Hand whistle	77-167	
Handball	155	
Handball cleaning cream	60	
Handball corner target	44	
Handball Flexi-goal	47	
Handball Flexi-goal	47	
Handball goal reducer	44	
Handball goal reducer tarp	44	
Handball goal target	44	
Handball goal target with self-weighted base	44	
Handball initiation kit	47	
Handball net	187	
Handball timeout sheet	82	
Heat patch	101	
Hedgehog ball	113-161	
Hemp rope	123	
Hex dumbbells	117	
Hockey	168-169	
Hopper ball	162-175	
Hurdle	28-29-148	
Hydroalcoholic gel	107	
I		
Ice bladder	100	
Indiaka	174	
Inflatable basketball/handball dummy	48	
Inflatable dummy	34	
Inflatable rugby dummy	51	
Inflatable sandball goal	46	
Inflation accessory	72-73	
Inflation nozzle	72	
Infrared thermometer	107	
Instant cold pack	101	
J		
Javelin	147	
Javelin bag	6-147	
Jersey / shorts bag	7	
Judo	125	
Judo belt	125	
Juggling	170-171	
Juggling ball	170	
Juggling club	126-170	
Juggling club	126-170	
Juggling ring	170	
Juggling scarf	170	
Jump elastic	150	
Junior dummy	33	
K		
Karate	125	
Karate belt	125	
Kettlebell	119	
Kimono	125	
L		
Lap counter	76-150	
Large-format basketball board	82	
Latex band	121	
LCD score display	94	
Leisure frisbee	173	
Line marker	57	
Line-marking trolley	57	
Loudhailer	76-150-167	
Luggage	4 to 12	
M		
Magnesium chalk	60-147	
Magnetic marker	71	
Manipulation ball	126	
Map holder	165	
Map measurer	165	
Marker cone	21	
Marker pole	26	
Marking disc	21	
Marking implant	56	
Marking slat	23	
Marking spray	58-166	
Marking tape roll	22	
Massage ball	115-161	
Massage oil	102	
Massage roller	113	
Mat	110-111	
Mat carrier	12	
Mat holder	12-111	
Mat storage bag	12-111	
Mat transport elastic	111	
Mat/carpet bag	111	
Measuring device	76	
Measuring tape (decimetre)	76-150	
Medal	52	
Medical armband	75-108	
Medicine ball	122	
Megaphone	76-150-167	
Metal storage trolley	9	
Mini football goal	37 to 43	
Mini handball goal	45	
Mini tennis racket	174	
Mini vortex	146-175	
Mini-tennis / tennis-ball / futnet kit	36-144	
Mobile storage cabinet	11	
Motor skills case	23-176	
Motor skills kit	177	

INDEX

Multi-ball rubber ball	160	Road safety sign	180	Team foul indicator	82
Multi-game brick	178	Rolla Bolla	178	Tennis ball	141
Multi-marker	21	Rotating whiteboard	71	Tennis net	191
Multi-purpose bag	5	Round hoop	20	Tennis net hanger	190
Multi-shape ball	161	Rugby ball	157	Tennis net target	143
Multi-sport bag	4 to 8	Rugby ball bag	8	Tennis net tensioner	190
Multi-sport ball	160	Rugby tee	51	Tennis racket	142
Multi-sport podium	52-150			Tennis racket bag	6-143
Multi-sports	13 to 52			Tennis score display	144
N					
Nasal protection mask	104	Sack race	179	Throwing games	172 to 175
Nasal tampons	106	Safety vest	16	Throwing ring	173
Net storage bag	6	Sandbag	119	Time display	94 to 96
Nose clip	130	Scarf	16	Timer printer	91
Numbered ground markers	22-176	School parachute	179	Timer printer paper roll	90
Numbered ground marking	22-176	School traffic lights	180	Timer start handle	92
O					
Octagonal hoop	24	Scissors	106	Timer with printer	92
Odometer	76-150	Scorer	82	Toiletry bag	5
Oriental balm	102	Self-gripping fastening strap	27	Topkari	174
Orienteering	164 to 166	Self-weighted football goal target	35	Touchline flag	81
Orienteering control card	165	Sensory ball	160	Training ball	118
Orienteering kit	165-166	Sensory game	177	Training bib	14 to 16
Orienteering kit case	166	Set of 10 numbered cone covers	18	Training dome	114
Orienteering marker	165	Set of 14 flexible rugby touchline poles	54	Training javelin	147
Oximeter	107	Set of 20 extra-soft marking rings	21	Training kit	17-27
P					
Paint	58	Set of 4 beginner ropes	122	Training kit	24-149
Pair of clubs	126	Set of 4 loops and pegs	56	Training torso	48
Pair of scissors	106	Set of 5 foul cards	82	Trampoline	114
Pair of stilts	178	Shield	51	Tripod	71
Parachute	50-149	Shoe bag	5	Trolley bag	4
Parallel bars	118	Shoe brush	55	Tube bag	8
PC/Stopwatch data transfer software	90	Shoe cleaner	55	Tube of badminton shuttlecocks	138
Pear whistle	77-167	Shot	147	Tunnel	179
Pencil	67	Skipping rope	122	U	
Pennant	55	Skyfloater ball	162	Ultra-light ball	113-161
Perforated ball	160	Slackline	176	Ultra-light straw ball for tennis	141
Perforated ball	161	Slalom pole	25	Unihockey	168
Pétanque	50	Slalom pole bag	6-25	Unihockey ball	168
Pétanque bag	9	Soft rugby ball	157	Unihockey stick	168
Physio armband	75-108	Soft weighted ball	146	V	
Physio bag	96-99	Speed badminton racket	140	Vaseline	102
Pickleball	132 to 135	Speed badminton shuttle	140	Velpeau strapping bandage	105
Pickleball kits	134-135	Speed ladder	24-149	Ventilated bag	8
Pilates ring	113	Speedminton	140	Vision-blocking mask	153
Pitch marking kit	22-23	Spiked disc	114	Volleyball	156
Plaq/Tube	51	Splinter tweezers	106	Volleyball antenna	189
Plaster	104	Sportbeeper	93	Volleyball net	188
Plaster box	104	Sports adhesive	60	Volleyball net hanger	188
Player substitution system	80	Sports bag	4 to 8	Volleyball post	189
Playground game	178-179	Sports tape	105	Vortex javelin	146-175
Plyometric box	118	Starting blocks	148	W	
Plyometric platform	118	Step	115	Wall ball	119
Plyometrics	118	Step riser	115	Wall-mounted hoop holder	12
Pop-up football goal	41	Sterile compress	104	Warming gel	103
Pop-up handball goal	45	Steri-strip	104	Water bottle	61
Poster stand	66-167	Stilts	178	Water polo ball	130-157
Poultice	102	Stopwatch	84 to 92	Water polo goal net	130
Power band	121	Stopwatch case	84-85	Weight collar	116
Power speed	50-149	Stopwatch fixing clip	91	Weighted bar	116
Precision kit	177	Stopwatch pouch	91	Weighted or non-weighted training kit	27
Pressure gauge	72	Stopwatch watch	80-86-165	Weighted swimming disc	130
Printer paper for timer	90	Storage bin	10	Weighted swimming hoop	130
Pro coaching board	69	Storage trolley	9 to 11	Weighted swimming ring	130
Protective foam	105	Storage trunk	10	Weighted vest	51-119-149
Protective glove	106	Straw ball	115-161	Weighted wrist strap	117
Pull buoy	129	Street hockey ball	168	Weightlifting bar	116
Pump	72-73-162	Street hockey puck	168	Wheeled bag	4-7
Punch mitt	124	Street hockey stick	168	Whistle	77 to 79-167
Push-up	116	Strength clamp	116	Whistle lanyard	77
Push-up handles	116	Stretcher	108	Whiteboard cleaner	71
Puzzle mat	125	Survival blanket	106	Wooden stick	26-126
PVC pétanque boule	179	Swim boxer shorts	128	Y	
PVC sleeve	55	Swim briefs	128	Yoga	112
R					
Racket game	174	Swimming armbands	130	Yoga belt	112
Rebound board	36	Swimming belt	129	Yoga brick	112
Reel	55	Swimming cap	128	Yoga mat	112
Referee marker	81	Swimming goggles	128	Yoga strap	112
Referee watch	80	Swimming noodle	129	Yoga wheel	112
Refereeing pouch	80	Swimming stopwatch	130		
Refereeing set	81	Swimming training board	129		
Relay baton	148	Swimming training equipment	129		
Replacement cable for tennis net	190	Swimming training fins	129		
Replacement cable for volleyball net	189	Swimsuit	128		
Replacement eyelet band for tennis net	202	T			
Resin	60	Table tennis ball	137		
Resistance band	121	Table tennis marker	137		
Resistance harness	51-121-149	Table tennis net	137		
Reusable hot/cold compress	101	Table tennis post	137		
Reusable hot/cold pad	101	Table tennis racket	136-137		
Rhythmic gymnastics	126	Table tennis racket bag	6-137		
Rhythmic gymnastics clubs	126	Tackle bag	51		
Rhythmic gymnastics competition ball	126	Tactical board	70-71-167		
Rhythmic gymnastics discovery ribbon	126	Tactical board cover	71		
Rhythmic gymnastics training ball	126	Taktifol	67		
Rhythmic gymnastics training ribbon	126	Takti-foot kit	67		
River stone	177	Tape measure	76-150		
		Tatami mats	125		
		Tchoukball	30		
		Tchoukball kit	30		

Photos and articles descriptions can be provided for information purposes only and not constitute at all a contractual document.

Images credits: categories pages: Adobe Stock, ISTOCK and Sportifrance. / Products visuals: Suppliers, partners and Sportifrance. - Conception / Realisation : Sportifrance

Catalogue published by Sportifrance, ZI Le Pironnet, 85120 La Châtaigneraie, France. SIRET: 50425070500036 / RCS 504 250 705 in La Roche sur Yon

The reproduction of this catalogue, is prohibited without prior authorization from the author. / © Sportifrance - 2026

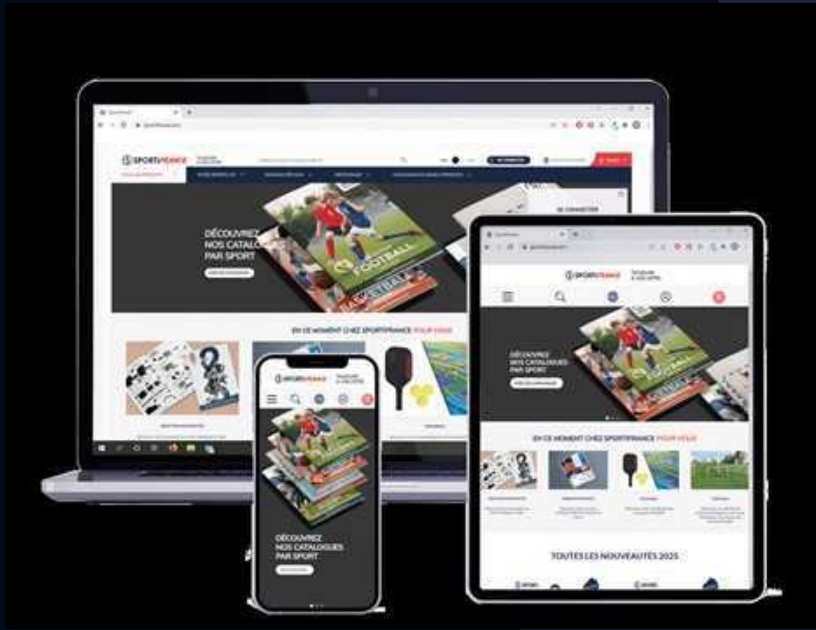

Site internet / Website
www.sportifrance.com

AVAILABLE ON
 computer, tablet and cell phone



SPORTIFRANCE - ZI LE PIRONNET - 85120 LA CHÂTAIGNERAIE - FRANCE - +33 (0)2 51 699 800

